

Automation

Contactors - CWM Line

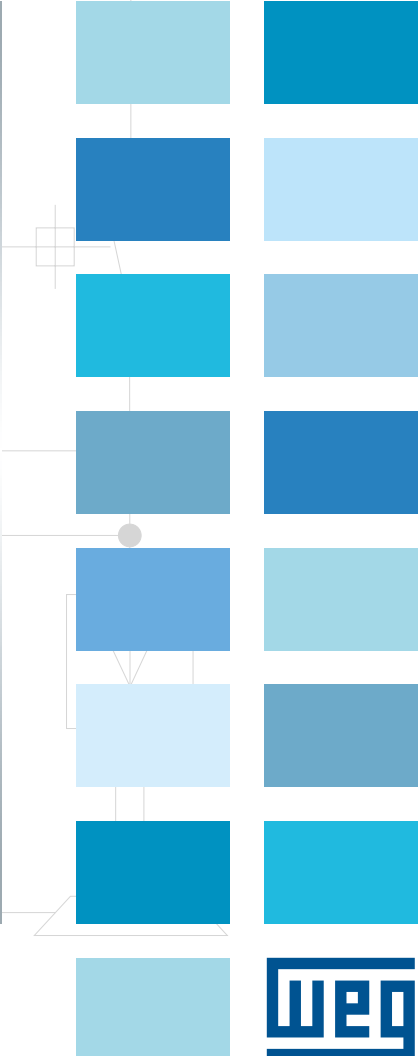

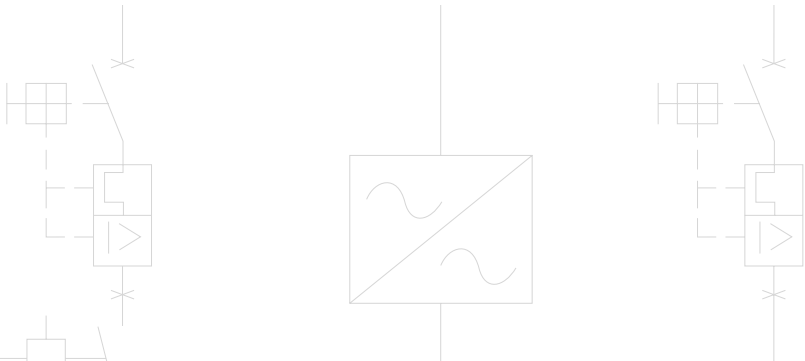

WEG CWM40
EC 90 VDE 60364-41
R1-2EA
COP/AN/IN 11A
TOSHA LAR 10
AC3
V C20 400 400 500 600
V C20 200 400 400 400
V 11 11 22 22 22 22
IP 15 15 20 20 20 20

IP	1	3	6
110V	3	3	3
230V	6	6	6
230V	10	10	10
400V	15	15	15
575V	25	25	25

UL LISTED
RQ-COMPLIANT
ELECTRICAL
EQUIPMENT FOR USE IN
INDUSTRIAL AND COMMERCIAL
POWER DISTRIBUTION SYSTEMS
FOR THE DATA AND CONTROL
CIRCUITS

RAM
EC 90-17 - 2011
MADE IN BRAZIL

WEG CWM105
EC 90 VDE 60364-41
R1-2EA
COP/AN/IN 11A
TOSHA LAR 10
AC3
V C20 400 400 500 600
V C20 200 400 400 400
V 11 11 22 22 22 22
IP 15 15 20 20 20 20

IP	1	3	6
110V	3	3	3
230V	6	6	6
230V	10	10	10
400V	15	15	15
575V	25	25	25

UL LISTED
RQ-COMPLIANT
ELECTRICAL
EQUIPMENT FOR USE IN
INDUSTRIAL AND COMMERCIAL
POWER DISTRIBUTION SYSTEMS
FOR THE DATA AND CONTROL
CIRCUITS

RAM
EC 90-17 - 2011
MADE IN BRAZIL

WEG CWM18
EC 90 VDE 60364-41
R1-2EA
COP/AN/IN 11A
TOSHA LAR 10
AC3
V C20 400 400 500 600
V C20 200 400 400 400
V 11 11 22 22 22 22
IP 15 15 20 20 20 20

IP	1	3	6
110V	3	3	3
230V	6	6	6
230V	10	10	10
400V	15	15	15
575V	25	25	25

UL LISTED
RQ-COMPLIANT
ELECTRICAL
EQUIPMENT FOR USE IN
INDUSTRIAL AND COMMERCIAL
POWER DISTRIBUTION SYSTEMS
FOR THE DATA AND CONTROL
CIRCUITS

RAM
EC 90-17 - 2011
MADE IN BRAZIL

1L1 3L2 5L3
WEG CWM250
2T1 4T2 6T3

Contactors - CWM Line

Summary

Presentation	4
Accessories Overview	5
Three-Pole Contactors from 9 up to 250 A (AC-3) - AC Coil	9
Three-Pole Contactors from 40 up to 105 A (AC-3) - DC Coil	10
Three-Pole Contactors from 112 up to 800 A (AC-3) - Coil with Electronic Module AC/DC	11
Four-Pole Contactors - AC Coil or Coil with Electronic Module AC/DC	12
Accessories	13
Reversing Starters	16
Star-Delta Starters	17
Spare Parts	18
Technical Data	19
Dimensions (mm)	39

CWM Contactors - Presentation

The CWM general-purpose contactor line has been designed taking into consideration industrial duty and reliability.

Rated for inductive loads up to 800 A or 440 kW @ 380/400 V, WEG can offer the most suitable contactor for your application.

CWM contactors allow total panel space optimization, with only a few compact frame sizes from 4 to 440 kW @ 400/415 V. Reducing inventory is simple with CWM common accessories. For example, side-mounted auxiliary contact blocks are the same from 9 to 300 A (AC-3) @ 440 V.

Designed for extended mechanical and electrical life, dependable switching in even the most heavy-duty applications can be achieved. No matter how demanding the application, all WEG contactors are tested and approved to be used under Type 1 and Type 2 short-circuit coordination.

Ensuring global acceptance, all components conform to UL 508 (USA and Canada), IEC 60947 and CE.

All WEG contactors are manufactured to assure the highest quality manufacturing processes and component materials.

This way, WEG offers reliable solutions for low-voltage applications in electric panel assemblers, OEMs, distributors and end users.



CWM Contactors from 9 up to 40 A (AC-3) - Accessories Overview

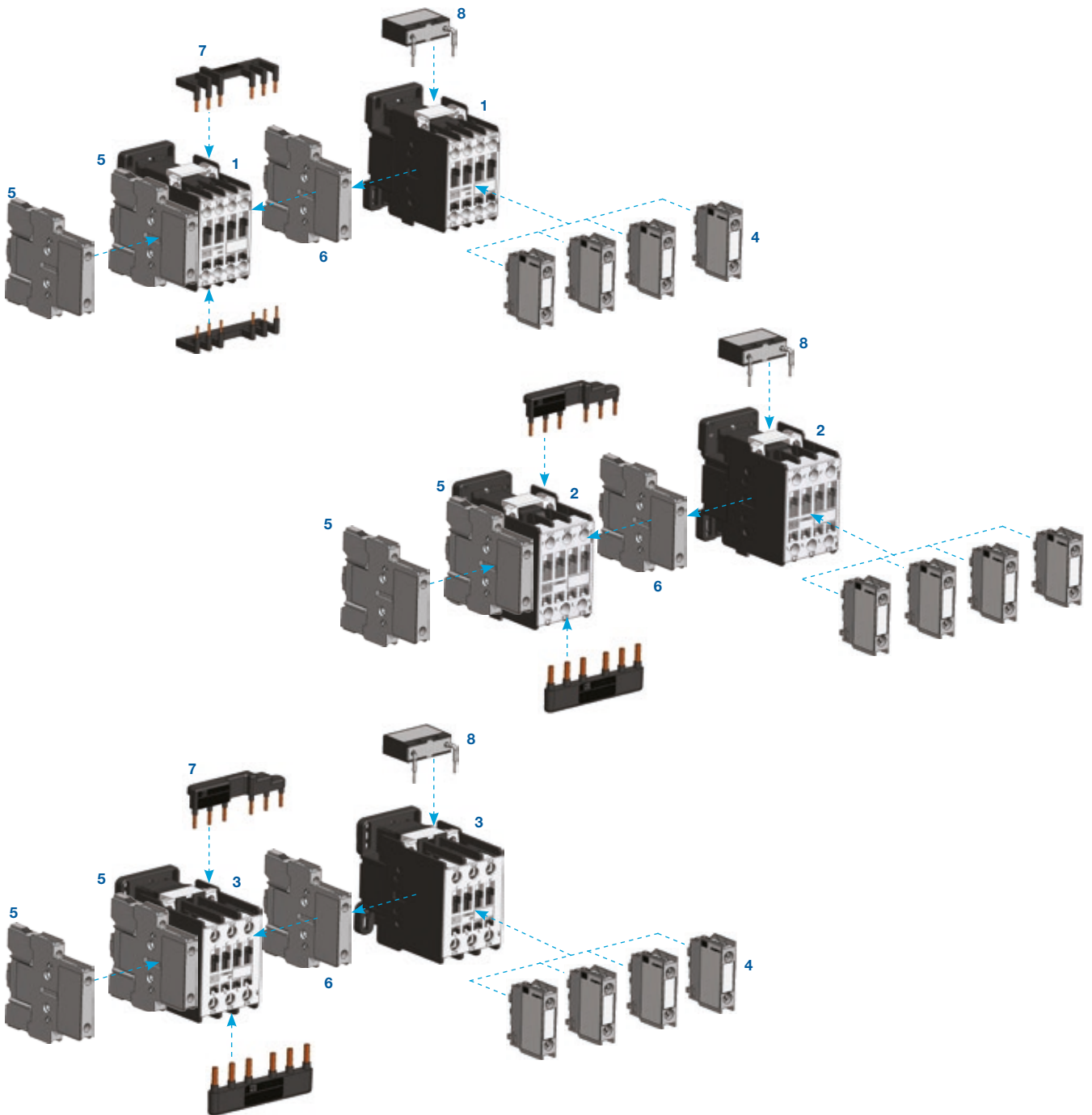

- 1 - Contactors CWM9...18
- 2 - Contactors CWM25
- 3 - Contactors CWM32/40
- 4 - Front mounting auxiliary contact block BCXMF
- 5 - Side mounting auxiliary contact block BCXML
- 6 - Mechanical interlock block BLIM
- 7 - Easy connection busbar
- 8 - Surge suppressor blocks BAM

CWM Contactors from 50 up to 105 A (AC-3) - Accessories Overview

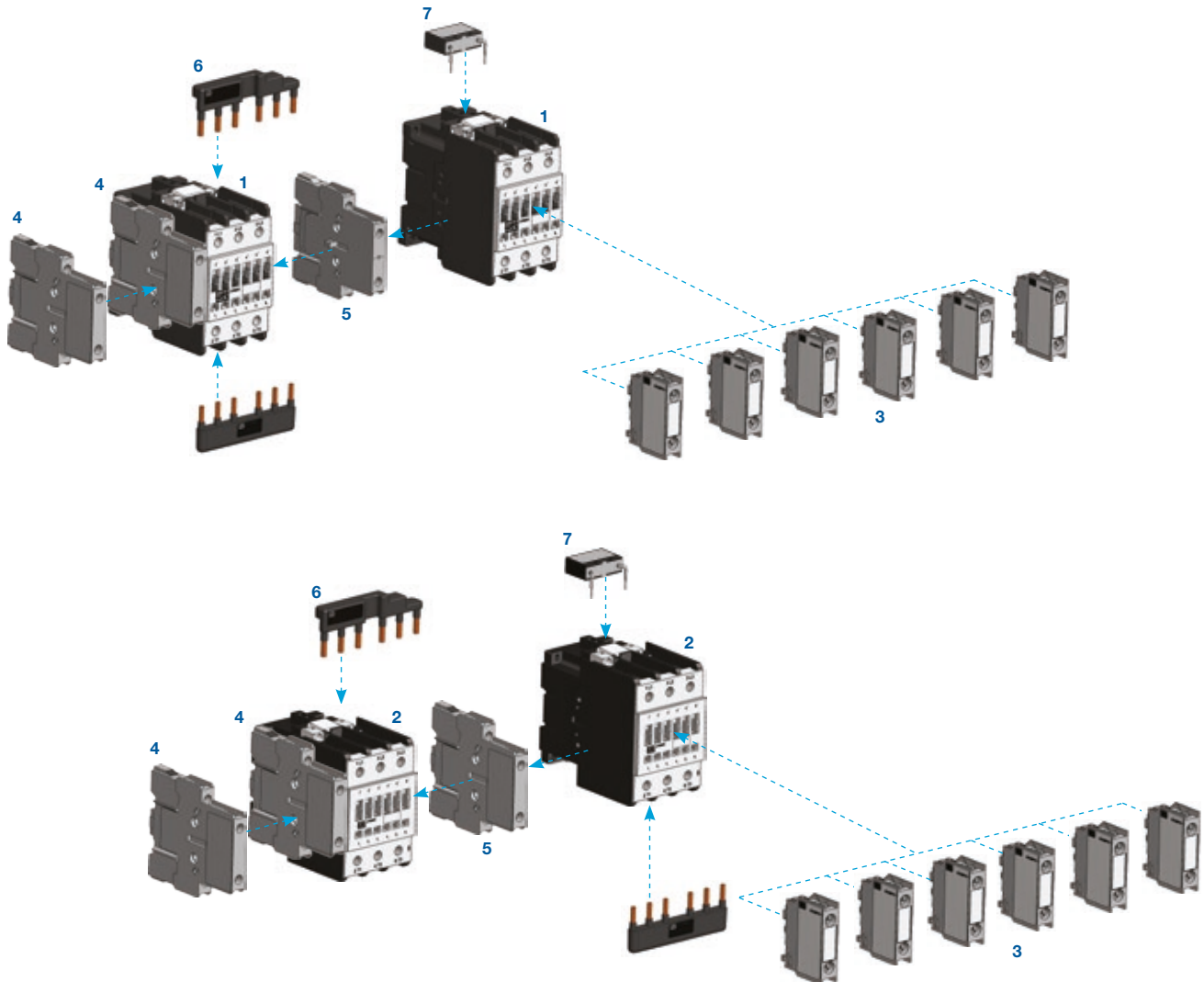

- 1 - Contactors CWM50...80
- 2 - Contactors CWM95/105
- 3 - Front mounting auxiliary contact block BCXMF
- 4 - Side mounting auxiliary contact block BCXML
- 5 - Mechanical interlock block BLIM
- 6 - Easy connection busbar
- 7 - Surge suppressor blocks BAM

CWM Contactors from 112 up to 300 A (AC-3) - Accessories Overview

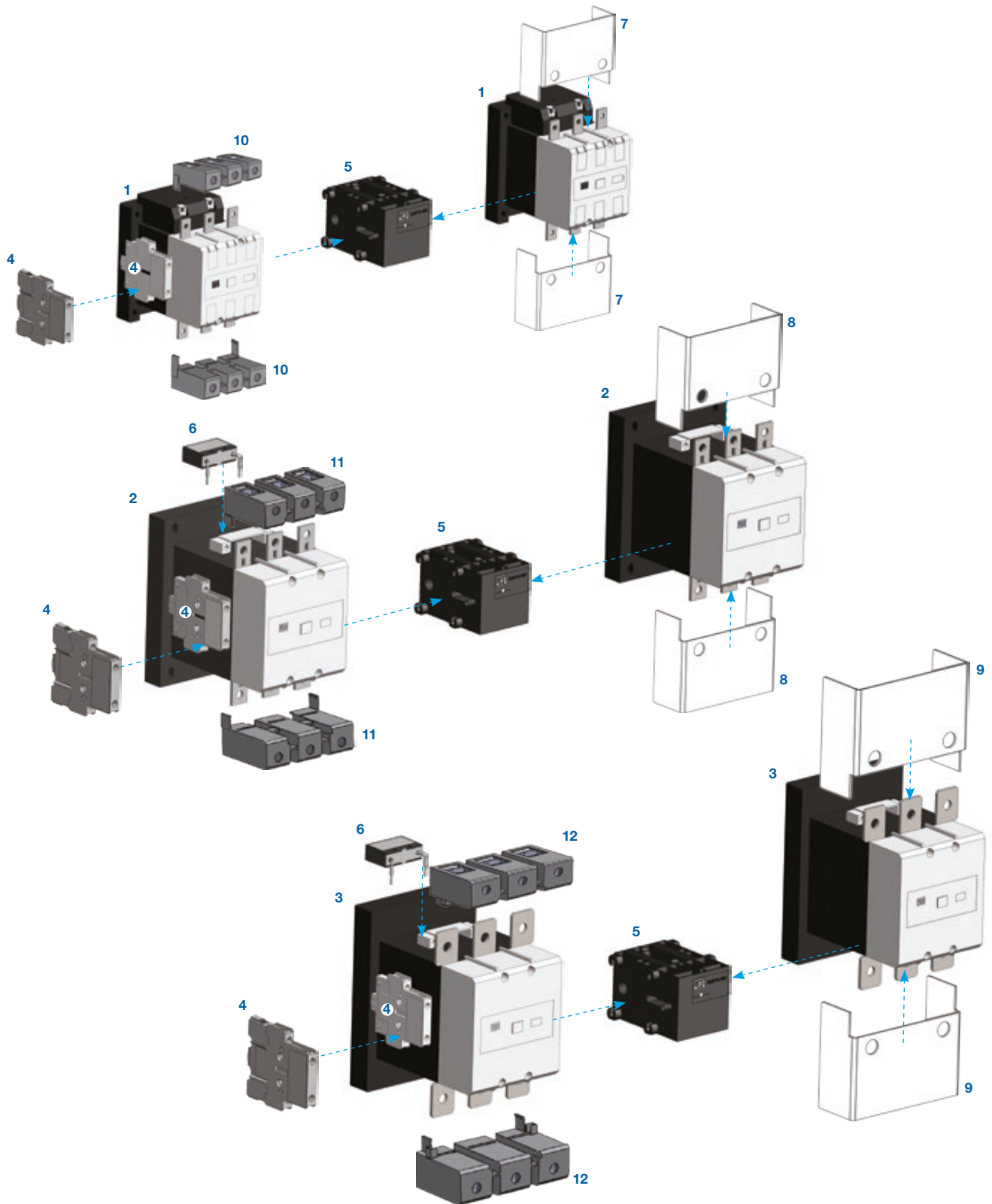

- 1 - Contactors CWM112/150
- 2 - Contactors CWM180
- 3 - Contactors CWM250/300
- 4 - Side mounting auxiliary contact block BCXML
- 5 - Mechanical interlock BLIM112-300
- 6 - Surge suppressor block BAMV

- 7 - Terminal cover BMP CWM150
- 8 - Terminal cover BMP CWM180
- 9 - Terminal cover BMP CWM300
- 10 - TB150 terminal block for CWM112-150
- 11 - TB180 terminal block for CWM180
- 12 - TB300 terminal block for CWM250-300

CWM Contactors from 400 up to 800 A (AC-3) - Accessories Overview

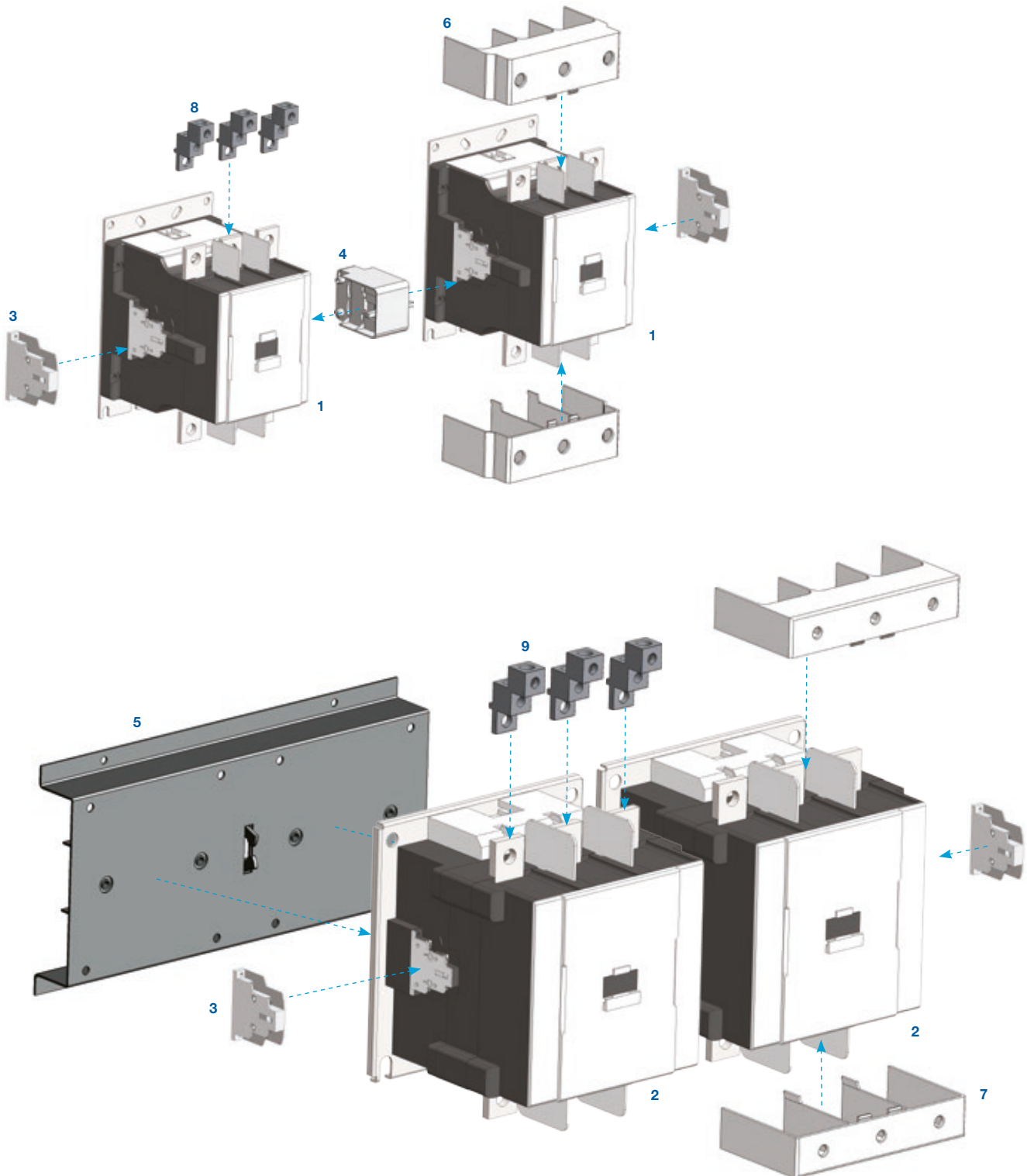

- 1 - Contactor CWM400
- 2 - Contactors CWM500...800
- 3 - Auxiliary contacts block BCXMRL CWM800
- 4 - Mechanical interlock BLIM CWM400
- 5 - Mechanical interlock BLIM CWM800
- 6 - Terminal cover BMP CWM400
- 7 - Terminal cover BMP CWM800
- 8 - Lugs BMJ CWM400
- 9 - Lugs BMJ CWM800

CWM Contactors - Selection Table

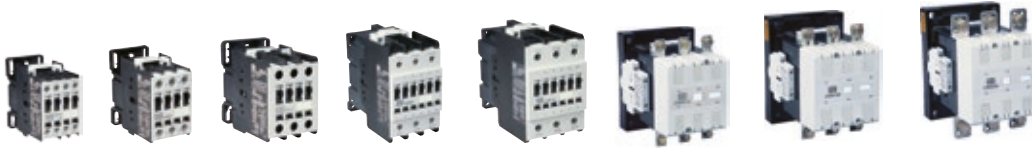

Three-Pole Contactors from 9 up to 250 A (AC-3) - AC Coil³⁾

Rated operational current I_b AC-3 ($U_e \leq 440$ V)	Conv. thermal current $I_{th} = I_b$ AC-1	Max. rated operational power of three-phase motors 50/60 Hz ¹⁾						Auxiliary contacts per contactor		Auxiliary contact blocks separately delivered		Reference code to complete with voltage code	Weight kg
		220 V 230 V	380 V	400 V 415 V	440 V	500 V	660 V 690 V	NO	NC	BCXMF10 NO	BCXMF01 NC		
9	25	2.2 / 3	4 / 5	4 / 5	4.5 / 6	4.5 / 6	5.5 / 7.5	1	0	Built-in	-	CWM9-10-30♦	0.360
								0	1	-	Built-in	CWM9-01-30♦	
								1	1	Built-in	1	cWM9-11-30♦	
								2	2	1	2	CWM9-22-30♦	
12	25	3 / 4	5.5 / 7.5	5.5 / 7.5	5.5 / 7.5	5.5 / 7.5	7.5 / 10	1	0	Built-in	-	CWM12-10-30♦	0.360
								0	1	-	Built-in	CWM12-01-30♦	
								1	1	Built-in	1	CWM12-11-30♦	
								2	2	1	2	CWM12-22-30♦	
18	32	4.5 / 6	7.5 / 10	7.5 / 10	9.2 / 12.5	9.2 / 12.5	11 / 15	1	0	Built-in	-	CWM18-10-30♦	0.360
								0	1	-	Built-in	CWM18-01-30♦	
								1	1	Built-in	1	CWM18-11-30♦	
								2	2	1	2	CWM18-22-30♦	
25	45	5.5 / 7.5	11 / 15	11 / 15	11 / 15	11 / 15	11 / 15	0	0	-	-	CWM25-00-30♦	0.390
								1	0	1	-	CWM25-10-30♦	
								0	1	-	1	CWM25-01-30♦	
								1	1	1	1	CWM25-11-30♦	
								2	2	2	2	CWM25-55-30♦	
32	60	9.2 / 12.5	15 / 20	15 / 20	15 / 20	15 / 20	18.5 / 25	0	0	-	-	CWM32-00-30♦	0.620
								1	0	1	-	CWM32-10-30♦	
								0	1	-	1	CWM32-01-30♦	
								1	1	1	1	CWM32-11-30♦	
								2	2	2	2	CWM32-22-30♦	
40	60	11 / 15	18.5 / 25	18.5 / 25	22 / 30	22 / 30	22 / 30	0	0	-	-	CWM40-00-30♦	0.650
								1	1	1	1	CWM40-11-30♦	
								2	2	2	2	CWM40-22-30♦	
50	90	15 / 20	22 / 30	22 / 30	30 / 40	30 / 40	30 / 40	0	0	-	-	CWM50-00-30♦	1.205
								1	1	1	1	CWM50-11-30♦	
								2	2	2	2	CWM50-22-30♦	
65	110	18.5 / 25	30 / 40	30 / 40	37 / 50	37 / 50	37 / 50	0	0	-	-	CWM65-00-30♦	1.215
								1	1	1	1	CWM65-11-30♦	
								2	2	2	2	CWM65-22-30♦	
80	110	22 / 30	37 / 50	45 / 60	45 / 60	45 / 60	45 / 60	0	0	-	-	CWM80-00-30♦	1.220
								1	1	1	1	CWM80-11-30♦	
								2	2	2	2	CWM80-22-30♦	
95	140	22 / 30	45 / 60	55 / 75	55 / 75	55 / 75	55 / 75	0	0	-	-	CWM95-00-30♦	1.525
								1	1	1	1	CWM95-11-30♦	
								2	2	2	2	CWM95-22-30♦	
105	140	30 / 40	55 / 75	55 / 75	55 / 75	55 / 75	55 / 75	0	0	-	-	CWM105-00-30♦	1.505
								1	1	1	1	CWM105-11-30♦	
								2	2	2	2	CWM105-22-30♦	
112	180	30 / 40	55 / 75	55 / 75	55 / 75	55 / 75	75 / 100	2	2	-	-	CWM112-22-30♦	3.1
180	225	55 / 75	90 / 125	90 / 125	110 / 150	110 / 150	110 / 150	2	2	-	-	CWM180-22-30♦	51.0
250	350	75 / 100	132 / 175	132 / 175	150 / 200	160 / 220	160 / 220	2	2	-	-	CWM250-22-30♦	6.66

Replace “♦” with the Appropriate Coil Voltage Code²⁾

AC coil - 50/60 Hz												
Coil voltage codes	D02	D07	D13	D23	D24	D25	D33	D34	D35	D36	D39	
V ac - 50/60 Hz	24	48	110	220	230	240	380	400	415	440	480	

Notes: 1) For 50/60 Hz three-phase, 4 poles WEG standard motors. These values are only for reference and may change on the number of poles and motor design.

2) Other voltages available.

3) For selection of accessories, check page 13.

CWM Contactors - Selection Table



Three-Pole Contactors from 40 up to 105 A (AC-3) - DC Coil⁴⁾⁵⁾

Rated operational current I_e AC-3 ($U_e \leq 440$ V)	Conv. thermal current $I_{th} = I_e$ AC-1	Max. rated operational power of three-phase motors 50/60 Hz ¹⁾						Auxiliary contacts per contactor		Auxiliary contact blocks separately delivered		Reference code to complete with voltage code	Weight kg
		220 V 230 V	380 V	400 V 415 V	440 V	500 V	660 V 690 V	NO	NC	BCXMF10	BCXMF01		
40	60	11 / 15	18.5 / 25	18.5 / 25	22 / 30	22 / 30	22 / 30	0	0	-	-	CWM40-00-30♦	0.640
								1	1	1	1	CWM40-11-30♦	
								2	2	2	2	CWM40-22-30♦	
50	90	15 / 20	22 / 30	22 / 30	30 / 40	30 / 40	30 / 40	0	0	-	-	CWM50-00-30♦	1.463
								1	1	1	1	CWM50-11-30♦	
								2	2	2	2	CWM50-22-30♦	
65	110	18.5 / 25	30 / 40	30 / 40	37 / 50	37 / 50	37 / 50	0	0	-	-	CWM65-00-30♦	1.463
								1	1	1	1	CWM65-11-30♦	
								2	2	2	2	CWM65-22-30♦	
80	110	22 / 30	37 / 50	45 / 60	45 / 60	45 / 60	45 / 60	0	0	-	-	CWM80-00-30♦	1.463
								1	1	1	1	CWM80-11-30♦	
								2	2	2	2	CWM80-22-30♦	
95	140	22 / 30	45 / 60	55 / 75	55 / 75	55 / 75	55 / 75	0	0	-	-	CWM95-00-30♦	1.463
								1	1	1	1	CWM95-11-30♦	
								2	2	2	2	CWM95-22-30♦	
105	140	30 / 40	55 / 75	55 / 75	55 / 75	55 / 75	55 / 75	0	0	-	-	CWM105-00-30♦	1.463
								1	1	1	1	CWM105-11-30♦	
								2	2	2	2	CWM105-22-30♦	

Replace “♦” with the Appropriate Coil Voltage Code²⁾³⁾



Coil voltage codes (CWM40...105)	C34	C37	C40	C44
V dc	24-28	42-50	110-130	208-240

Notes: 1) For 50/60 Hz three-phase, 4 poles WEG standard motors. These values are only for reference and may change on the number of poles and motor design.
 2) Other voltages available.
 3) Contactors CWM40-105 with DC coils do not need surge suppressor blocks. The surge suppressor is already integrated in this coil.
 4) For selection of accessories, check page 13.
 5) For lower currents than 40 A (AC-3) use the new line CWB9...38.

CWM Contactors - Selection Table



Three-Pole Contactors from 112 up to 300 A (AC-3) - Coil with Electronic Module AC/DC



Rated operational current I_c AC-3 ($U_c \leq 440$ V)	Conv. thermal current $I_{th} = I_c$ AC-1	Max. rated operational power of three-phase motors 50/60 Hz ¹⁾						Auxiliary contacts per contactor (BCXML)		Reference code to complete with voltage code	Weight kg
		220 V 230 V	380 V	400 V 415 V	440 V	500 V	690 V				
A	A	kW / HP	kW / HP	kW / HP	kW / HP	kW / HP	kW / HP	NO	NC		
112	180	30 / 40	55 / 75	55 / 75	55 / 75	55 / 75	75 / 100	2	2	CWM112-22-30◆	3.12
150	225	45 / 60	75 / 100	75 / 100	90 / 125	90 / 125	110 / 150	2	2	CWM150-22-30◆	3.20
180	225	50 / 75	90 / 125	90 / 125	110 / 150	110 / 150	110 / 150	2	2	CWM180-22-30◆	5.01
250	350	75 / 100	132 / 175	132 / 175	150 / 200	160 / 220	160 / 200	2	2	CWM250-22-30◆	6.86
300	410	90 / 125	150 / 200	160 / 220	185 / 250	200 / 270	200 / 270	2	2	CWM300-22-30◆	6.73

Replace “◆” with the Appropriate Coil Voltage Code²⁾

Coil voltage codes	E02	E06	E07	E10	E13	E16	E21
50/60 Hz / DC ³⁾	24-28 V	42-50 V	60-72 V	110-130 V	208-250 V	360-415 V	430-500 V



Three-Pole Contactors from 400 up to 800 A (AC-3) - Coil with Electronic Module AC/DC

Rated operational current I_c AC-3 ($U_c \leq 440$ V)	Conv. thermal current $I_{th} = I_c$ AC-1	Max. rated operational power of three-phase motors 50/60 Hz ¹⁾						Auxiliary contacts per contactor (BCXML)		Reference code to complete with voltage code	Weight kg
		220 V 230 V	380 V	400 V 415 V	440 V	500 V	690 V				
A	A	kW / HP	kW / HP	kW / HP	kW / HP	kW / HP	kW / HP	NO	NC		
400	450	125 / 150	220 / 300	220 / 300	220 / 300	220 / 300	250 / 330	2	2	CWM400-22-30◆	9.2
500	580	150 / 200	265 / 355	265 / 355	265 / 355	265 / 355	300 / 400	2	2	CWM500-22-30◆	22.4
630	660	190 / 250	330 / 450	330 / 450	330 / 450	330 / 450	330 / 450	2	2	CWM630-22-30◆	23.2
800	900	220 / 300	440 / 600	440 / 600	440 / 600	500 / 700	500 / 700	2	2	CWM800-22-30◆	23.3

Replace “◆” with the Appropriate Coil Voltage Code²⁾

Coil voltage codes (CWM400)	E36	D80	D81	D82
50/60 Hz / DC ³⁾	100-240 V ac / 100-220 V dc	-	-	-
50/60 Hz ³⁾	-	265-347 V	380-450 V	440-575 V

Coil voltage codes (CWM500/630/800)	E35	E39	D80	D81	D82
50/60 Hz / DC ³⁾	100-127 V ac / 100-110 V dc	200-240 V ac / 200-220 V dc	-	-	-
50/60 Hz ³⁾	-	-	265-347 V	380-450 V	440-575 V

Notes: 1) For 50/60 Hz three-phase, 4 poles WEG standard motors. These values are only for reference and may change on the number of poles and motor design.
 2) Other voltages available.
 3) Surge suppressor is already integrated.

CWM Contactors - Selection Table



Four-Pole Contactors from 25 to 32 A (AC-1)

$I_e = I_{th}$ $(U_e \leq 690 \text{ V})$ $\theta \leq 55 \text{ }^\circ\text{C}$ AC-1 A	Number of poles		Reference code to complete with voltage code	Weight kg
	$\begin{array}{c} \cdot 3 \\ \\ \diagdown \\ \cdot 4 \\ \text{NO} \end{array}$	$\begin{array}{c} \cdot 1 \\ \\ \diagup \\ \cdot 2 \\ \text{NC} \end{array}$		
25	2	2	CWM9-00-22♦	0.360
	4	-	CWM9-00-40♦	
25	2	2	CWM12-00-22♦	0.360
	4	-	CWM12-00-40♦	
32	2	2	CWM18-00-22♦	0.360
	4	-	CWM18-00-40♦	

Replace “♦” with the Appropriate Coil Voltage Code¹⁾

AC coil - 50/60 Hz											
Applicable for CWC07...CWC025 models											
Coil voltage codes	D02	D07	D13	D23	D24	D25	D33	D34	D35	D36	D39
V ac - 50/60 Hz	24	48	110	220	230	240	380	400	415	440	480

Four-Pole Contactors from 420 up to 800 A AC-1 - Coil with Electronic Module AC/DC

Conv. thermal current I_m (55°C) A	AC-1 current A	AC-1 power				Auxiliary contacts per contactor (BCXML)		Reference code to complete with voltage code	Weight kg
		220 V 240 V kW	380 V 400 V kW	500 V 550 V kW	690 V kW	$\begin{array}{c} \cdot 3 \\ \\ \diagdown \\ \cdot 4 \\ \text{NO} \end{array}$	$\begin{array}{c} \cdot 1 \\ \\ \diagup \\ \cdot 2 \\ \text{NC} \end{array}$		
500	420	160	300	375	470	2	2	CWM400-22-40♦	9.9
630	630	245	450	560	710	2	2	CWM500-22-40♦	26.3
750	660	255	470	590	740	2	2	CWM630-22-40♦	26.3
900	800	310	570	710	900	2	2	CWM800-22-40♦	26.3

Replace “♦” with the Appropriate Coil Voltage Code²⁾



Coil voltage codes (CWM400)	E36	D80	D81	D82
50/60 Hz / DC ³⁾	100-240 V ac / 100-220 V dc	-	-	-
50/60 Hz ³⁾	-	265-347 V	380-450 V	440-575 V

Coil voltage codes (CWM500/630/800)	E35	E39	D80	D81	D82
50/60 Hz / DC ³⁾	100-127 V ac / 100-110 V dc	200-240 V ac / 200-220 V dc	-	-	-
50/60 Hz ³⁾	-	-	265-347 V	380-450 V	440-575 V





CWM Contactors - Accessories

Auxiliary Contact Blocks

- Terminal markings to EN 50 005 and EN 50 012
- Positive driven contacts in accordance with IEC 60947-4-1 resp. IEC 60947-5-1

Illustrative picture	For use with	Max. number of contacts/ contactor	Auxiliary contacts		Reference code	Weight kg
			NO	NC		
	CWM9...105	4 / CWM9...25	1	0	BCXMF10	0.015
			0	1	BCXMF01	
			1 ¹⁾	0	BCXMF10	
			0	1 ²⁾	BCXMF01	
			1 ⁶⁾	0	BCXMF10AU	
			0	1 ⁶⁾	BCXMF01AU	
	CWM9...300	8 / CWM112...300	2	0	BCXML20	0.050
			1	1	BCXML11	
			2	0	BCXMRL20 ³⁾	
			1	1	BCXMRL11 ³⁾	
	CWM 400...800	8 / CWM400...800	1	1	BCXML11 CWM800	0.045
BCXMRL11 CWM800 ³⁾						

Mechanical Interlock for Contactors⁵⁾

Illustrative picture	For use with	Reference code	Weight kg
	CWM9...CWM105 - 3 or 4-pole	BLIM9-105	0.050
		BLIM.02 ⁴⁾	
	CWM112...CWM300 - 3-pole	BLIM112-300	0.150
	CWM400 - 3 or 4-pole	BLIM CWM400	0.100
	CWM500...800 - 3-pole	BLIM CWM800	15.0
	CWM500...800 - 4-pole	BLIM CWM800-4P	16.0

- Notes: 1) Early-make contact.
 2) Late-break contact.
 3) For combination of more than 2 side-mounted auxiliary contacts.
 4) This accessory allows mechanical and electrical interlock.
 5) Can only be used with 2 contactors of the same frame.
 6) Auxiliary contact block for low current levels (1 mA / 17 V).

CWM Contactors - Accessories

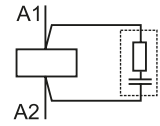
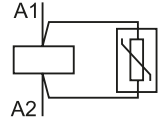

Surge Suppressors

- Connect directly to coil terminals A1 - A2

Illustrative picture	For use with	Voltage	Circuit diagram	Reference code	Weight kg	
	CWM9...40	24 - 48 V 50/60 Hz		BAMRC4 D53	0.014	
		50 - 127 V 50/60 Hz		BAMRC5 D55		
		130 - 250 V 50/60 Hz		BAMRC6 D63		
	CWM50...105	24 - 48 V 50/60 Hz		BAMRC7 D53		
		50 - 127 V 50/60 Hz		BAMRC8 D55		
		130 - 250 V 50/60 Hz		BAMRC9 D63		
	CWM112...250	24 - 48 V 50/60 Hz		BAMRC13 D53		
		50 - 250 V 50/60 Hz		BAMRC14 D56		
	CWM9...105	270 - 380 V 50/60 Hz				BAMV1 D68
		400 - 510 V 50/60 Hz				BAMV2 D73
	CWM112...250	270 - 380 V 50/60 Hz				BAMV3 D68
		400 - 510 V 50/60 Hz				BAMV4 D73

Terminal Cover

- Protection against touching in accordance with relating installation rules

Illustrative picture	For use with	Description	Reference code	Weight kg
	CWM112/150	1 kit with 2 parts ¹⁾	BMP CWM150	0.10
	CWM180		BMP CWM180	0.15
	CWM250/300		BMP CWM300	0.20
	CWM112/150	1 kit with 1 part ¹⁾	BMP1 CWM150	0.05
	CWM180		BMP1 CWM180	0.08
	CWM250/300		BMP1 CWM300	0.10
	CWM400 (3-pole)	1 kit with 2 parts ¹⁾	BMP CWM400	0.12
	CWM500...800 (3-pole)		BMP CWM800	0.28
	CWM400 (4-pole)		BMP CWM400-4P	0.16
	CWM500...800 (4-pole)		BMP CWM800-4P	0.37

Terminal Blocks²⁾

Illustrative picture	For use with	Flexible cable	Tightening torque	Description	Reference code	Weight kg
	CWM112/150	25...70 mm ² 3...2/0 AWG	14 N.m	1 unit (3-pole)	TB150	0.29
	CWM180	50...120 mm ² 1/0...250 kcmil AWG	14 N.m		TB180	0.35
	CWM250/300	50...150 mm ² 1/0...300 kcmil AWG	20 N.m		TB300	0.45

Lug Terminals

Illustrative picture	For use with	Description	Reference code	Weight kg
	CWM400	1 kit with 3 pieces	BMJ CWM400	0.495
	CWM500...800	1 kit with 3 pieces	BMJ CWM400	1.0

Notes: 1) Every part is a 3-phase protector.

2) For IP20 protection degree on front.

CWM Contactors - Accessories

Reversing Wiring Kits¹⁾

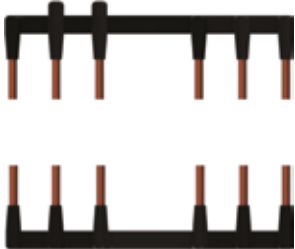
Illustrative picture	Rated operational current Ie AC - 3 (U _e ≤ 440 V) A	Maximum rated operational power of three-phase motors 50/60 Hz			Contactors	Reference code	Weight kg
		220-230 V	400-415 V	660-690 V			
		kW / HP	kW / HP	kW / HP	K1 = K2		
	9	2.2 / 3	4 / 5	5.5 / 7.5	CWM9	EC-R-7.5	0.033
	12	3 / 4	5.5 / 7.5	7.5 / 10	CWM12		
	18	4.5 / 6	7.5 / 10	11 / 15	CWM18		
	25	5.5 / 7.5	11 / 15	11 / 15	CWM25	EC-RC-11	0.5
	32	9.2 / 12.5	15 / 20	18.5 / 25	CWM32	EC-RC-18.5	
	40	11 / 15	18.5 / 25	22 / 30	CWM40		
	50	15 / 20	22 / 30	30 / 40	CWM50	EC-RC-37	
	65	18.5 / 25	30 / 40	37 / 50	CWM65		
	80	22 / 30	45 / 60	45 / 60	CWM80		

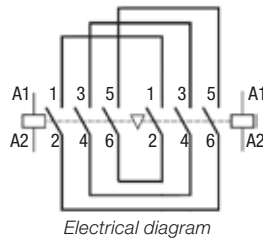
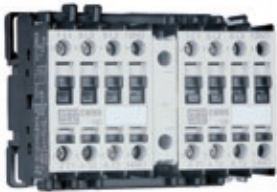

Star-Delta Wiring Kits¹⁾

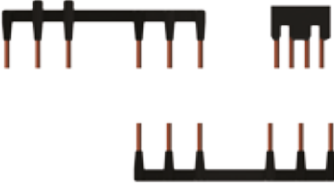
Illustrative picture	Rated operational current Ie AC - 3 (U _e ≤ 440 V) A	Maximum rated operational power of three-phase motors 50/60 Hz			Contactors		Reference code	Weight kg
		220-230 V	400-415 V	660-690 V	K1 = K2	K3		
		kW / HP	kW / HP	kW / HP				
	25	5.5 / 7.5	11 / 15	18.5 / 25	CWM18	CWM9	EC-SD-15	0.051
	32	7.5 / 10	15 / 20	18.5 / 25	CWM18	CWM12		
	40	7.5 / 10	18.5 / 25	22 / 30	CWM25	CWM18	EC-SD-22	0.5
	50	11 / 15	22 / 30	22 / 30	CWM25	CWM18		
	54	15 / 20	22 / 30	30 / 40	CWM32	CWM18	EC-SD-25	
	60	15 / 20	30 / 40	37 / 50	CWM40	CWM25	EC-SD-30	
	80	18.5 / 25	37 / 50	45 / 60	CWM50	CWM25	EC-SD-37	
	85	22 / 30	45 / 60	55 / 75	CWM50	CWM32	EC-SD-55	
	105	30 / 40	55 / 75	55 / 75	CWM65	CWM40		
	138	37 / 50	75 / 100	75 / 100	CWM80	CWM50	EC-SD-75	
	140	37 / 50	75 / 100	90 / 125	CWM95	CWM50	EC-SD-90	
	175	45 / 60	90 / 125	110 / 150	CWM105	CWM65		

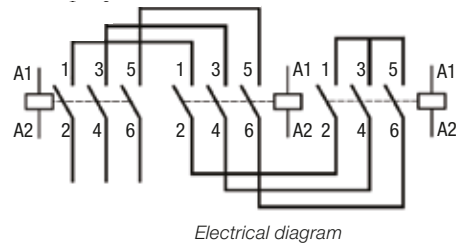
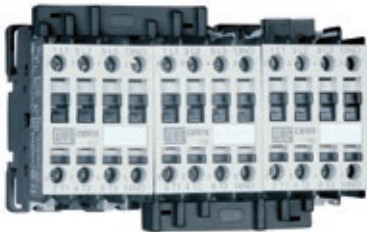

3-Pole Jumper (k3) for Star-Delta Starters

Illustrative picture	For use with	Description	Reference code	Weight kg
	CWM9...18	3-pole jumper to connect in parallel L1-L2-L3 k3 contactor terminals in a star-delta starter	SBCM9-18	0.006
	CWM25		SBCM25	0.006
	CWM32/40		SBCM32-40	0.015
	CWM50/65		SBCM50-65	0.031

Note: 1) Contactors and mechanical interlock are sold separately.

CWM Contactors - Reversing Starters

Individual Components for Reversing Starters

Maximum rated operational power of three-phase motors 50/60 Hz				Individual components for reversing starters					
220-230 V kW / HP	400-415 V kW / HP	500 V kW / HP	660-690 V kW / HP	Contactor K1	Contactor K2	Spare auxiliary contacts		Mechanical interlock	Wiring kit
				Type	Type	K1	K2		
2.2 / 3	4 / 5	4.5 / 6	5.5 / 7.5	CWM9-11	CWM9-11	-	-	BLIM9-105	EC-SD...
3 / 4	5.5 / 7.5	5.5 / 7.5	7.5 / 10	CWM12-11	CWM12-11	-	-		
4.5 / 6	7.5 / 10	9.2 / 12.5	11 / 15	CWM18-11	CWM18-11	-	-		
5.5 / 7.5	11 / 15	11 / 15	11 / 15	CWM25-11	CWM25-11	-	-		
9.2 / 12.5	15 / 20	15 / 20	18.5 / 25	CWM32-11	CWM32-11	-	-		
11 / 15	18.5 / 25	22 / 30	22 / 30	CWM40-11	CWM40-11	-	-		
15 / 20	22 / 30	30 / 40	30 / 40	CWM50-11	CWM50-11	-	-		
18.5 / 25	30 / 40	37 / 50	37 / 50	CWM65-11	CWM65-11	-	-		
22 / 30	45 / 60	45 / 60	45 / 60	CWM80-11	CWM80-11	-	-		
22 / 30	55 / 75	55 / 75	55 / 75	CWM95-11	CWM95-11	-	-		
30 / 40	55 / 75	55 / 75	55 / 75	CWM105-11	CWM105-11	-	-		
30 / 40	55 / 75	55 / 75	75 / 100	CWM112-22	CWM112-22	1NO/1NC	1NO/1NC	BLIM112-300	-
45 / 60	75 / 100	90 / 125	110 / 150	CWM150-22	CWM150-22	1NO/1NC	1NO/1NC		
55 / 75	90 / 125	110 / 150	110 / 150	CWM180-22	CWM180-22	1NO/1NC	1NO/1NC		
75 / 100	132 / 175	160 / 220	160 / 220	CWM250-22	CWM250-22	1NO/1NC	1NO/1NC		
90 / 125	160 / 220	200 / 270	200 / 270	CWM300-22	CWM300-22	1NO/1NC	1NO/1NC		

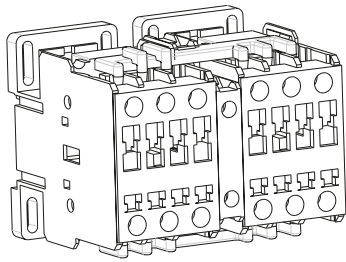

Reversing starters

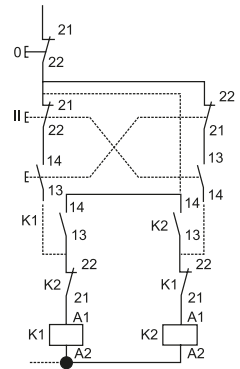
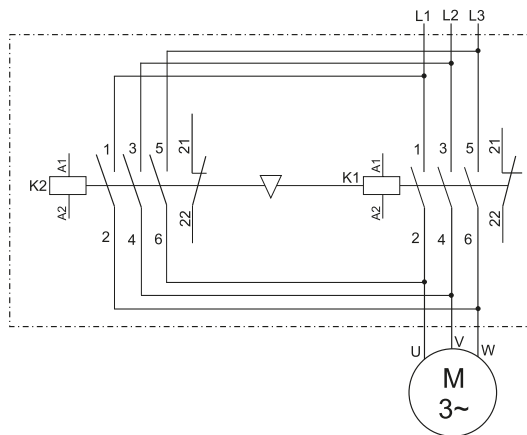

CWM Contactors - Star-Delta Starters

Individual Components for Star-Delta Starters

Maximum rated operational power of three-phase motors 50/60 Hz				Individual components for star-delta starters							
220-230 V kW / HP	400-415 V kW / HP	500 V kW / HP	660-690 V kW / HP	Main contactor K1	Delta contactor K2	Star contactor K3	Timer	Spare auxiliary contacts			Wiring kit
				Type	Type	Type		K1	K2	K3	
5.5 / 7.5	11 / 15	15 / 20	18.5 / 25	CWM18-10 + BCXMF10	CWM18-11	CWM9-11	RTW-E1...	-	-	-	EC-SD...
7.5 / 10	15 / 20	15 / 20	18.5 / 25	CWM18-10 + BCXMF10	CWM18-11	CWM12-11		-	-	-	
7.5 / 10	18.5 / 25	22 / 30	22 / 30	CWM25-00 + 2 x BCXMF10	CWM25-11	CWM18-11		-	-	-	
11 / 15	22 / 30	22 / 30	22 / 30	CWM25-00 + 2 x BCXMF10	CWM25-11	CWM18-11		-	-	-	
15 / 20	30 / 40	37 / 50	37 / 50	CWM40-00 + 2 x BCXMF10	CWM40-11	CWM25-11		-	-	-	
18.5 / 25	37 / 50	37 / 50	45 / 60	CWM50-00 + 2 x BCXMF10	CWM50-11	CWM25-11		-	-	-	
22 / 30	45 / 60	45 / 60	55 / 75	CWM50-00 + 2 x BCXMF10	CWM50-11	CWM32-11		-	-	-	
30 / 40	55 / 75	55 / 75	55 / 75	CWM65-00 + 2 x BCXMF10	CWM65-11	CWM40-11		-	-	-	
37 / 50	75 / 100	75 / 100	90 / 125	CWM95-00 + 2 x BCXMF10	CWM95-11	CWM50-11		-	-	-	
45 / 60	90 / 125	110 / 150	110 / 150	CWM105-00 + 2 x BCXMF10	CWM105-11	CWM65-11		-	-	-	
55 / 75	110 / 150	110 / 150	132 / 175	CWM150-22	CWM150-22	CWM65-11		2NC	1NO/NC	-	
75 / 100	132 / 175	132 / 175	132 / 175	CWM180-22	CWM180-22	CWM80-11		2NC	1NO/NC	-	
90 / 125	160 / 220	160 / 220	200 / 300	CWM250-22	CWM250-22	CWM105-11		2NC	1NO/NC	-	
110 / 150	200 / 270	250 / 330	-	CWM300-22	CWM300-22	CWM150-22		2NC	1NO/NC	1NO/NC	

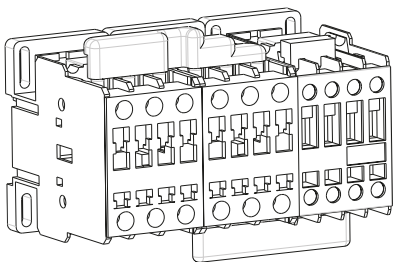

Star-Delta Starters

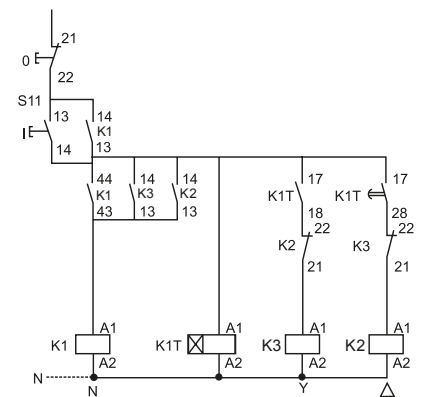
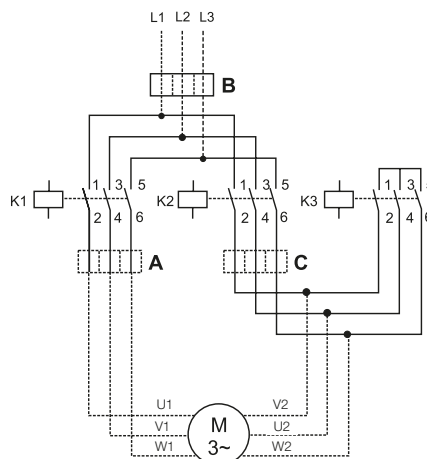

- A: $0.58 \times I_r$, motor protection at star and delta position
- B: $1 \times I_r$, only partial motor protection at star position
- C: $0.58 \times I_r$, motor not protected at star position

CWM Contactors - Spare Parts

Individual Spare Coils

Illustrative picture	Description	For use with	Reference code to complete with voltage code	Weight kg
	AC coil	CWM9...25	BCA4-25♦	0.065
		CWM32...40	BCA4-40♦	0.110
		CWM50...105	BCA-105♦	0.140
		CWM112	BCA-112♦	0.235
		CWM180	BCA-180♦	0.400
		CWM250	BCA-250♦	0.675
	DC coil	CWM40	BECC4-40♦	0.180
		CWM50...105	BECC-105♦	0.220
	Dual-voltage coils AC/DC (contactors with electronic module)	CWM112...150	BCE-150♦	1.0
		CWM180	BCE-215♦	
		CWM250...300	BCE-300♦	
		CWM400	BCE400♦ ¹⁾	
CWM500...800	BCE800♦ ¹⁾			

Electronic Module

Illustrative picture	Control type	For use with	Reference code	Weight kg
	AC/DC	CWM112...300	ME-300♦ ³⁾	0.140

Replace “♦” with the Appropriate Coil Voltage Code²⁾

Contactors CWM9...300

Coil voltage codes (CWM9...250)	D02	D07	D13	D24	D25	D34	D35
50/60 Hz	24 V	48 V	110 V	230 V	240 V	400 V	415 V

Coil voltage codes (CWM40...105)	C34	C37	C40	C44
V dc	24-28 V	42-50 V	110-130 V	208-240 V

Coil voltage codes (CWM112...300)	E02	E06	E07	E10	E13	E16	E21
50/60 Hz / DC ⁴⁾	24-28 V	42-50 V	60-72 V	110-130 V	208-250 V	360-415 V	430-500 V

Contactors CWM400...800

Coil voltage codes (CWM400)	E36	D80	D81	D82
50/60 Hz / DC ⁴⁾	100-240 V ac / 100-220 V dc	-	-	-
50/60 Hz ⁴⁾	-	265-347 V	380-450 V	440-575 V

Coil voltage codes (CWM500...800)	E35	E39	D80	D81	D82
50/60 Hz / DC ⁴⁾	100-127 V ac / 100-110 V dc	200-240 V ac / 200-220 V dc	-	-	-
50/60 Hz ⁴⁾	-	-	265-347 V	380-450 V	440-575 V

Notes: 1) Integrated coil with electronic module.

2) Other voltages on request.

3) The coil voltage code must be the same of BCE coil voltage code selected.

4) Surge suppressor is already integrated.

CWM Contactors - Technical Data

General Data

Reference code	CWM9	CWM12	CWM18	CWM25	CWM32	CWM40	CWM50	CWM65	CWM80	CWM95	CWM105	CWM112	CWM150	CWM180	CWM250	CWM300
Standards	IEC 60947 / UL 508															
Rated insulation voltage U_i IEC 60947 UL / CSA	1,000 V 600 V															
Rated impulse withstand voltage U_{imp}	6 kV								8 kV							
Rated operational frequency	25 - 400 Hz															
Degree of protection	Protection against direct contact from the front when operated by a perpendicular test finger (IEC 536)															
Main circuits	IP20				IP10								IP00			
Control circuits and auxiliary contacts	IP20															
Ambient temperature	-25 °C to +55 °C															
Operating temperature	-55 °C to +80 °C															
Storage temperature	-55 °C to +80 °C															
Altitude	Up to 3,000 m															
Normal values	3,000 to 4,000 m															
90% I_e / 80% U_e	4,000 to 5,000 m															
80% I_e / 75% U_e																
Overvoltage category / Pollution degree	III / 3															
Climatic proofing	Acc. IEC 60680-2															
Pole numbers of main circuits	3															
Rated operation voltage U_e	690 V								1,000 V							
Mechanical lifespan	Ops x 10 ⁶ 10															
Electrical lifespan (AC - 3)	Ops x 10 ⁶ 1.5				1.2				1.1				1.0			
Mounting	Screw or 35 mm DIN Rail												Screw			

Control Circuit

Reference code	CWM9	CWM12	CWM18	CWM25	CWM32	CWM40	CWM50	CWM65	CWM80	CWM95	CWM105	CWM112	CWM150	CWM180	CWM250	CWM300				
Rated insulation voltage U_i	IEC 1,000 V																			
	UL, CSA 600 V																			
Rated voltages (standard coil)	Us 50/60 Hz 12...660 V								12...550 V		-		24...690		-					
Rated voltages (electronic module)	Us 50/60 Hz -								24...500 V											
Rated voltages	Us dc - 24...240 V 24...500 V																			
Operation time ¹⁾	Closing/Opening (AC) ms		8...20 / 6...13				10...19 / 5...25				15...30 / 9...15				60...70 / 13...17					
	Closing/Opening (DC) ms		- 50...60 / 55...60 60...70 / 13...17 60...70 / 15...25																	
Power consumption of the AC coil 50/60 Hz ¹⁾																				
Pick-up	(VA)		69.5				98				255				590		759		1,104	
	cos φ		0.85				0.69				0.32				0.43		0.14		0.16	
Sealing	(VA)		4...7.2				6.6...12.3				13.1...19.1				28...41		37...52		70...105	
	cos φ		0.28				0.34				0.54				0.31		0.39		0.36	
Coil operation limits 50/60 Hz ¹⁾																				
0.85...1.1 x U_s 0.65...1.1 x U_s																				
Bifrequency coils ¹⁾	Pick-up		0.5...0.8				0.5...0.8				0.5...0.8				0.7...0.85		0.7...0.85		0.7...0.85	
	Sealing		0.2...0.6				0.2...0.6				0.25...0.6				0.4...0.6		0.4...0.6		0.4...0.6	
Power consumption of the coil - DC coils																				
Pick-up	(W)		-				240				340				403		529		644	
Sealing	(W)		-				6				6.5				11		14.3		24.2	
Number of terminals	AC coil		4				4				3				2					
	DC coil		-				4				3				2					

Note: 1) Values applicable for contactors CWM112...300 with electronic module. For contactors with standard coil only on request.

CWM Contactors - Technical Data

Main Contacts

Reference code			CWM9	CWM12	CWM18	CWM25	CWM32	CWM40	CWM50	CWM65	CWM80	CWM95	CWM105	CWM112	CWM150	CWM180	CWM250	CWM300		
Rated operational current I _e	AC-3 (U _e ≤ 440 V)	(A)	9	12	18	25	32	40	50	65	80	95	105	112	150	180	250	300		
	AC-4 (U _e ≤ 440 V)	(A)	5	7	8	12	16	18.5	23	30	37	44	50	63	69	73	110	145		
	AC-1 (θ ≤ 55 °C, U _e ≤ 690 V)	(A)	25	25	32	45	60	60	90	110	110	140	140	180	225	225	350	410		
Rated operational voltage U _e	IEC/EN 60947-4-1, VDE 0660	(V)	690						1,000											
	UL, CSA	(V)	600																	
Rated thermal current I _m (θ ≤ 55 °C)		(A)	25	25	32	45	60	60	90	110	110	140	140	180	225	225	350	410		
Making capacity - IEC/EN 60947		(A)	300	300	300	450	550	550	1,000	1,000	1,000	1,280	1,280	1,430	1,820	2,100	2,600	3,000		
Breaking capacity IEC/EN 60947	(U _e ≤ 400 V)	(A)	250	250	250	350	450	450	920	920	920	1,050	1,050	1,290	1,350	1,400	2,000	-		
	(U _e = 500 V)	(A)	250	250	250	320	450	450	920	920	920	1,050	1,050	1,290	1,350	1,400	2,000	-		
	(U _e = 690 V)	(A)	130	130	130	170	205	205	780	780	780	950	950	-	-	-	-	-		
Short-time current No current flowing during recovery time	1 sec	(A)	455	455	570	630	1,010	1,265	1,580	2,530	2,530	3,300	3,300	3,165	3,763	4,649	4,427	-		
	5 sec	(A)	205	205	254	280	450	450	710	1,130	1,130	1,485	1,485	1,820	2,164	2,673	2,546	-		
	10 sec	(A)	144	144	180	200	320	400	500	800	800	1,050	1,050	1,430	1,700	2,100	2,000	-		
	30 sec	(A)	85	85	104	115	185	230	290	460	460	600	600	826	980	1,212	1,155	-		
	10 min. and θ ≤ 40 °C)	1 min	(A)	60	60	74	80	130	165	205	325	325	430	430	584	694	857	816	-	
	3 min	(A)	35	35	46	50	90	100	120	185	185	250	250	337	401	495	471	-	-	
Protection against short-circuits with fuses(gL/gG)	@600 V - UL/CSA	(kA)	5						10						18					
	Coordination type 1	(A)	50	50	63	63	100	125	200	200	200	250	250	-	355	355	500	630		
	Coordination type 2	(A)	25	35	35	50	63	80	100	125	125	160	200	224	250	250	400	500		
Impedance per pole		(mΩ)	2.4	2.4	2.4	1.7	1.3	1.0	0.9	0.9	0.9	0.8	0.8	0.5	0.5	0.45	0.3	0.3		
Power dissipation per pole	AC-1	(W)	1.5	1.5	2.5	3.3	4.6	3.4	6.7	10.4	10.4	14.9	14.9	16	25	21.6	35	45.7		
	AC-3	(W)	0.2	0.3	0.8	1.0	1.3	1.5	2.1	3.6	5.5	6.9	8.4	6.2	11.1	13.8	17.9	25.7		
Utilization category AC-3																				
Rated operational current I _e (θ ≤ 55 °C)	U _e ≤ 440 V	(A)	9	12	18	25	32	40	50	65	80	95	105	112	150	180	250	300		
	U _e ≤ 500 V	(A)	7.5	10.5	14	19	24	32	38	55	63	79	85	95	130	155	220	265		
	U _e ≤ 690 V	(A)	7	9	13	15	22	25	34	44	48	60	67	82	110	135	185	220		
	U _e ≤ 1,000 V	(A)	Not available						19	25	30	37	40	42	48	68	103	126		
Rated operational power	220 / 230 V	(kW)	2.2	3	4.5	5.5	9.2	11	15	18.5	22	22	30	30	45	55	75	90		
		(HP)	3	4	6	7.5	12.5	15	20	25	30	30	40	40	60	75	100	125		
	380 / V	(kW)	3.7	5.5	7.5	11	15	18.5	22	30	37	45	55	55	75	90	132	150		
		(HP)	5	7.5	10	15	20	25	30	40	50	60	75	75	100	125	175	200		
	400 / 415 V	(kW)	3.7	5.5	7.5	11	15	18.5	22	30	37	45	55	55	75	110	132	150		
		(HP)	5	7.5	10	15	20	25	30	40	50	60	75	75	100	150	175	200		
	440 V	(kW)	4.5	5.5	9.2	11	15	22	30	37	45	55	55	55	90	110	150	185		
		(HP)	6	7.5	12.5	15	20	30	40	50	60	75	75	75	125	150	200	250		
	500 V	(kW)	4.5	5.5	9.2	11	15	22	30	37	45	55	55	55	90	110	150	185		
		(HP)	6	7.5	12.5	15	20	30	40	50	60	75	75	75	125	150	200	250		
	660 / 690 V	(kW)	5.5	7.5	11	11	18.5	22	30	37	45	55	55	75	110	110	150	185		
		(HP)	7.5	10	15	15	25	30	40	50	60	75	75	100	150	150	200	250		
Percentage of the maximum operational current at	600 ops./h	(%)	100	100	100	100	100	100	100	100	100	100	100	100	100	100	100	100		
	1,200 ops./h	(%)	100	100	100	100	100	100	100	100	100	75	75	75	75	75	75	75		
	3,000 ops./h	(%)	35	35	35	35	35	35	35	35	35	25	25	25	25	25	25	25		
Utilization category AC-4																				
Rated operational current I _e AC-4 (U _e ≤ 690 V)		(A)	5	7	8	12	16	18.5	23	30	37	44	50	50	55	58	88	116		
Rated operational power	220 / 230 V	(kW)	1.1	1.5	1.5	3	3.7	4.5	55	7.5	9.2	11	11	18.5	18.5	22	37	45		
		(HP)	1.5	2	2	4	5	6	7.5	10	12.5	15	15	25	25	30	50	60		
	380 / 400 V	(kW)	2.2	3	3.7	5.5	7.5	9.2	11	15	18.5	22	22	30	30	37	55	75		
		(HP)	3	4	5	7.5	10	12.5	15	20	25	30	30	40	40	50	75	100		
	415 V	(kW)	2.2	3.7	4.5	5.5	9.2	11	11	15	22	22	30	37	37	45	55	75		
		(HP)	3	5	6	7.5	12.5	15	15	20	30	30	40	50	50	60	75	100		
	440 V	(kW)	2.2	3.7	4.5	5.5	9.2	11	11	15	22	22	30	37	37	45	55	75		
		(HP)	3	5	6	7.5	12.5	15	15	20	30	30	40	50	50	60	75	100		
	500 V	(kW)	3	3.7	5.5	7.5	9.2	11	15	18.5	22	22	30	37	45	45	75	90		
		(cv)	4	5	7.5	10	12.5	15	20	25	30	30	40	50	60	60	100	125		
	660 / 690 V	(kW)	3	4.5	5.5	7.5	11	11	15	18.5	22	30	30	40	45	45	90	90		
		(cv)	4	6	7.5	10	15	15	20	25	30	40	40	60	60	75	125	125		

CWM Contactors - Technical Data

Main Contacts

Reference code		CWM9	CWM12	CWM18	CWM25	CWM32	CWM40	CWM50	CWM65	CWM80	CWM95	CWM105	CWM112	CWM150	CWM180	CWM300	
Utilization category AC-1																	
		3P (NO) or 4P (4NO)				3P (NO)						3P (NO)					
Rated thermal current I_{th} ($\theta \leq 55^\circ\text{C}$)	(A)	25	25	32	45	60	60	90	110	110	140	140	180	225	225	410	
Max. operational current at ambient temperature of (up to 690 V)	$\theta \leq 55^\circ\text{C}$	(A)	25	25	32	45	60	60	90	110	110	140	140	160	190	200	350
	$\theta \leq 70^\circ\text{C}$	(A)	20	20	25	32	48	48	72	88	88	110	110	120	145	145	250
	$\theta \leq 75^\circ\text{C}$	(A)	17	17	22	26	42	42	63	77	77	95	95	101	124	120	206
Max. operational power $\theta \leq 55^\circ\text{C}$ (Three-phase resistors)	220 / 230 V	(kW)	9.5	9.5	12	17	22.5	22.5	34	42	42	53	53	68	85	85	156
	380 / 400 V	(kW)	16.5	16.5	21	29.5	39.5	39.5	59	72.5	72.5	92	92	118	145	145	270
	415 / 440 V	(kW)	19	19	24	34	45.5	45.5	68.5	84	84	106.5	106.5	130	160	160	295
	500 V	(kW)	21.5	21.5	27.5	39	52	52	77	95	95	121	121	155	190	190	355
	575 / 600 V	(kW)	24.1	24.1	30.9	43.4	57.9	57.9	86.8	106.1	106.1	135.1	135.1	180	225	225	400
660 / 690 V	(kW)	28.5	28.5	38	51	68.5	68.5	100	125	125	160	160	205	255	255	470	
Cable size	(mm ²)	4	4	6	10	16	16	35	35	35	50	50	120	120	120	2 x 150	
Current values for connection of	2 poles in parallel	$I_s \times 1.7$															
	3 poles in parallel	$I_s \times 2.4$															
	4 poles in parallel	$I_s \times 3.2$															
Percentage of the maximum operational current at	600 ops./h	(%)	100	100	100	100	100	100	100	100	100	100	100	100	100	100	100
	1,200 ops./h	(%)	100	100	100	100	100	100	100	100	80	80	80	80	80	80	80
	3,000 ops./h	(%)	50	50	50	50	50	50	50	50	50	40	40	40	40	40	40
Max. operational power $\theta \leq 55^\circ\text{C}$ (Resistive loads)	220 / 230 V	(kW)	5.5	5.5	7.04	9.9	13.2	14.9	22.2	27.5	27.5	34.1	34.1	-	-	-	-
	380 / 400 V	(kW)	9.5	9.5	12.1	17.1	22.8	25.8	38.6	47.5	47.5	58.9	58.9	-	-	-	-
	415 / 440 V	(kW)	10.3	10.3	13.2	18.6	24.9	28.2	42.3	51.8	51.8	64.3	64.3	-	-	-	-
	500 V	(kW)	12.5	12.5	16	22.5	30	34	50.6	62.5	62.5	77.5	77.5	-	-	-	-
	660 / 690 V	(kW)	16.5	16.5	21.1	29.7	39.6	44.8	66	82.5	82.5	102.3	102.3	-	-	-	-

UL Power

Reference code		CWM9	CWM12	CWM18	CWM25	CWM32	CWM40	CWM50	CWM65	CWM80	CWM95	CWM105	CWM112	CWM150	CWM180	CWM250	CWM300	
General purpose current	(600 V)	(A)	25	25	32	32	60	60	90	110	110	140	140	170	200	200	300	400
1-phase	110 / 120 V	(HP)	0.75	0.75	1	2	3	3	5	5	7.5	7.5	10	-	-	-	-	-
	220 / 240 V	(HP)	1.5	2	3	5	5	5	7.5	10	15	15	20	-	-	-	-	-
3-phase	200 V	(HP)	3	3	5	7.5	10	10	15	20	20	25	30	40	50	60	75	100
	220 / 240 V	(HP)	3	3	5	7.5	10	15	15	20	25	30	40	50	60	75	100	125
	440 / 480 V	(HP)	5	7.5	10	15	20	30	40	50	50	60	75	100	125	150	200	250
	550 / 600 V	(HP)	7.5	10	15	15	25	25	40	50	60	75	75	100	150	200	250	350



CWM Contactors - Technical Data

General Data and Main Contacts

Reference code	CWM400	CWM500	CWM630	CWM800
Standards	IEC 60947 / UL 508			
Rated insulation voltage U_i IEC 60947 UL	1,000 V 600 V			
Rated impulse withstand voltage U_{imp}	6 kV			
Rated operational frequency	25 - 400 Hz			
Degree of protection Main circuits Control circuits and auxiliary contacts	IP00 IP20			
Ambient temperature Operating temperature Storage temperature	-25 °C to + 55 °C -55 °C to + 80 °C			
Altitude Normal values 90% I_g / 80% U_g 80% I_g / 75% U_g	Up to 3,000 m 3,000 to 4,000 m 4,000 to 5,000 m			
Overvoltage category / Pollution degree	III / 3			
Climatic proofing	Acc. to IEC 60680-2			
Pole numbers of main circuits	3			
Rated operation voltage U_g	690 V			
Conv. thermal current I_{th} at < 55 °C rated operational current le/AC-1 (A)	450	580	660	900
Rated operational current I_g AC-4 ($U_g \leq 440$ V) (A)	300	350	400	630
AC-3 utilization category Rated operational power 220-230 V (kW)	125	150	190	220
400-415 V (kW)	220	265	330	440
440 V (kW)	220	265	330	440
500 V (kW)	225	265	330	500
690 V (kW)	250	300	330	500
Short-circuit rating max. fuse gL-gG (A)	630	800	800	1,000
Max. electrical operational per hour AC-1 Ops/h	300	300	300	300
AC-3 Ops/h	1,200	1,200	1,200	1,200
AC-4 Ops/h	150	150	150	150
No load Ops/h	1,200	1,200	1,200	1,200
Mechanical lifespan Ops x 10 ⁶	5			
Electrical lifespan (AC-3) Ops x 10 ⁶	0.5			0.6

UL Power Ratings

Reference code	CWM400	CWM500	CWM630	CWM800
General purpose current (600 V) (A)	450	580	660	900
3-phase	200 V (HP)	125	150	200
	220 / 240 V (HP)	150	200	300
	440 / 480 V (HP)	300	400	600
	550 / 600 V (HP)	300	400	600

Control Circuit



Reference code (3 pole and 4 pole contactors)	CWM400	CWM500	CWM630	CWM800
Coil operation limit	0.85...1.1 x U_g			
Pick-up (xUs)	0.78		0.75	
Drop-out (xUs)	0.30...0.60		0.30...0.60	
Coil consumption	Closing (VA)	571	1,000	
	Closed (VA)	14	29	
	Dissipation (W)	5	7.8	
Number of terminals	2			

CWM Contactors - Technical Data

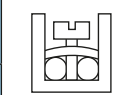
Terminal Capacity and Tightening Torque - Power Terminals

Reference code		CWM9 / CWM12 / CWM18			CWM25		
Screw type		M3.5x 9 Flat / Phillips			M4x 12 Flat / Phillips		
Power terminal capacity ¹⁾		Finely stranded with end sleeve	Stranded and finely stranded without end sleeve	Solid	Finely stranded with end sleeve	Stranded and finely stranded without end sleeve	Solid
mm ²		1x 0.5...4 2x 0.5...2.5	1x 1...6 2x 1...2.5 2x 2.5...6	1x 0.5...6 2x 0.5...2.5 2x 2.5...6	1x 1...10 2x 1...2.5 2x 2.5...6	1x 2.5...10 2x 2.5...10	1x 1...10 2x 1...2.5 2x 2.5...10
AWG (UL)		14...10			14...8		
Tightening torque (N.m)		1...1.5			1.6...2.5		
Tightening torque (lb.in) (UL)		15			16		

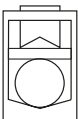
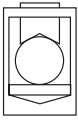
Note: this information is also valid for built-in auxiliary terminals for CWM9 to CWM18.

Reference code		CWM32 / CWM40			CWM50 / CWM65 / CWM80			CWM95 / CWM105		
Screw type		M4x 16.5 Flat / Phillips			M8 Allen 4mm			M10 Allen 4mm		
Power terminal capacity		Finely stranded with end sleeve	Stranded and finely stranded without end sleeve	Solid	Finely stranded with end sleeve	Stranded and finely stranded without end sleeve	Solid	Finely stranded with end sleeve	Stranded and finely stranded without end sleeve	Solid
One conductor on bottom										
mm ²		1...16	1.5...16	1...16	2.5...35	6...35	2.5...35	4...35	6...35	4...35
AWG (UL)		14...8			14...1/0			10...1/0		
One conductor on top										
mm ²		0.75...16	1...16	0.75...16	1...35	1.5...35	1...35	1.5...50	2.5...50	1.5...50
AWG (UL)		14...8			14...1/0			10...1/0		
Two conductors at the same time - bottom conductor										
mm ²		1...16	1.5...16	1...16	2.5...25	6...35	2.5...35	4...35	6...35	4...35
AWG (UL)		14...8			14...1/0			10...1/0		
Two conductors at the same time - top conductor										
mm ²		0.75...16	1...16	0.75...16	1...25	1.5...35	1...35	1.5...50	2.5...50	1.5...50
AWG (UL)		14...8			14...1/0			10...1/0		
Tightening torque (N.m)		2...2.5			4...6			5...6.5		
Tightening torque (lb.in) (UL)		22			40			60		

Reference code		CWM112 / CWM150		CWM180		CWM250 / CWM300		CWM400		CWM500 / CWM630		CWM800	
Screw type		M6 Hexagon head		M8 Hexagon head		M10 Hexagon head		M12 Hexagon head		M16 Hexagon head		M16 Hexagon head	
Main terminal capacity		Solid and stranded with end sleeve	Busbars	Solid and stranded with end sleeve	Busbars	Solid and stranded with end sleeve	Busbars	Solid and stranded with end sleeve	Busbars	Solid and stranded with end sleeve	Busbars	Solid and stranded with end sleeve	Busbars
mm ²		2x 25...70	2 x (15 x 3)	2x 50...120	2 x (20 x 3)	2x 50...150	2 x (30 x 5)	2x 120...185	2x (30x5)	2x 185...300	2x (50x5)	2x 185...300	2x (60x5)
AWG (UL)		2x 2...3/0	-	2x 1/0...250	-	2x 1/0...300	-	2x 250...400	-	2x 400...600	-	2x 400...600	-
Tightening torque (N.m)		5.4...6		14...16		23...26		23...26		54...60			

CWM Contactors - Technical Data

Terminal Capacity and Tightening Torque - Coil Terminals

Reference code	CWM9...105			CWM112...300		
Screw type	M3.5x 10 Flat / Phillips			M3.5x 10 Flat / Phillips		
Coil terminal	Finely stranded with end sleeve	Stranded and finely stranded without end sleeve	Solid	Finely stranded with end sleeve	Stranded and finely stranded without end sleeve	Solid
mm ²	1x 0.5...4 2x 0.5...1.5 2x 1...2.5	1x 1...4 2x 1...2.5	1x 0.5...4 2x 0.5...1.5 2x 1...2.5	1x 0.5...4 2x 0.5...1.5 2x 1...2.5	1x 1...4 2x 1...2.5	1x 0.5...4 2x 0.5...1.5 2x 1...2.5
AWG (UL)	1x 20...10 2x 20...14 2x 16...12	1x 16...10 2x 16...12	1x 20...10 2x 20...14 2x 16...12	1x 20...10 2x 20...14 2x 16...12	1x 16...10 2x 16...12	1x 20...10 2x 20...14 2x 16...12
Tightening torque (N.m)	0.8...1.1			0.8...1.1		
Tightening torque (lb.in) (UL)	10			10		

Reference code	CWM400...CWM800		
Screw type	M4 Flat / Phillips		
Coil terminal	Finely stranded with end sleeve	Stranded and finely stranded without end sleeve	Solid
mm ²	1x 1.25...5.5 or 2x 1.25...5.5		
AWG (UL)	16...10		
Tightening torque (N.m)	2...2.3		
Tightening torque (lb.in) (UL)	17.7...20.3		

Terminal Capacity and Tightening Torque - Auxiliary Contact Blocks

Reference code	BCXMF BCXML		
Screw type	M3.5x9 Fenda / Philips		
Auxiliary contact block	Finely stranded with end sleeve	Stranded and finely stranded without end sleeve	Solid
mm ²	1x 0.5...4 2x 0.5...2.5	1x 0.75...2.5 2x 0.75...2.5	1x 0.5...4 2x 0.5...2.5
AWG (UL)	22...12		
Tightening torque (N.m)	0.8...1.1		
Tightening torque (lb.in) (UL)	10		

CWM Contactors - Technical Data

Auxiliary Contacts

Reference code	Built-in auxiliary contacts of contactors			Auxiliary contact blocks		
	CWM9	CWM12	CWM18	BCXMF...	BCXML...	BCXMF_AU
Rated insulation voltage U_i IEC/EN 60 947 UL/CSA	(V)	1,000			1,000	
	(V)	600			600	
Rated operational voltage U_e	(V)	690			690	
Conv. thermal current I_{th}	(A)	16			10	
Rated operational current I_c						
AC-15	220 - 240 V (A)	10		10		4
	380 - 400 V (A)	6		4		3
	415 V (A)	5		3.5		-
	500 V (A)	4		2.5		2
UL/CSA		A600		A600		A600
DC-13	24 V (A)	6		4		4
	48 V (A)	4		2		2
	110 V (A)	2		0.7		0.55
	220 V (A)	0.7		0.3		0.3
UL/CSA		P600		Q600		Q600
Making capacity I_m						
AC-15/AC-11	$U_e \leq 400$ V 50/60 Hz (A)	250		90		90
AC-13/DC-11	$U_e \leq 220$ V dc (A)	250		90		-
Breaking capacity I_c						
AC-15/AC-11	$U_e \leq 400$ V 50/60 Hz (A)	250		60		60
AC-13/DC-11	$U_e \leq 220$ V dc (A)	2		0.95		-
Short-circuit protection max. fuse gL/gG	(A)	10		10		
Control circuit reliability			I_c min = 5 mA U_e min = 17 V			I_c min = 1 mA U_e min = 17 V
Electrical lifespan	Ops		10^6			
Mechanical lifespan	Ops		10×10^6			

Reference code	BCXML11 CWM800 / BCXMRL11 CWM800	
Conv. thermal current I_{th}	(A)	16
Rated operational current I_c		
AC category (A600)		
	110 V (A)	AC-15 6
	220 V (A)	5
	440 V (A)	3
	600 V (A)	3
DC category (P600)		
	24 V (A)	DC-13 6
	48 V (A)	3
	110 V (A)	1.2
	220 V (A)	0.2
Mechanical lifespan	Ops x 10^6	10
Electrical lifespan		
Operations x 10^6	AC-15	0.5
	AC-12	0.25
	DC-13 / DC-12	0.5
Max. electrical operational per hour		1,800

CWM Contactors - Technical Data

Contactors for Lighting Circuits

Lamp type	W	A	μF	Maximum number of lamps per phase at 220 V										
				CWM9	CWM12	CWM18	CWM25	CWM32	CWM40	CWM50	CWM65	CWM80	CWM95	CWM105
Incandescent	60	0.27	-	62	62	70	77	85	122	156	191	222	264	284
	100	0.45	-	40	40	50	60	66	73	95	116	133	160	170
	200	0.91	-	20	20	25	30	33	36	47	58	66	79	84
	300	1.36	-	13	13	17	20	22	24	31	38	44	53	56
	500	2.27	-	8	8	10	12	12	14	19	23	26	31	33
	1,000	4.50	-	4	4	5	6	6	7	9	11	13	16	16
	2,000	9.1	-	1	1	2	3	3	3	4	5	6	8	8
		AC-5b ¹⁾		(A)	18	18	23	27	30	33	43	52	60	73
Fluorescent Single arrangement Without compensation	15	0.23	-	88	98	126	155	224	237	355	390	434	496	553
	20	0.37	-	57	61	78	110	139	147	221	243	270	309	344
	40	0.44	-	48	51	66	93	118	124	186	204	227	260	289
	65	0.7	-	30	32	41	58	74	78	116	127	142	163	181
Fluorescent Single arrangement With compensation	15	0.23	3.5	61	77	94	111	134	149	191	232	273	312	347
	20	0.25	4.5	48	61	74	87	103	115	148	180	212	243	270
	40	0.3	4.5	48	61	74	87	103	115	148	180	212	243	270
	65	0.45	7	31	39	47	56	66	74	95	115	136	155	173
High pressure Mercury vapour Without compensation	100	1.5	-	14	16	19	27	34	36	54	59	66	76	85
	250	2.13	-	6	8	10	12	15	18	27	30	33	36	42
	400	3.25	-	4	5	6	8	10	12	18	20	22	24	28
	700	5.4	-	2	3	4	5	6	7	11	12	13	14	17
High pressure Mercury vapour With compensation	1,000	7.5	-	2	2	3	3	4	5	8	9	9	10	12
	250	1.3	20	11	14	18	22	27	33	49	55	60	66	77
	400	2.1	25	7	9	11	14	17	20	31	34	37	41	48
	700	3.6	40	4	5	6	8	10	12	18	20	22	24	28
High pressure Sodium vapour Without compensation	1,000	5.3	60	3	3	4	5	7	8	12	13	15	16	19
	250	3	-	4	5	7	9	11	13	19	21	24	26	30
	400	4.4	-	3	4	5	6	7	9	13	15	16	18	20
High pressure Sodium vapour With compensation	1,000	10.3	-	1	2	2	2	3	4	6	6	7	7	9
	250	1.45	40	10	12	16	20	25	30	44	49	54	59	69
	400	2.5	45	6	7	9	11	14	17	26	29	31	34	40
Metal iodide Without compensation	1,000	5.5	100	3	3	4	5	6	8	12	13	14	16	18
	250	2.17	-	4	5	7	9	12	12	19	21	23	25	29
	400	3.48	-	3	3	4	6	8	8	12	13	14	16	18
	700	6.09	-	1	2	2	3	4	4	7	7	8	9	10
	2,000	17.39	-	1	1	1	1	2	2	2	3	3	3	4
Metal iodide With compensation	1,000	8.7	-	1	1	2	2	3	3	5	5	6	6	7
	250	1.4	32	7	9	11	16	21	21	32	36	39	43	50
	400	2	45	5	6	8	11	15	15	23	25	28	30	35
	700	3.6	65	3	3	4	6	8	8	13	14	15	17	19
	2,000	10.6	100	1	1	2	2	3	3	4	5	5	6	7

Note: indicative values - It's highly recommended to take into consideration the values of making capacity and rated AC-1 current when dimensioning the contactor for AC-5b utilization category (AC-5b - Switching of incandescent lamps).

CWM Contactors - Technical Data

Contactors for Lighting Circuits

Lamp type	W	A	μF	Maximum number of lamps per phase at 220 V				
				CWM112	CWM150	CWM180	CWM250	CWM300
Incandescent	60	0.27	-	318	404	467	578	667
	100	0.45	-	193	245	283	350	404
	200	0.91	-	95	121	140	173	200
	300	1.36	-	64	81	93	116	133
	500	2.27	-	38	49	56	69	80
	1,000	4.50	-	19	24	28	35	40
	2,000	9.1	-	10	12	14	17	20
		AC-5b ¹⁾ (A)			87	110	127	158
Fluorescent Single arrangement Without compensation	15	0.23	-	652	815	978	1,522	1,783
	20	0.37	-	405	507	608	946	1,108
	40	0.44	-	341	426	511	795	932
	65	0.7	-	214	268	321	500	586
	100	1.5	-	100	125	150	233	273
Fluorescent Single arrangement With compensation	15	0.23	3.5	409	520	600	743	857
	20	0.25	4.5	318	404	467	578	667
	40	0.3	4.5	318	404	467	578	667
	65	0.45	7	204	260	300	371	429
	100	0.7	18	79	101	117	144	167
High pressure Mercury vapour Without compensation	250	2.13	-	54	62	68	106	124
	400	3.25	-	36	40	45	69	81
	700	5.4	-	21	24	27	42	49
	1,000	7.5	-	15	18	19	30	35
High pressure Mercury vapour With compensation	250	1.3	20	79	100	116	143	165
	400	2.1	25	63	80	92	114	132
	700	3.6	40	39	50	58	72	83
	1,000	5.30	60	26	33	39	48	55
High pressure Sodium vapour Without compensation	250	3.0	-	39	44	48	75	88
	400	4.4	-	26	30	33	51	60
	1,000	10.3	-	11	13	14	22	26
High pressure Sodium vapour With compensation	250	1.45	40	45	57	66	81	94
	400	2.5	45	40	51	58	72	83
	1,000	5.5	100	18	23	26	33	38
Metal iodide Without compensation	250	2.17	-	37	42	47	73	85
	400	3.48	-	23	26	29	45	53
	700	6.09	-	13	15	17	26	30
	1,000	8.7	-	9	11	12	18	21
	2,000	17.39	-	5	5	6	9	11
Metal iodide With compensation	250	1.4	32	56	71	82	102	117
	400	2	45	40	51	58	72	83
	700	3.6	65	28	35	40	50	58
	1,000	5.3	85	21	27	31	38	44
	2,000	10.6	100	18	23	26	33	38

Note: indicative values - It's highly recommended to take into consideration the values of making capacity and rated AC-1 current when dimensioning the contactor for AC-5b utilization category (AC-5b - Switching of incandescent lamps).

CWM Contactors - Technical Data

DC - Utilization Category

Utilization Category DC-1 (L/R ≤ 1ms)

Reference code	CWM9	CWM12	CWM18	CWM25	CWM32	CWM40	CWM50	CWM65	CWM80	CWM95	CWM105	
U_e	Poles in series											
	Maximum operational current I_e (A)											
≤ 24 V	1	18	18	18	25	32	40	50	65	65	80	80
	2	25	25	32	45	60	60	90	110	110	140	140
	3	25	25	32	45	60	60	90	110	110	140	140
	4	25	25	32	-							
≤ 48 V	1	15	15	15	20	25	35	45	55	55	70	70
	2	25	25	32	45	60	60	90	110	110	140	140
	3	25	25	32	45	60	60	90	110	110	140	140
	4	25	25	32	-							
≤ 60 V	1	12	12	12	18	18	32	40	50	50	65	65
	2	25	25	32	45	60	60	90	110	110	140	140
	3	25	25	32	45	60	60	90	110	110	140	140
	4	25	25	32	-							
≤ 125 V	1	6	6	6	8	8	8	16	16	16	16	16
	2	18	18	18	25	45	45	80	90	90	110	110
	3	25	25	25	32	60	60	90	110	110	140	140
	4	25	25	32	-							
≤ 220 V	1	0.8	0.8	0.8	0.8	1	1	2	2	2	2	2
	2	7.5	7.5	7.5	8	8	8	20	20	20	20	20
	3	25	25	25	32	50	50	90	110	110	140	140
	4	25	25	32	-							
≤ 440 V	1	0.4	0.4	0.4	0.4	0.5	0.5	0.8	0.8	0.8	0.8	0.8
	2	0.8	0.8	0.8	0.8	1	1	2	2	2	2	2
	3	8	8	8	10	10	10	15	15	15	15	15
	4	15	15	15	-							
≤ 600 V	1	-	-	-	-	-	-	-	-	-	-	-
	2	0.4	0.4	0.4	0.4	0.5	0.5	1	1	1	1	1
	3	4	4	4	5	5	5	7.5	7.5	7.5	7.5	7.5
	4	8	8	10	-							

Utilization Category DC-3 (L/R ≤ 2.5ms)

Reference code	CWM9	CWM12	CWM18	CWM25	CWM32	CWM40	CWM50	CWM65	CWM80	CWM95	CWM105	
U_e	Poles in series											
	Maximum operational current I_e (A)											
≤ 24 V	1	12	12	12	18	25	32	40	50	50	65	65
	2	18	18	18	25	40	40	65	80	80	105	105
	3	18	18	18	25	40	40	65	80	80	105	105
	4	18	18	18	-							
≤ 48 V	1	9	9	9	12	18	20	30	35	35	45	45
	2	18	18	18	25	40	40	65	80	80	105	105
	3	18	18	18	25	40	40	65	80	80	105	105
	4	18	18	18	-							
≤ 60 V	1	7.5	7.5	7.5	10	15	15	25	30	30	35	35
	2	18	18	18	25	40	40	65	80	80	105	105
	3	18	18	18	25	40	40	65	80	80	105	105
	4	18	18	18	-							
≤ 125 V	1	2	2	2	2	3	3	3	3	3	3	3
	2	10	10	12	18	25	32	50	60	60	85	85
	3	15	15	18	25	32	40	65	80	80	105	105
	4	15	15	18	-							
≤ 220 V	1	0.6	0.6	0.6	0.6	0.6	0.6	0.8	0.8	0.8	0.8	0.8
	2	2	2	2	2	2	2	7	7	7	7	7
	3	12	12	12	18	25	32	50	65	65	95	95
	4	12	15	18	-							
≤ 440 V	1	-	-	-	-	-	-	-	-	-	-	-
	2	0.3	0.3	0.3	0.3	0.5	0.5	1	1	1	1	1
	3	1.5	1.5	1.5	1.5	3	3	3	3	3	3	3
	4	1.5	6	6	-							
≤ 600 V	1	-	-	-	-	-	-	-	-	-	-	-
	2	-	-	-	-	-	-	-	-	-	-	-
	3	0.8	0.8	0.8	0.8	1.5	1.5	1.5	1.5	1.5	1.5	1.5
	4	1	2.5	2.5	-							

CWM Contactors - Technical Data

DC - Utilization Category

Utilization Category DC-5 (L/R ≤ 15ms)

Reference code	CWM9	CWM12	CWM18	CWM25	CWM32	CWM40	CWM50	CWM65	CWM80	CWM95	CWM105	
U_e	Poles in series											
	Maximum operational current I_e (A)											
≤ 24 V	1	12	12	12	18	25	32	40	50	50	65	65
	2	18	18	18	25	40	40	65	80	80	105	105
	3	18	18	18	25	40	40	65	80	80	105	105
	4	18	18	18	-							
≤ 48 V	1	9	9	9	12	18	20	30	35	35	45	45
	2	18	18	18	25	40	40	65	80	80	105	105
	3	18	18	18	25	40	40	65	80	80	105	105
	4	18	18	18	-							
≤ 60 V	1	7.5	7.5	7.5	10	15	15	25	30	30	35	35
	2	18	18	18	25	40	40	65	80	80	105	105
	3	18	18	18	25	40	40	65	80	80	105	105
	4	18	18	18	-							
≤ 125 V	1	0.8	0.8	0.8	0.8	1.2	1.2	1.2	1.2	1.2	1.2	1.2
	2	5	5	5	5	5	5	50	60	60	80	80
	3	15	15	15	20	25	32	60	70	70	95	95
	4	15	15	18	-							
≤ 220 V	1	-	-	-	-	-	-	0.5	0.5	0.5	0.5	0.5
	2	0.8	0.8	0.8	0.8	0.8	0.8	3	3	3	4	4
	3	3	3	3	3	3	3	7	7	7	7	7
	4	10	10	10	-							
≤ 440 V	1	-	-	-	-	-	-	-	-	-	-	-
	2	-	-	-	-	-	-	-	-	-	-	-
	3	0.4	0.5	0.5	0.5	0.7	0.7	1	1	1	1	1
	4	1.5	2	2	-							
≤ 600 V	1	-	-	-	-	-	-	-	-	-	-	-
	2	-	-	-	-	-	-	-	-	-	-	-
	3	-	-	-	-	-	-	-	-	-	-	-
	4	0.5	0.75	0.75	-							

Utilization Category DC-1 (L/R ≤ 1ms)

Reference code	CWM112	CWM150	CWM180	CWM250	CWM300
U_e	Poles in series				
	Maximum operational current I_e (A)				
≤ 24 V	1	160	160	200	300
	2	180	225	225	350
	3	180	225	225	350
≤ 110 V	1	18	18	18	33
	2	112	150	170	250
	3	180	225	225	350
≤ 220 V	1	-	-	-	-
	2	90	120	140	200
	3	180	225	225	350
≤ 440 V	1	-	-	-	-
	2	-	-	-	-
	3	85	105	105	165



CWM Contactors - Technical Data

DC - Utilization Category

Utilization Category DC-3 / DC-5 (L/R ≤ 15ms)

Reference code		CWM112	CWM150	CWM180	CWM250	CWM300
U _e	Poles in series	Maximum operational current I _e (A)				
≤ 24 V	1	112	112	180	250	250
	2	112	150	180	250	300
	3	112	150	180	250	300
≤ 110 V	1	18	18	18	33	33
	2	80	95	105	185	205
	3	112	150	180	250	300
≤ 220 V	1	-	-	-	-	-
	2	55	55	65	70	80
	3	80	120	150	200	200
≤ 440 V	1	-	-	-	-	-
	2	-	-	-	-	-
	3	27	40	50	67	67

Utilization Category DC-1 (L/R ≤ 1ms)

Reference code		CWM400	CWM500	CWM630	CWM800
U _e	Poles in series	Maximum operational current I _e (A)			
≤ 24 V	2	400	580	630	800
	3	400	580	630	800
≤ 48 V	2	240	580	630	800
	3	400	580	630	800
≤ 110 V	2	200	520	630	630
	3	400	580	630	800
≤ 220 V	2	200	450	630	630
	3	300	580	630	800

Utilization Category DC-2 / DC-4 (L/R ≤ 15ms)

Utilisation category		CWM400	CWM500	CWM630	CWM800
U _e	Poles in series	Maximum operational current I _e (A)			
≤ 24 V	2	400	580	630	800
	3	400	580	630	800
≤ 48 V	2	200	580	630	630
	3	280	580	630	630
≤ 110 V	2	150	500	630	630
	3	200	550	630	630
≤ 220 V	2	90	480	630	630
	3	150	500	630	630

1 Poles in Series



3 Poles in Series

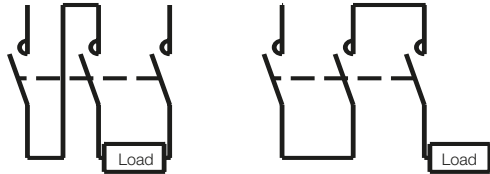

2 Poles in Series

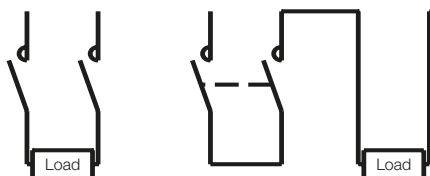

4 Poles in Series

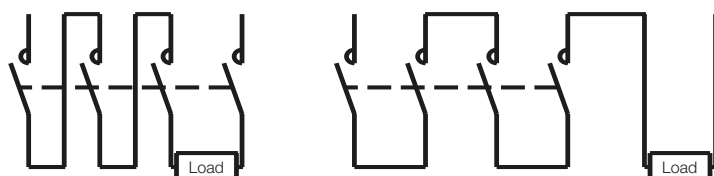

CWM Contactors - Technical Data

Terminal Markings to EN 50012

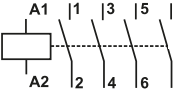
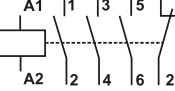
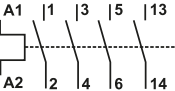
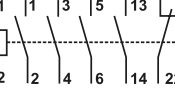
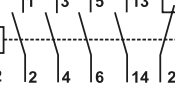
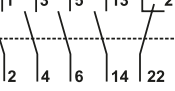
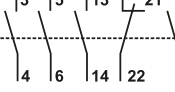
Diagram	Distinctive number and version of combination	NO	NC	Reference code	Additional auxiliary contact blocks
Without auxiliary contact blocks					
	10E	1	0	CWM9-10 CWM12-10 CWM18-10	-
	01E	0	1	CWM9-01 CWM12-01 CWM18-01	-
Front mounting auxiliary contact blocks BCXMF10 or BCXMF01					
	11E	1	1	CWM9-10 CWM12-10 CWM18-10	+ BCXMF01
	21E	2	1	CWM9-10 CWM12-10 CWM18-10	+ BCXMF10 + BCXMF01
	12E	1	2	CWM9-10 CWM12-10 CWM18-10	+ 2 BCXMF01
	31E	3	1	CWM9-10 CWM12-10 CWM18-10	+ 2 BCXMF10 + BCXMF01
	41E	4	1	CWM9-10 CWM12-10 CWM18-10	+ 3 BCXMF10 + BCXMF01





CWM Contactors - Technical Data

Terminal Markings to EN 50012

Diagram	Distinctive number and version of combination	NO	NC	Reference code	Additional auxiliary contact blocks
Front mounting auxiliary contact blocks BCXMF10 or BCXMF01					
	22E	2	2	CWM9-10 CWM12-10 CWM18-10	+ 2 BCXMF01 + BCXMF10
	32E	3	2	CWM9-10 CWM12-10 CWM18-10	+ 2 BCXMF01 + 2 BCXMF10
	13E	1	3	CWM9-10 CWM12-10 CWM18-10	+ 3 BCXMF01
	23E	2	3	CWM9-10 CWM12-10 CWM18-10	+ 3 BCXMF01 + BCXMF10
Side mounting auxiliary contact blocks each with two contacts					
	11E	1	1	CWM25-00 to CWM105-00	+ BCXML11
	31E	3	1	CWM25-00 to CWM105-00	+ BCXML11 + BCXML20
	22E	2	2	CWM25-00 to CWM105-00	+ 1 BCXML11 + 1 BCXMR11
Without auxiliary contact blocks					
	-	0	0	CWM25-00 to CWM105-00	-
Front mounting auxiliary contact blocks BCXMF10 or BCXMF01					
	10E	1	0	CWM25-00 to CWM105-00	+ BCXMF10
	01E	0	1	CWM25-00 to CWM105-00	+ BCXMF01



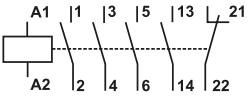
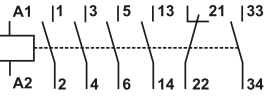
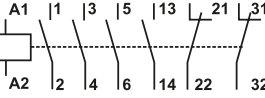
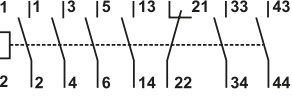
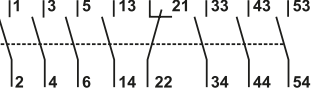
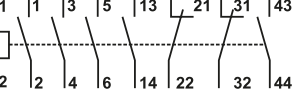
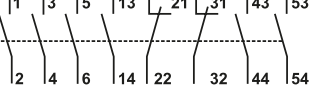
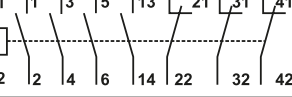
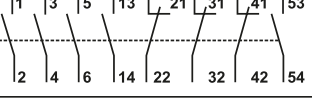

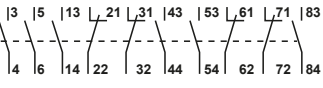
CWM Contactors - Technical Data

Terminal Markings to EN 50012

Diagram	Distinctive number and version of combination	NO	NC	Reference code	Additional auxiliary contact blocks
Front mounting auxiliary contact blocks BCXMF10 or BCXMF01					
	11E	1	1	CWM25-00 to CWM105-00	+ BCXMF10 + BCXMF01
	21E	2	1	CWM25-00 to CWM105-00	+ 2 BCXMF10 + BCXMF01
	12E	1	2	CWM25-00 to CWM105-00	+ BCXMF10 + 2 BCXMF01
	31E	3	1	CWM25-00 to CWM105-00	+ 3 BCXMF10 + BCXMF01
	41E	4	1	CWM50-00 to CWM105-00	+ 4 BCXMF10 + BCXMF01
	22E	2	2	CWM25-00 to CWM105-00	+ 2 BCXMF01 + 2 BCXMF10
	32E	3	2	CWM50-00 to CWM105-00	+ 2 BCXMF01 + 3 BCXMF10
	13E	1	3	CWM25-00 to CWM105-00	+ BCXMF10 + 3 BCXMF01
	23E	2	3	CWM50-00 to CWM105-00	+ 3 BCXMF01 + 2 BCXMF10
Contactors without auxiliary contact blocks + Side mounting auxiliary contact blocks each with two contacts					
	22	2	2	CWM112 to CWM800	+ 2 BCXML11
	44	4	4	CWM112 to CWM800	+ 2 BCXML11 + 2 BCXMR11

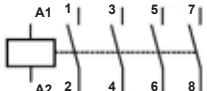
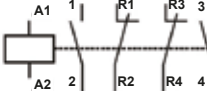
CWM Contactors - Technical Data

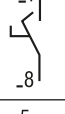
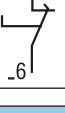
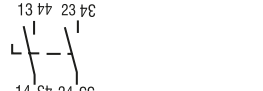
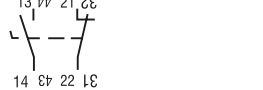
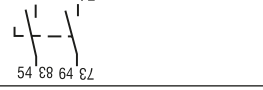
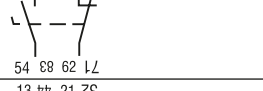
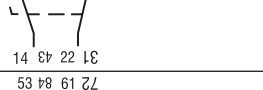
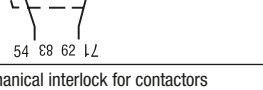
Terminal Markings to EN 50012

Diagram	Configuration	Power contacts		Reference code
		NO	NC	
4 pole contactors				
	-	4	0	CWM9-00-40♦ CWM12-00-40♦ CWM18-00-40♦
	-	2	2	CWM9-00-22♦ CWM12-00-22♦ CWM18-00-22♦
Diagram	Configuration	Auxiliary contacts		Reference code
		NO	NC	
Front mounting auxiliary contact blocks BCXMF10 or BCXMF01				
	10	1	0	BCXMF10
	01	0	1	BCXMF01
	10	1	0	BCXMF10
	01	0	1	BCXMF01
Diagram	Configuration	Auxiliary contacts		Reference code
		NO	NC	
Side mounting auxiliary contact blocks each with two contacts				
	20	2	0	BCXML20
	11	1	1	BCXML11
	20	2	0	BCXML20
	11	1	1	BCXML11
	11	1	1	BCXML11 CWM800
	11	1	1	BCXML11 CWM800
Electrical and mechanical interlock for contactors				
	02	0	2	BLIM.02

CWM Contactors - Technical Data

Electrical Lifespan

AC-3 ($U_e \leq 440 \text{ V ac}$)

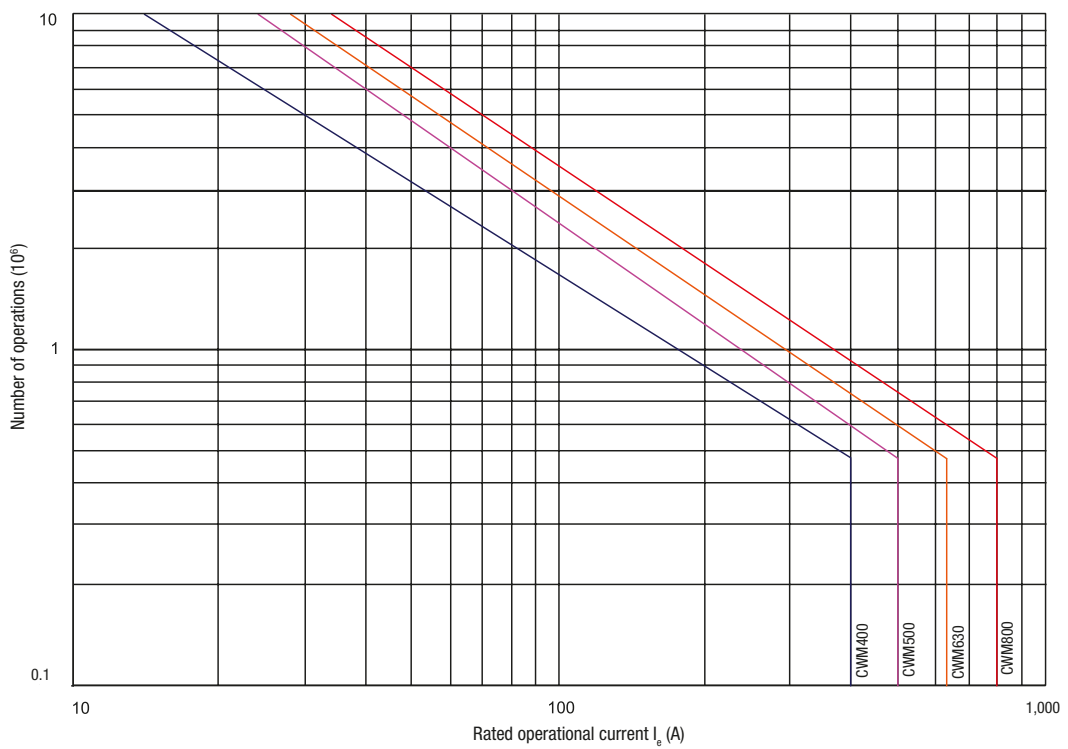
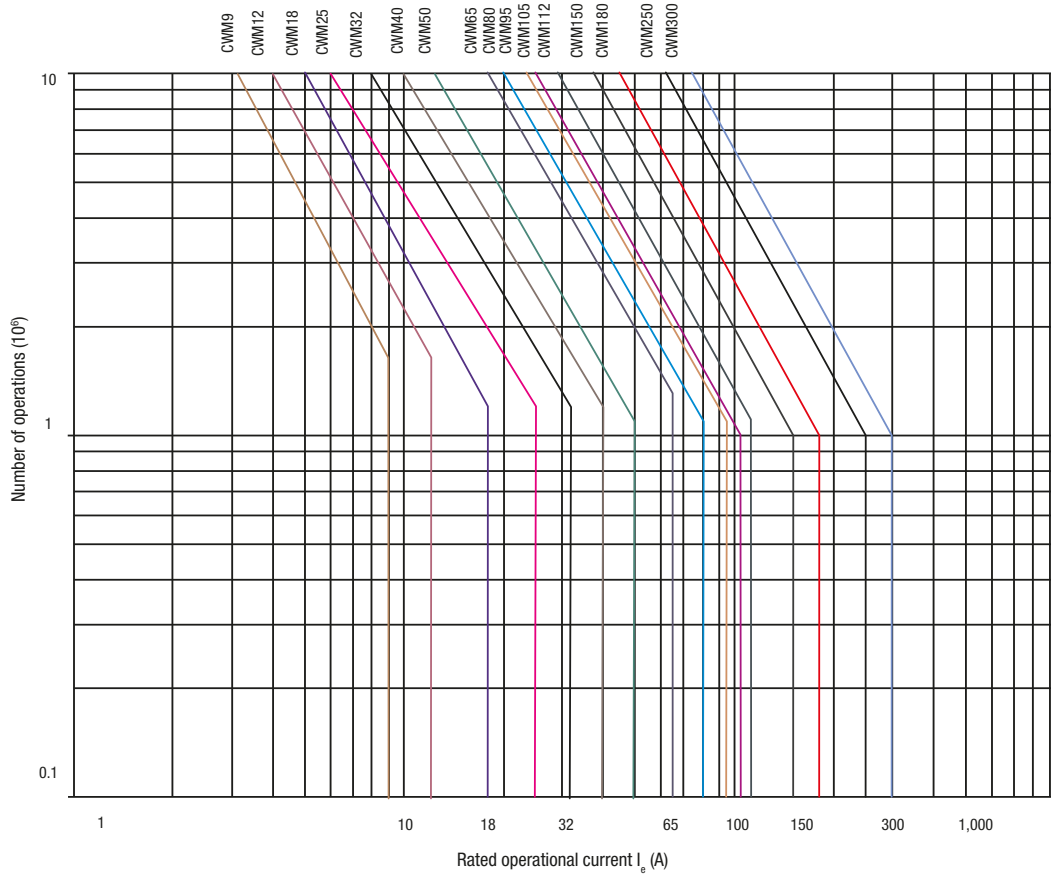

CWM Contactors - Technical Data

Electrical Lifespan

AC-4 ($U_e \leq 440 \text{ V ac}$)

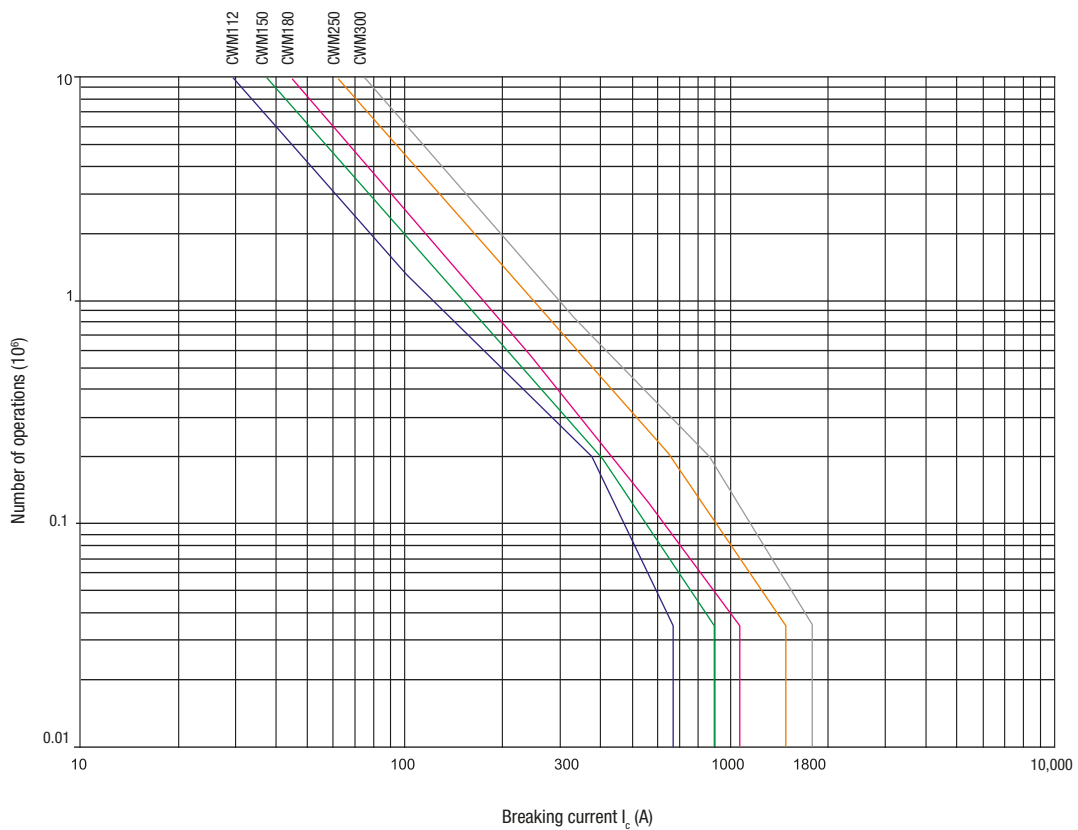
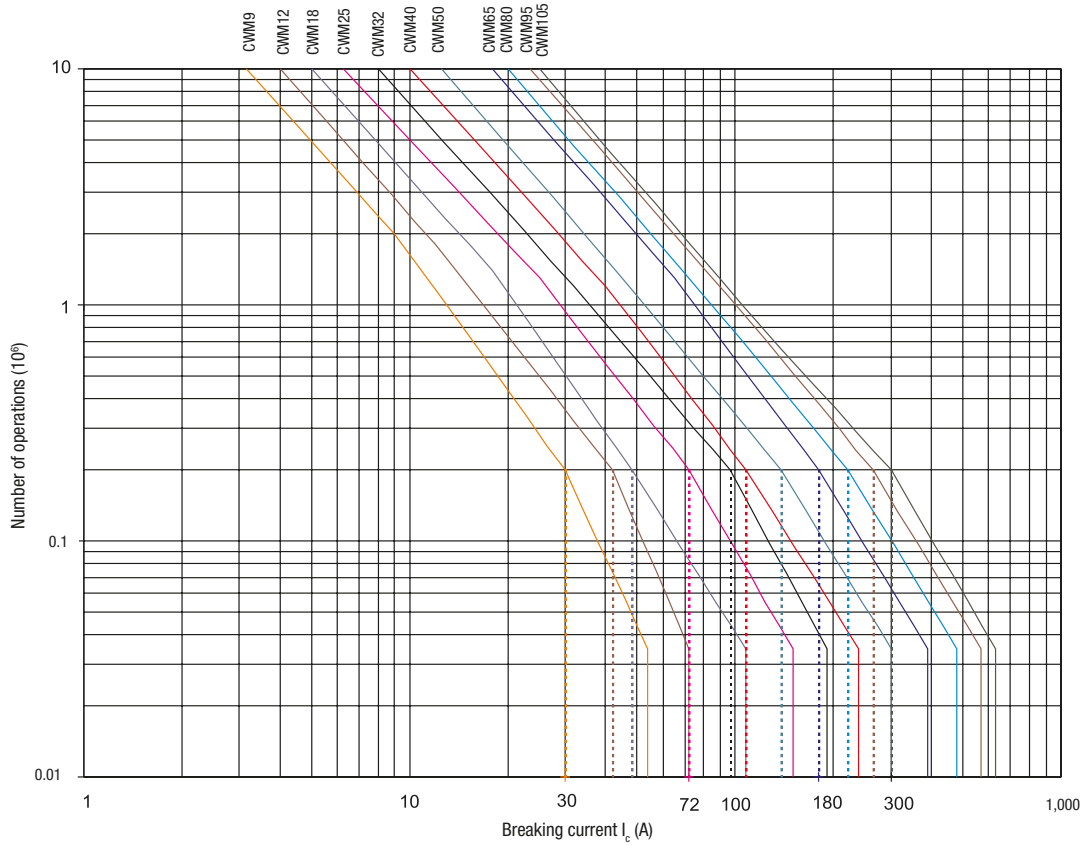

CWM Contactors - Technical Data

Electrical Lifespan

AC-4 ($U_e \leq 440 \text{ V ac}$)

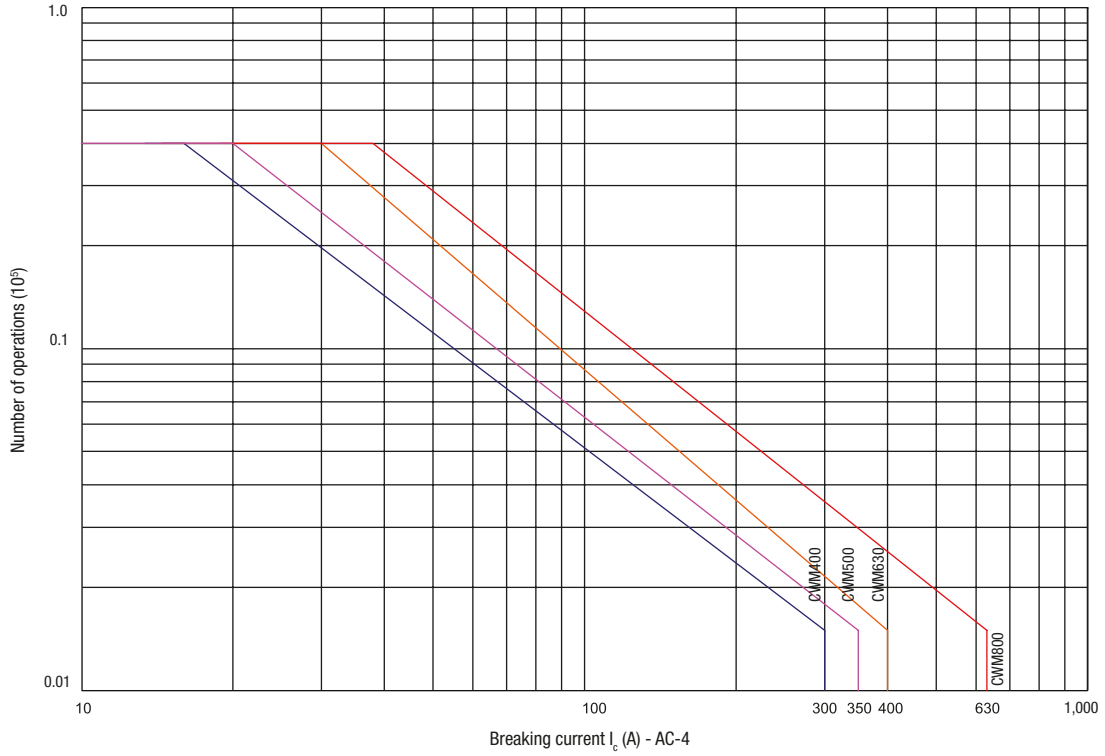

AC-1 ($U_e \leq 690 \text{ V ac}$)

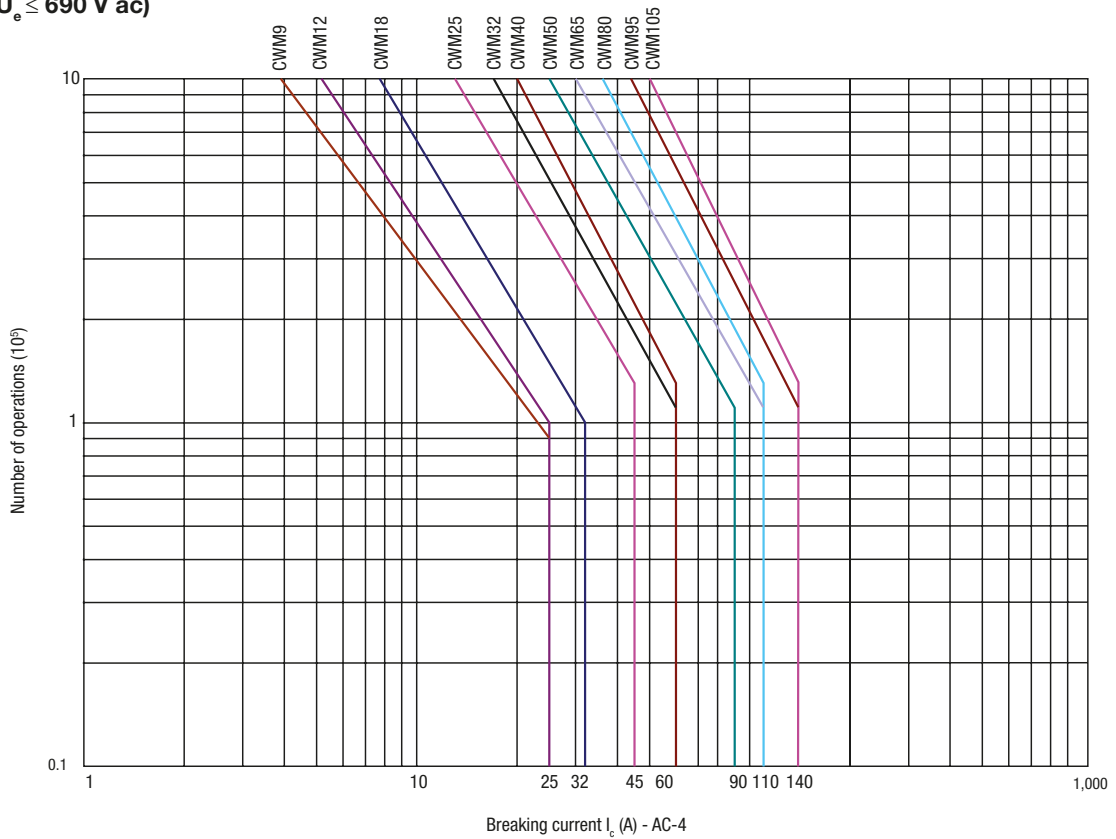

CWM Contactors - Technical Data

Electrical Lifespan

AC-1 ($U_e \leq 690 \text{ V ac}$)

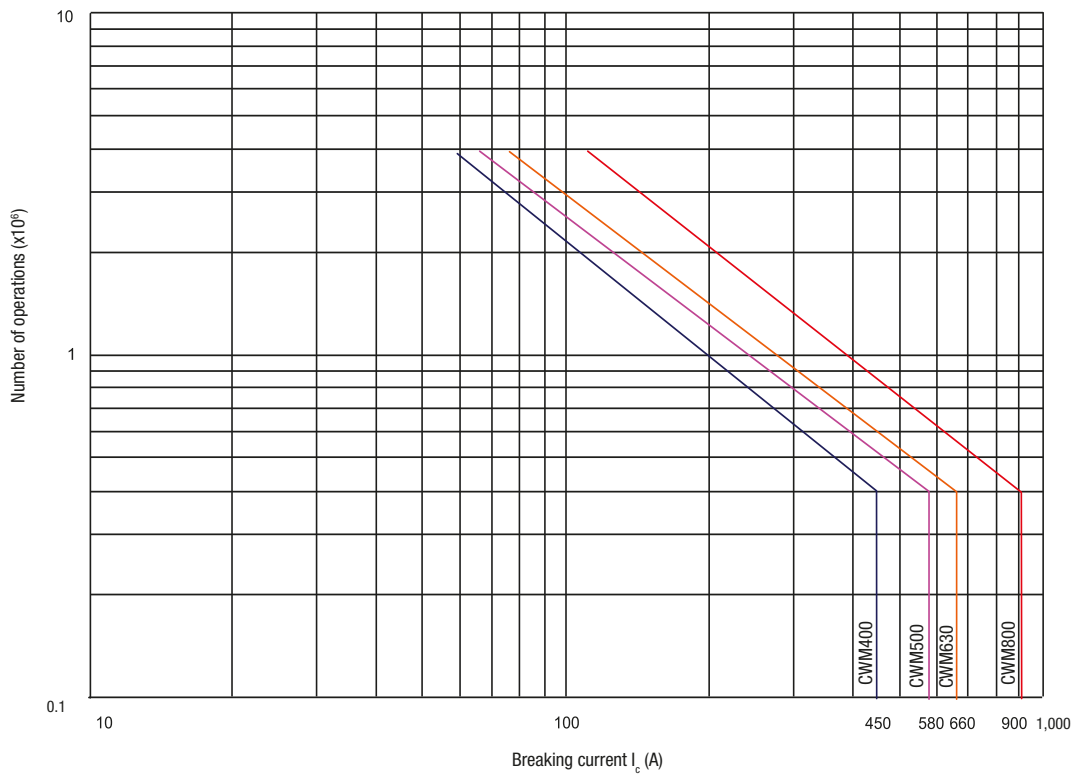
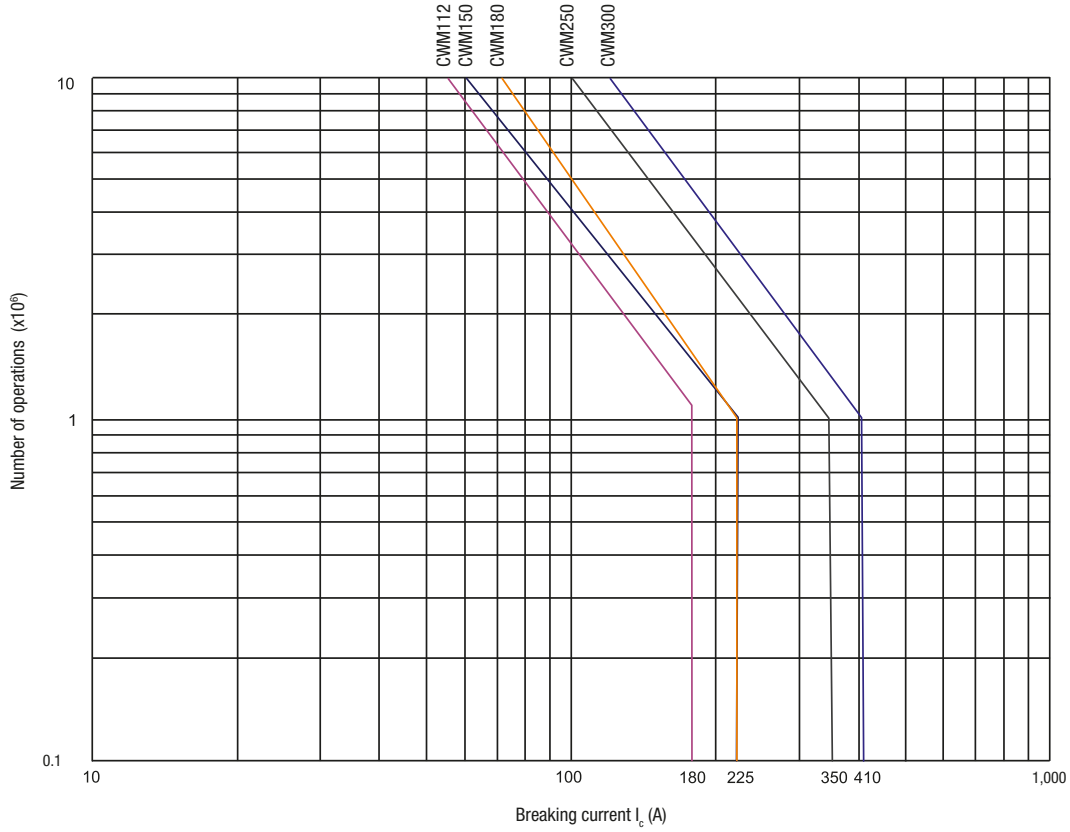

CWM Contactors - Dimensions (mm)

CWM9, CWM12 and CWM18

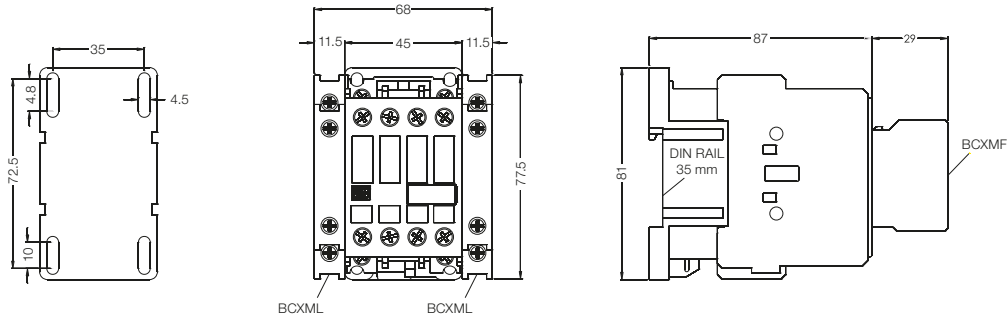

CWM25

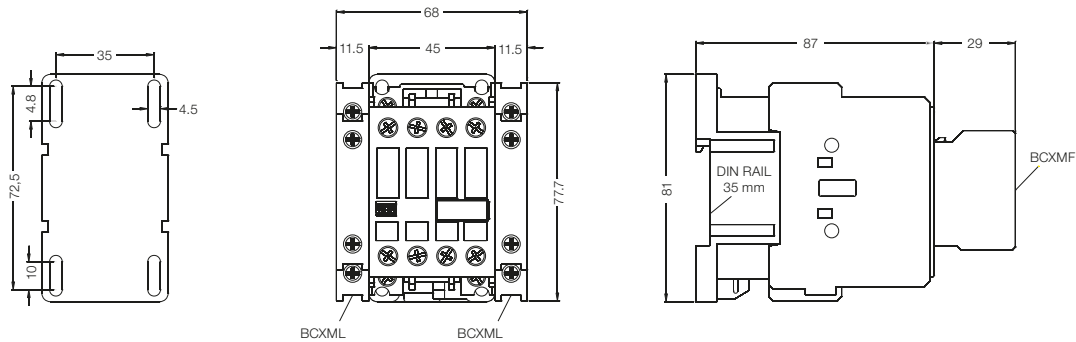

CWM32 and CWM40

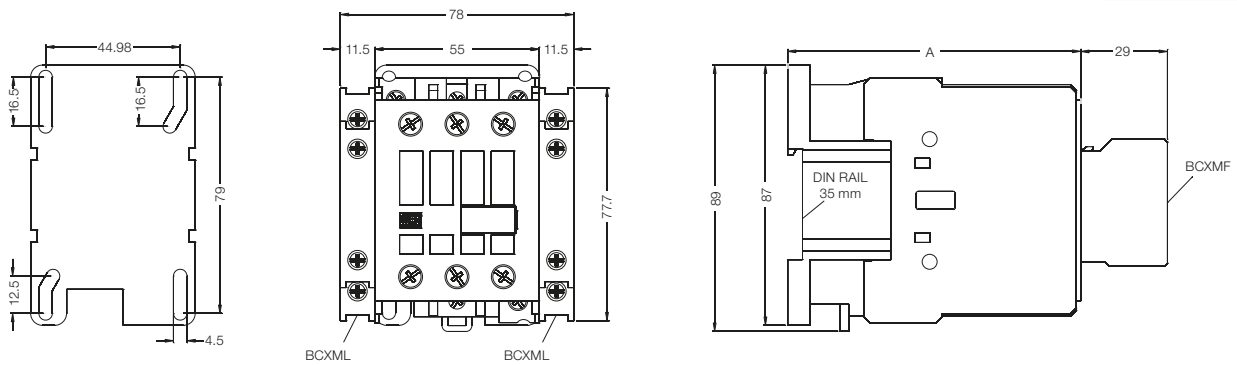

Coil	
AC	DC
A = 98	A = 118

CWM50, CWM65 and CWM80

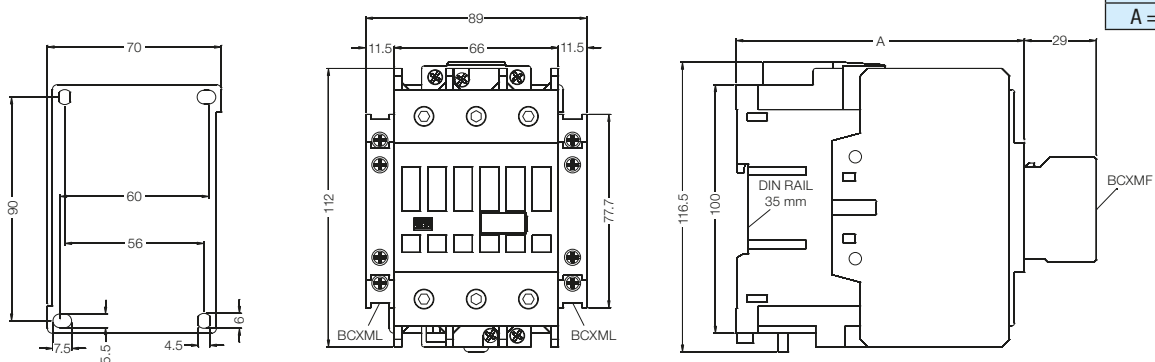

Coil	
AC	DC
A = 116	A = 116

CWM Contactors - Dimensions (mm)

CWM95 and CWM105

Coil	
AC	DC
A = 126	A = 126

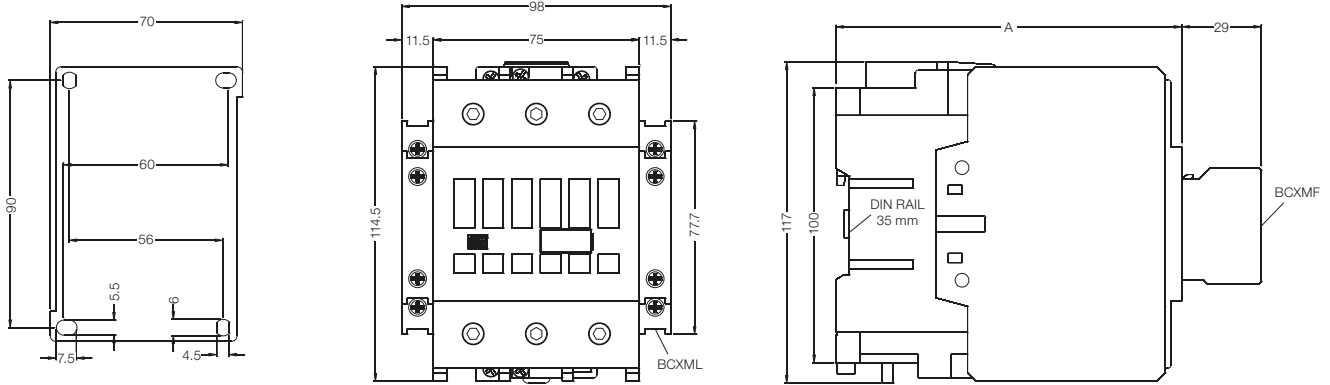

CWM112 and CWM150

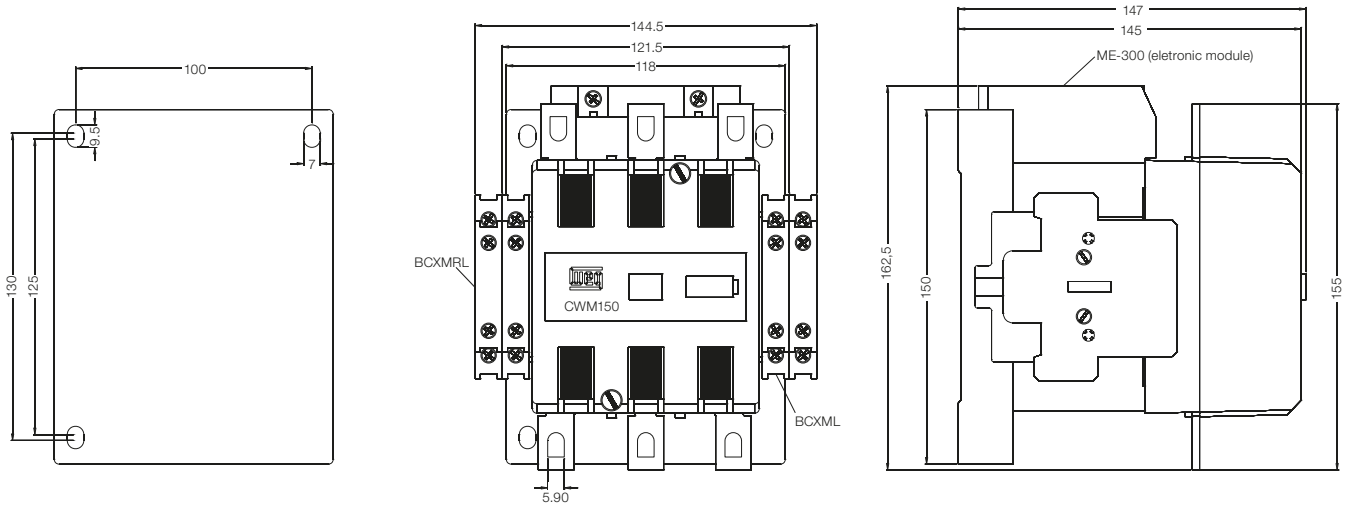

CWM180

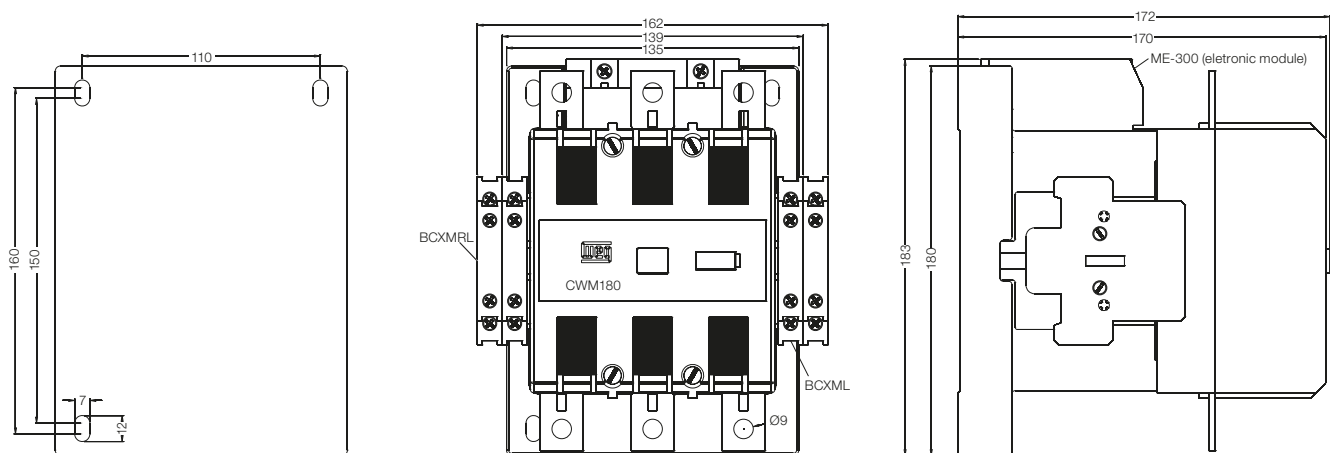

CWM Contactors - Dimensions (mm)

CWM250 and CWM300

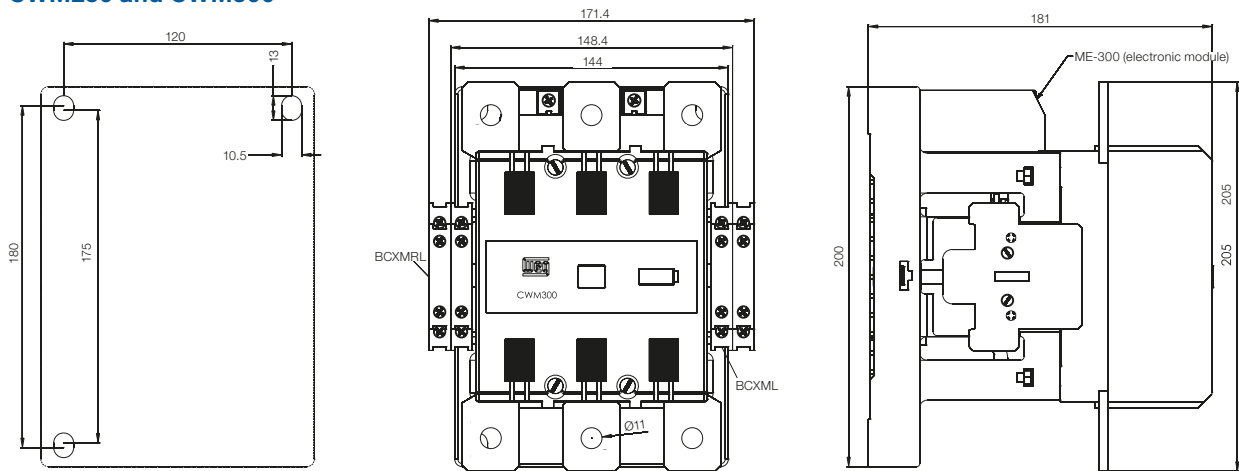

BLIM9-105 and BLIM.02

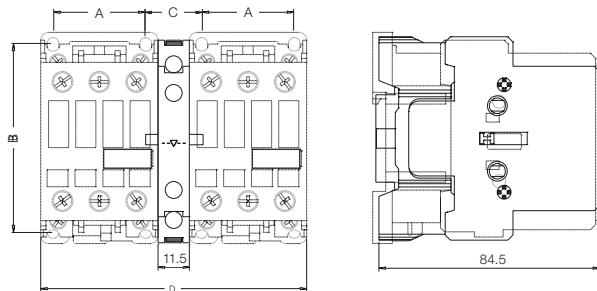

Models	A	B	C	D
CWM9...25	35	72.5	22	102
CWM32...40	45	79	22	122
CWM50...80	57	90	21	144
CWM95...105	57	90	29.8	153

BLIM112-300

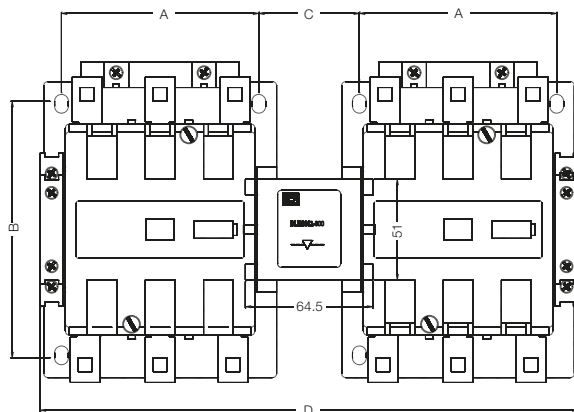

Models	A	B	C	D
CWM112...150	100	130	51	272.5
CWM180	110	160	58.5	303.5
CWM250...300	120	180	57	325.4

CWM Contactors - Dimensions (mm)

BMP CWM112...300

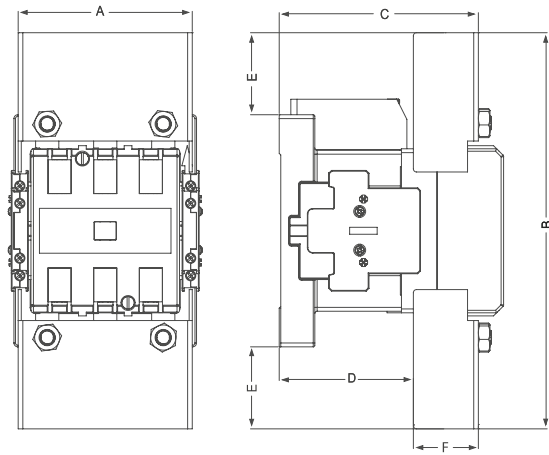

	BMP CWM150 + CWM112/150	BMP CWM180 + CWM180	BMP CWM300 + CWM250/300
A	112.5	127.5	148.5
B	256	290.4	320.8
C	128	137.7	146
D	86	90.7	84
E	53	55.2	60.5
F	42	47	62

TB... + CWM112...300

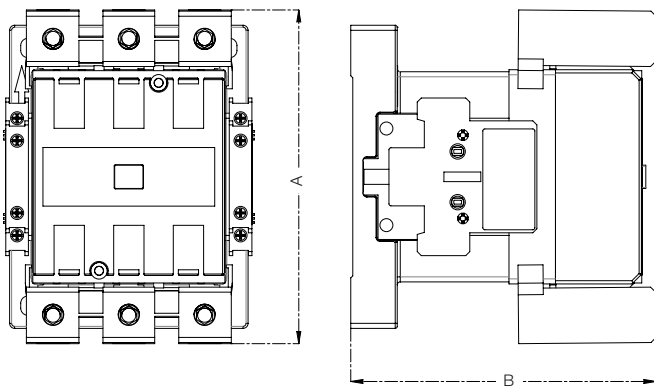

	TB150 + CWM112/150	TB180 + CWM180	TB300 + CWM250/300
A	167.6	190.3	218.6
B	151.1	176	193.8

Mounting Position

CWM9...105

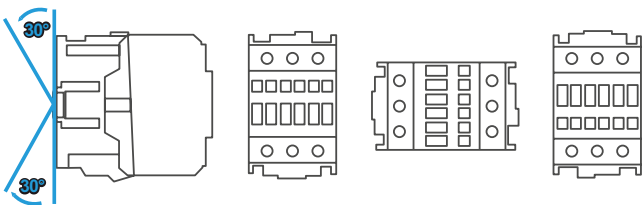

CWM112...300

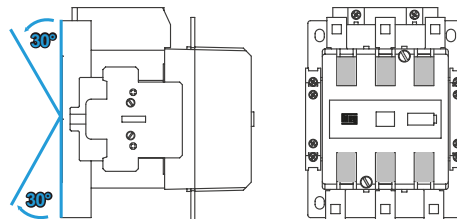

CWM Contactors - Dimensions (mm)

CWM400 - 3-Pole

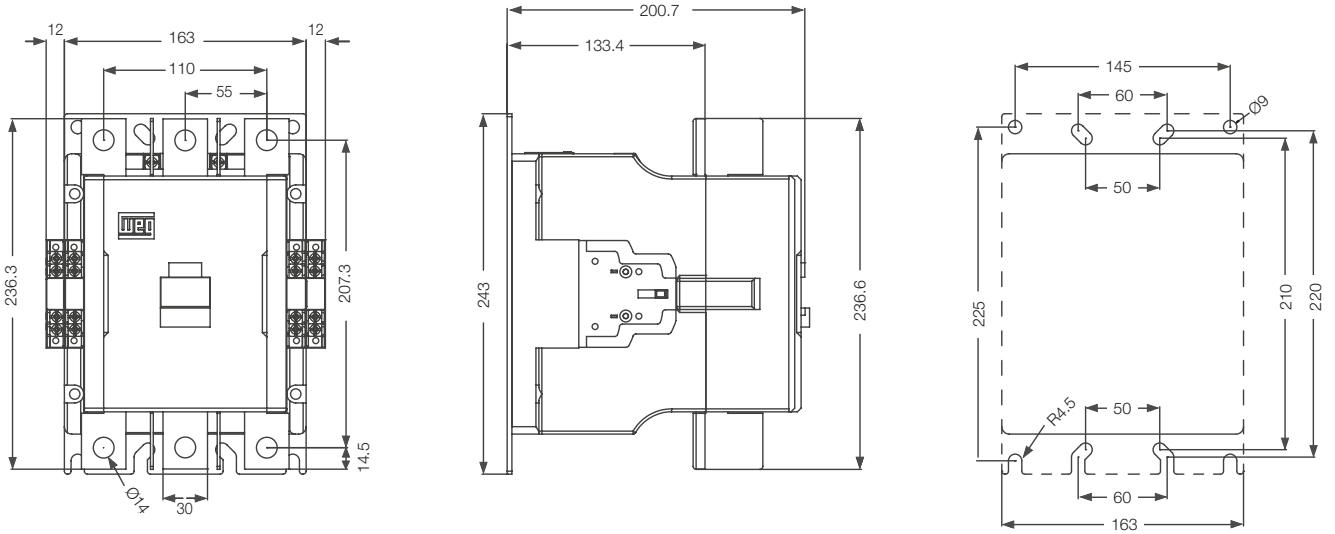

CWM400 - 4-Pole

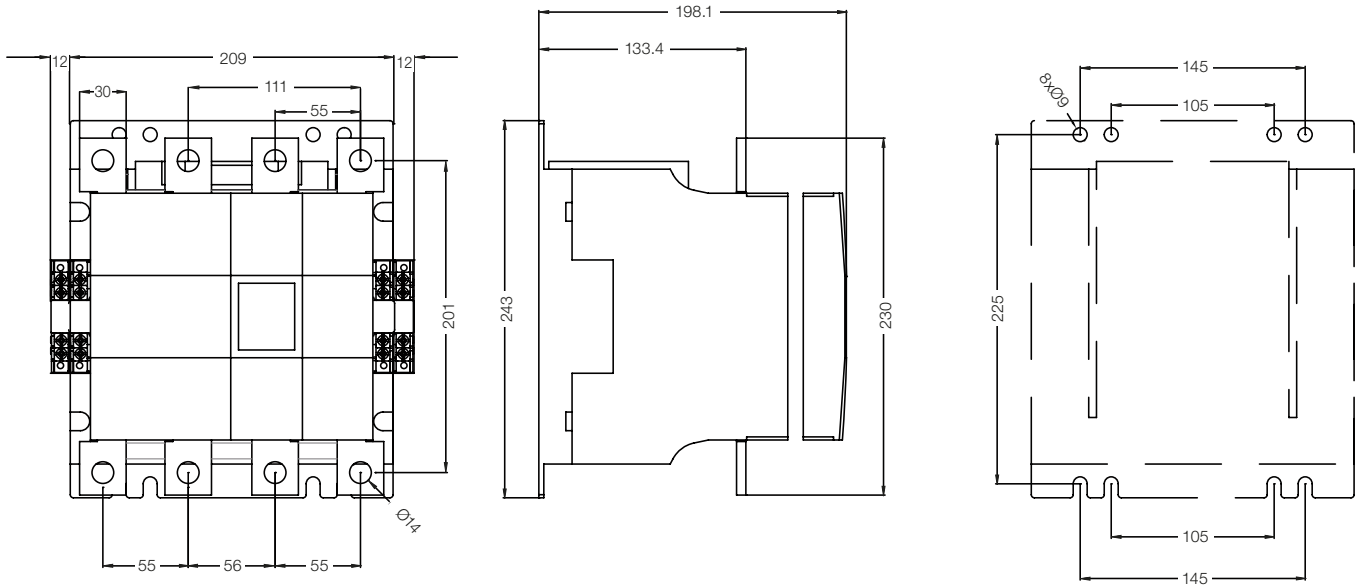

CWM Contactors - Dimensions (mm)

CWM500, CWM630 and CWM800 - 3-Pole

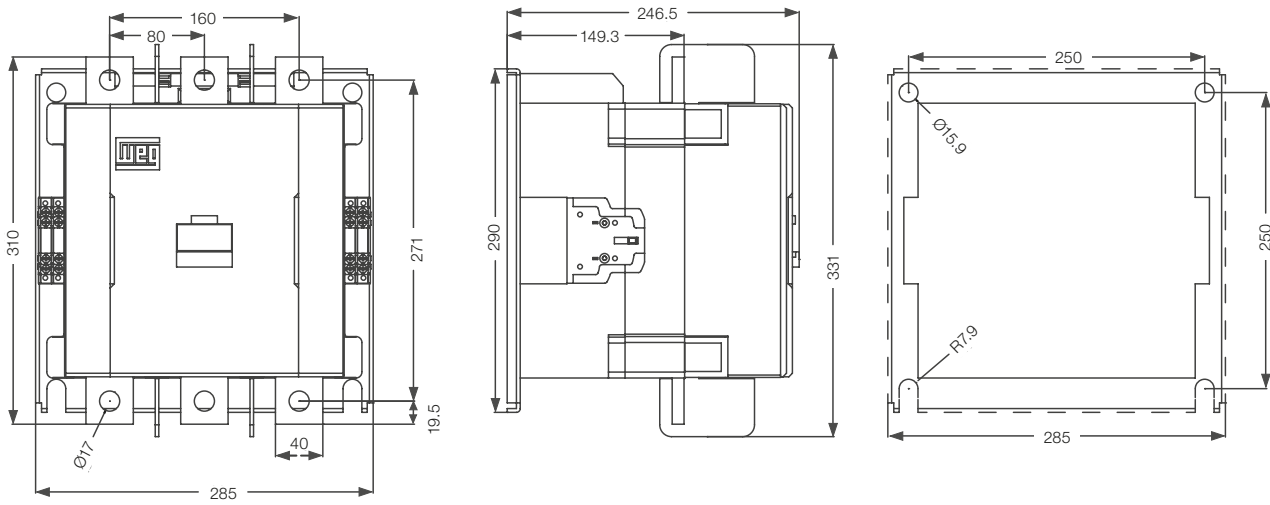

CWM500, CWM630 and CWM800 - 4-Pole

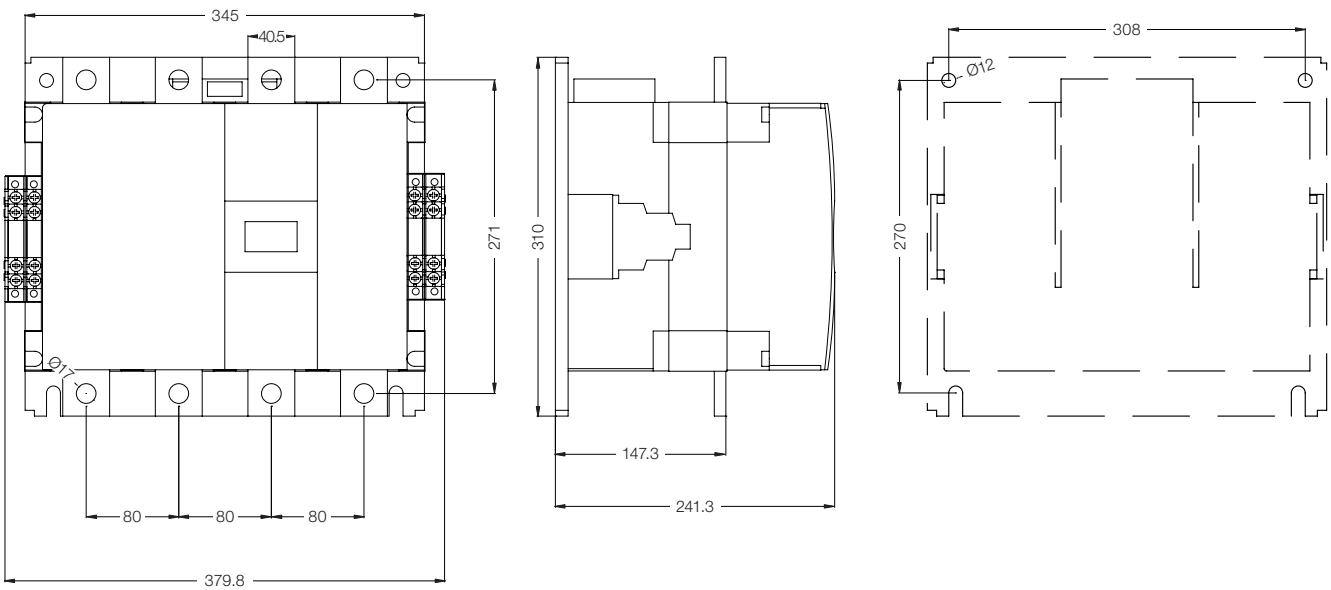

CWM Contactors - Dimensions (mm)

BLIM CWM400

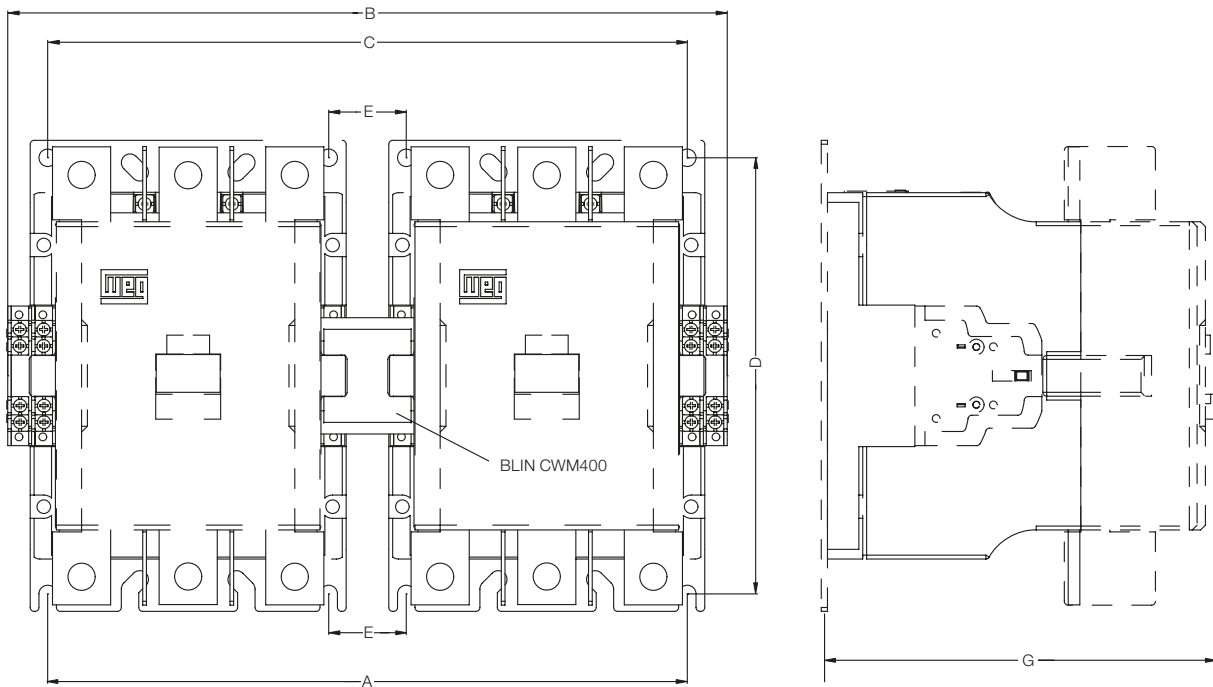

BLIM CWM800

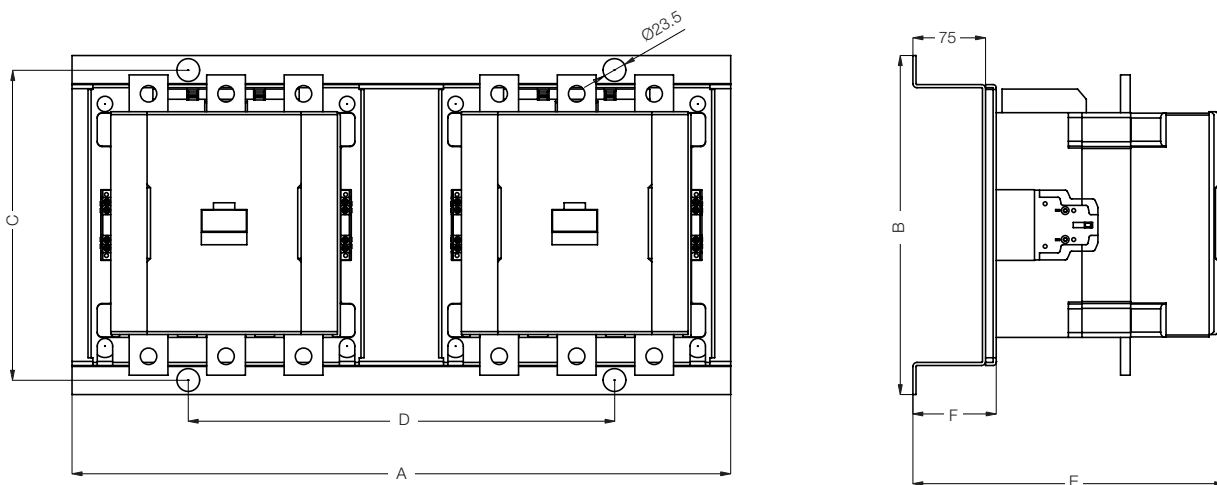

	BLIM CWM400 + CWM400	
	3-pole	4-pole
A	330	375
B	371.2	464
C	330	375
D	225	225
E	40	85
F	40	85
G	203.9	198.2

	BLIM CWM800 + CWM500...800	
	3-pole	4-pole
A	680	740
B	351	370
C	321	340
D	440	440
E	321	316.3
F	86	86
G	75	75

CWM Contactors - Dimensions (mm)

BMP CWM400...800

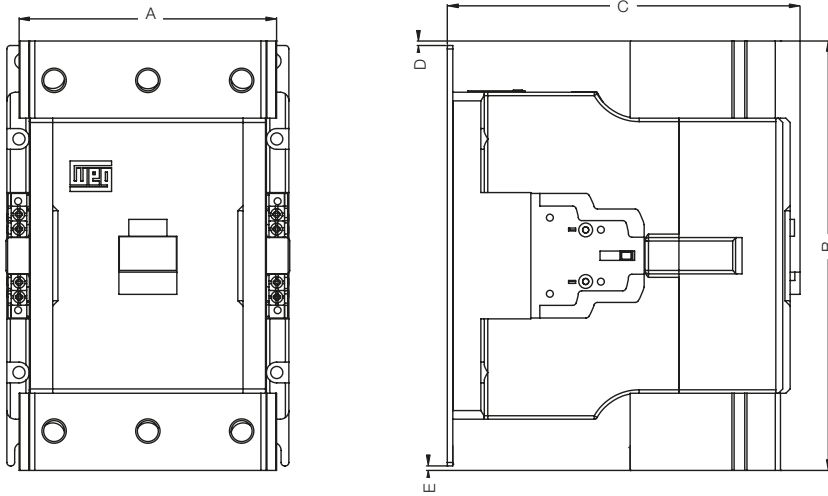

	BMP CWM400 + CWM400		BMP CWM800 + CWM500...800	
	3-pole	4-pole	3-pole	4-pole
A	148.8	214	234	314
B	248.2	250.8	320.2	350.5
C	200.7	198.2	246.5	241.3
D	2.6	1.76	111.6	20.25
E	2.6	7.76	15.1	20.25

BMJ CWM400...800

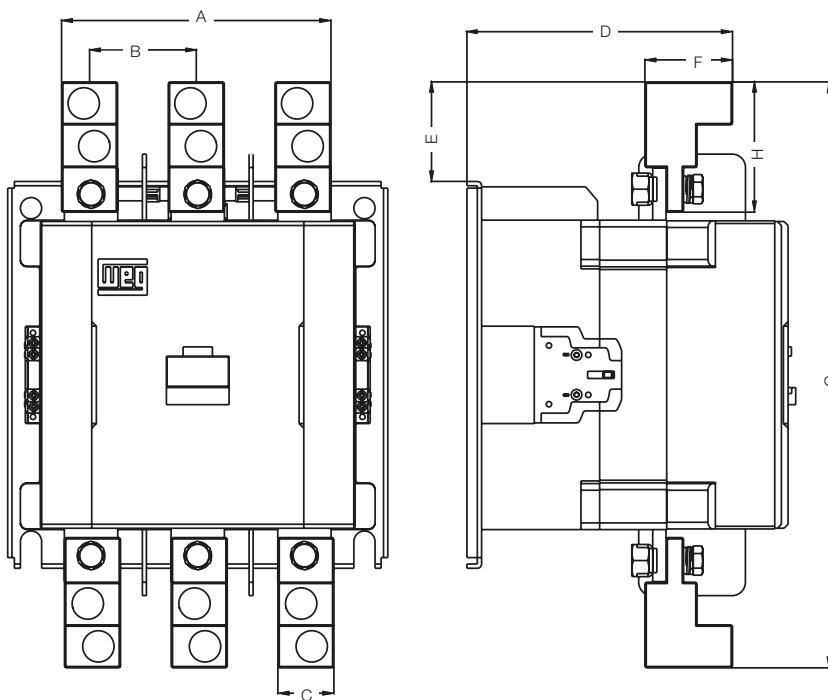

	BMJ CWM400 + CWM400	BMJ CWM800 + CWM500...800
	A	140.2
B	55	80
C	30.2	42
D	187.4	199.15
E	53.6	74.65
F	59.5	65.7
G	350.2	439.3

Mounting Position

CWM400...800

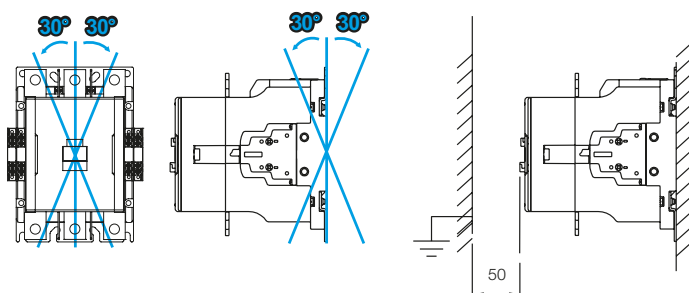

Global presence is essential, as much as understanding your needs.

Global Presence

With more than 30.000 employees worldwide, WEG is one of the largest electric motors, electronic equipments and systems manufacturers. We are constantly expanding our portfolio of products and services with expertise and market knowledge. We create integrated and customized solutions ranging from innovative products to complete after-sales service.

WEG's know-how guarantees our **Contactors - CWM Line** is the right choice for your application and business, assuring safety, efficiency and reliability.



Availability is to have a global support network



Partnership is to create solutions that suits your needs



Competitive edge is to unite technology and innovation

Know More

High performance and reliable products to improve your production process.

Excellence is to provide a whole solution in industrial automation that improves our customers productivity.



Visit:

www.weg.net



youtube.com/wegvideos

WEG Worldwide Operations

ARGENTINA

San Francisco - Cordoba
Phone: +54 3564 421484
info-ar@weg.net

Cordoba - Cordoba
Phone: +54 351 4641366
weg-morbe@weg.com.ar

Buenos Aires
Phone: +54 11 42998000
ventas@pulverlux.com.ar

AUSTRALIA

Scoresby - Victoria
Phone: +61 3 97654600
info-au@weg.net

AUSTRIA

Markt Piesting - Wiener
Neustadt-Land
Phone: +43 2633 4040
watt@wattdrive.com

BELGIUM

Nivelles - Belgium
Phone: +32 67 888420
info-be@weg.net

BRAZIL

Jaraguá do Sul - Santa Catarina
Phone: +55 47 32764000
info-br@weg.net

CHILE

La Reina - Santiago
Phone: +56 2 27848900
info-cl@weg.net

CHINA

Nantong - Jiangsu
Phone: +86 513 85989333
info-cn@weg.net

Changzhou - Jiangsu
Phone: +86 519 88067692
info-cn@weg.net

COLOMBIA

San Cayetano - Bogota
Phone: +57 1 4160166
info-co@weg.net

ECUADOR

El Batan - Quito
Phone: +593 2 5144339
ceccato@weg.net

FRANCE

Saint-Quentin-Fallavier - Isère
Phone: +33 4 74991135
info-fr@weg.net

GERMANY

Türnich - Kerpen
Phone: +49 2237 92910
info-de@weg.net

Balingen - Baden-Württemberg
Phone: +49 7433 90410
info@weg-antriebe.de

Homberg (Efze) - Hesse
Phone: +49 5681 99520
info@akh-antriebstechnik.de

GHANA

Accra
Phone: +233 30 2766490
info@zestghana.com.gh

INDIA

Bangalore - Karnataka
Phone: +91 80 41282007
info-in@weg.net

Hosur - Tamil Nadu
Phone: +91 4344 301577
info-in@weg.net

ITALY

Cinisello Balsamo - Milano
Phone: +39 2 61293535
info-it@weg.net

JAPAN

Yokohama - Kanagawa
Phone: +81 45 5503030
info-jp@weg.net

MALAYSIA

Shah Alam - Selangor
Phone: +60 3 78591626
info@wattdrive.com.my

MEXICO

Huehuetoca - Mexico
Phone: +52 55 53214275
info-mx@weg.net

Tizayuca - Hidalgo
Phone: +52 77 97963790

NETHERLANDS

Oldenzaal - Overijssel
Phone: +31 541 571080
info-nl@weg.net

PERU

La Victoria - Lima
Phone: +51 1 2097600
info-pe@weg.net

PORTUGAL

Maia - Porto
Phone: +351 22 9477700
info-pt@weg.net

RUSSIA and CIS

Saint Petersburg
Phone: +7 812 363 2172
sales-wes@weg.net

SOUTH AFRICA

Johannesburg
Phone: +27 11 7236000
info@zest.co.za

SPAIN

Coslada - Madrid
Phone: +34 91 6553008
wegiberia@wegiberia.es

SINGAPORE

Singapore
Phone: +65 68589081
info-sg@weg.net

Singapore
Phone: +65 68622220
watteuro@watteuro.com.sg

SCANDINAVIA

Mölnlycke - Sweden
Phone: +46 31 888000
info-se@weg.net

UK

Redditch - Worcestershire
Phone: +44 1527 513800
info-uk@weg.net

UNITED ARAB EMIRATES

Jebel Ali - Dubai
Phone: +971 4 8130800
info-ae@weg.net

USA

Duluth - Georgia
Phone: +1 678 2492000
info-us@weg.net

Minneapolis - Minnesota
Phone: +1 612 3788000

VENEZUELA

Valencia - Carabobo
Phone: +58 241 8210582
info-ve@weg.net

For those countries where there is not a WEG own operation, find our local distributor at www.weg.net.



WEG Group - Automation Business Unit
Jaraguá do Sul - SC - Brazil
Phone: +55 47 3276 4000
automacao@weg.net
www.weg.net

