

Motor Protective Circuit Breaker

Operation and Protection of Motors Up to 100 A

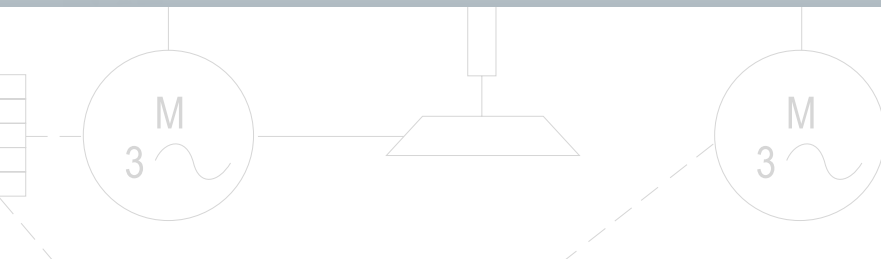

CLASS 10

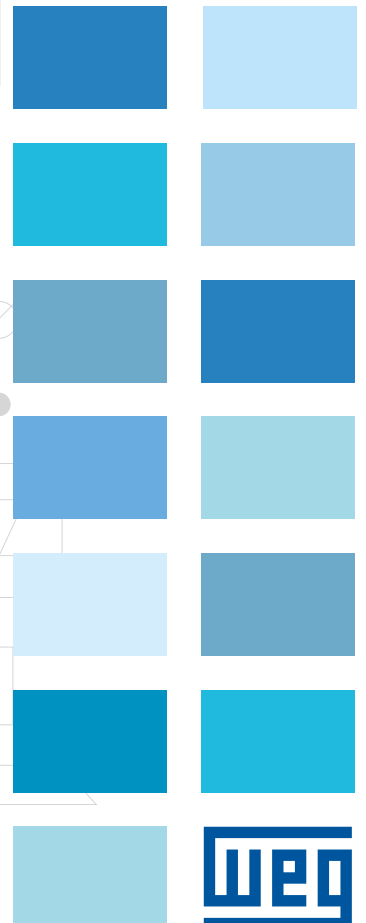
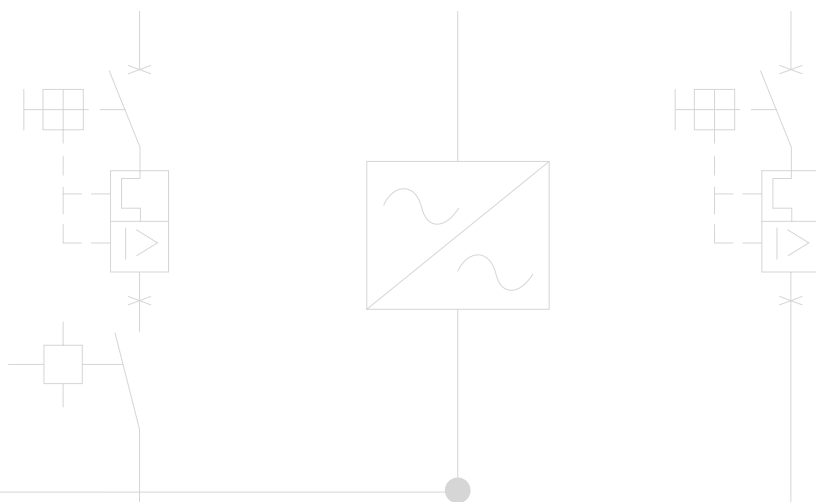

V1A

MPW40



36

40

TRIP

L
ON

TEST
520 A

36

32

TEST
520 A

OFF

TEST

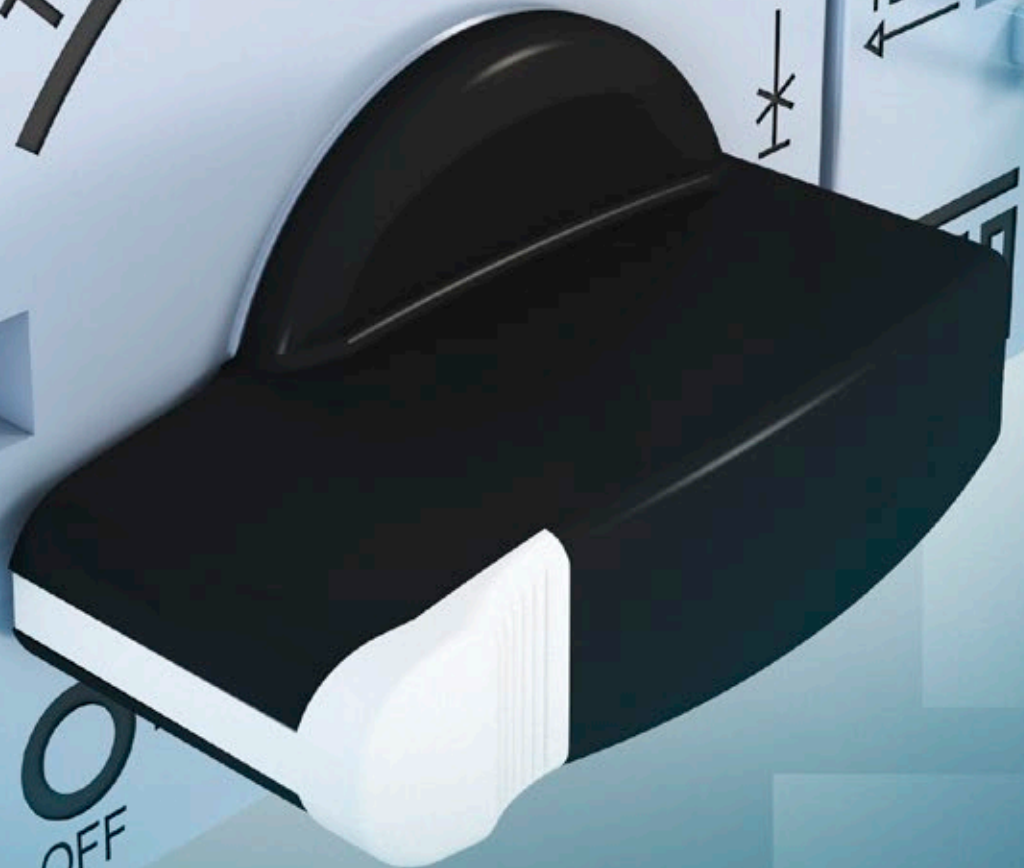

Motor Protective Circuit Breakers MPW

Summary

Presentation	04
MPW12 Motor Protective Circuit Breaker up to 12 A - Overview and Selection Table	
Thermomagnetic or Magnetic Only - Spring Terminal.....	12
MPW18 Motor Protective Circuit Breaker up to 18 A - Overview and Selection Table	
Thermomagnetic or Magnetic Only - Screen Terminal.....	14
MPW40 Motor Protective Circuit Breaker up to 40 A - Overview and Selection Table	
Thermomagnetic or Magnetic Only - Screen Terminal.....	16
MPW80 Motor Protective Circuit Breaker up to 80 A - Overview and Selection Table	
Thermomagnetic or Magnetic Only - Screen Terminal.....	18
MPW100 Motor Protective Circuit Breaker up to 100 A - Overview and Selection Table	
Thermomagnetic - Screen Terminal.....	19
MPW40t (1m = 19x In) Motor Protective Circuit Breaker up to 20 A - Selection Table	
Thermomagnetic - Screen Terminal.....	20
Accessories	21
Technical Data	28
Diagrams and Typical Circuits	37
Dimensions	38

The best solution for **Switching** and **Protecting** your **electric motor**.



MPW Motor-Protective Circuit Breakers

Developed according to IEC 60947 and UL 508, the MPW line of motor-protective circuit breakers offers superior performance and high short-circuit breaking capacity for your applications.

High Short-Circuit Capacity (@380 V)

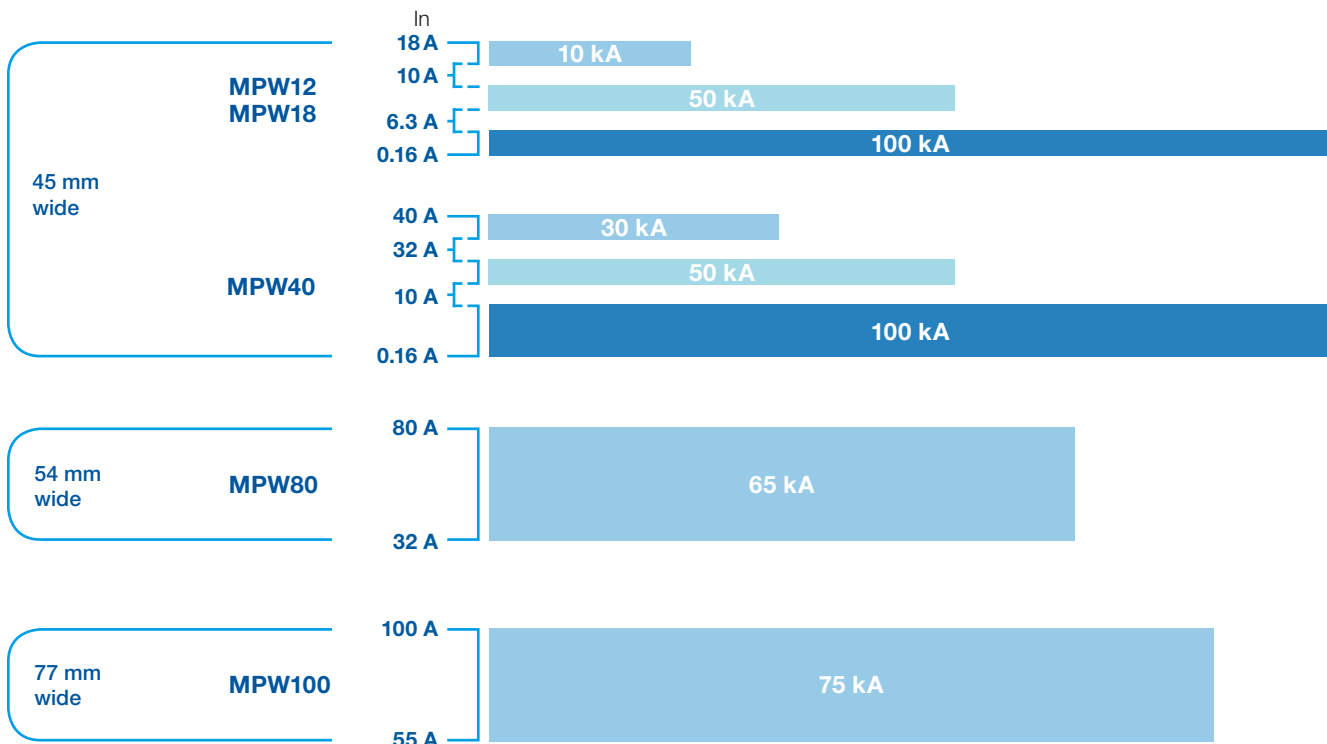



They perform the switching and protect against overloads and short-circuits, and their trip attachments may be calibrated up to nineteen times the maximum rated current of the circuit breaker.

- ✓ High durability: up to 100,000 operation cycles
- ✓ Wide range of interchangeable accessories
- ✓ Versions with pushbuttons or rotary knob, screw and spring terminals
- ✓ Compact combined starter sets (direct on-line, reversing and delta-star) with the CWB9...38 contactors and CWC07...25 minicontactors
- ✓ Sensitive to phase loss according to IEC 60947-4-1
- ✓ Function of molded-case circuit breaker/ fuse and overload relay in a single product

Main Certifications



MPW Motor-Protective Circuit Breaker

Three Functions in a Single Product!

Its main function is the protection against short-circuits and overloads in electric motor applications. In addition, they allow switching operations (15 operations/hour) directly with their handle or buttons.

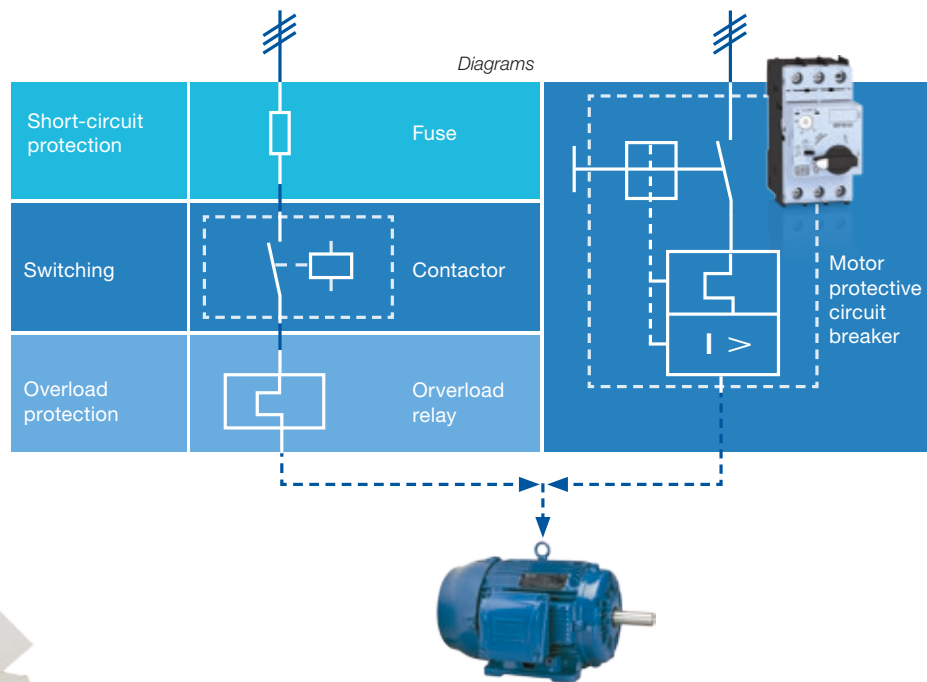

Handles for Thermography

The models of MRX handles coupled to the circuit breaker allow to open panels even with the handle in the ON position. This kind of function is commonly used on electrical panels where a thermographic analysis is necessary in preventive maintenance events. As default, this function comes disabled from the factory.

Position and State Indication

Front identification of the operating status of the circuit breaker by means of its rotary handle (MPW40...100) or key (MPW18). On the motor-protective circuit breakers with rotary drive, it is possible, by means of their handle, to indicate the TRIP, and which determines the position indication of the switching devices of electrical circuits.

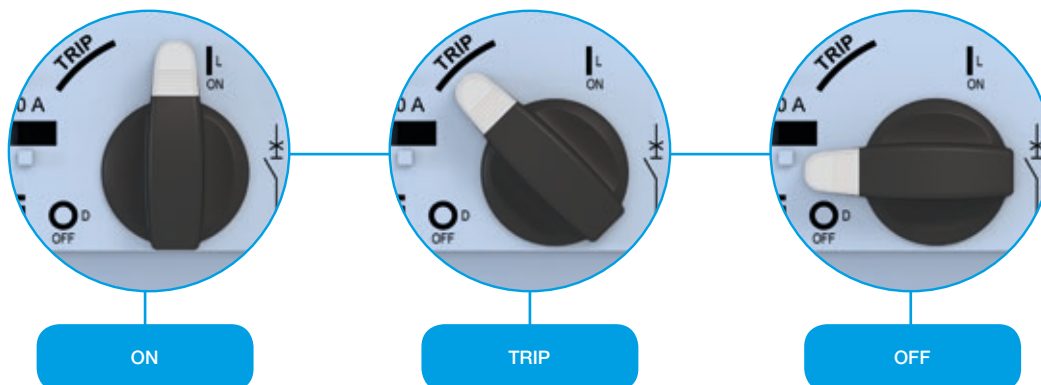

MPW Motor-Protective Circuit Breaker

Lock out, Isolation and Main Switch

All the MPW circuit breakers can be locked by means of seals or padlocks installed on the handle or front button, ensuring greater safety in stoppages for maintenance of panels and electric motors. In addition to this function, the circuit breakers comply with the isolation conditions of IEC 60947-3 and IEC 60947-2, that is, they may be used as an isolation device of electrical parts of a panel. They can also be used as main switches and emergency stop according to IEC 60204-1.

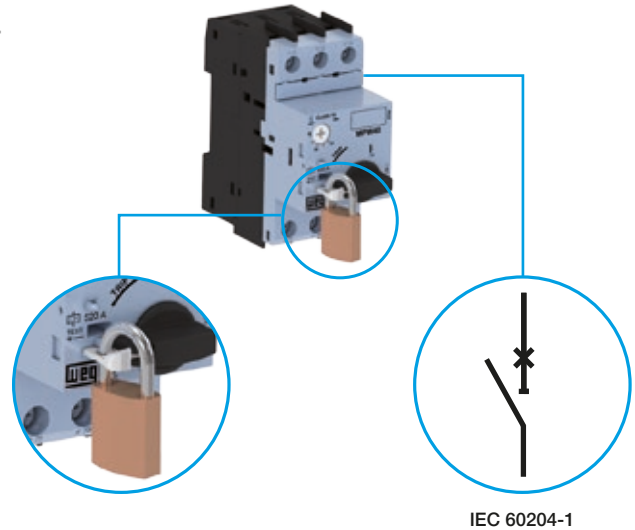

Connectors and Busbars

Connection busbars (easy connection) developed to save time and avoid assembly errors by panel installers and original equipment manufacturers (OEMs).

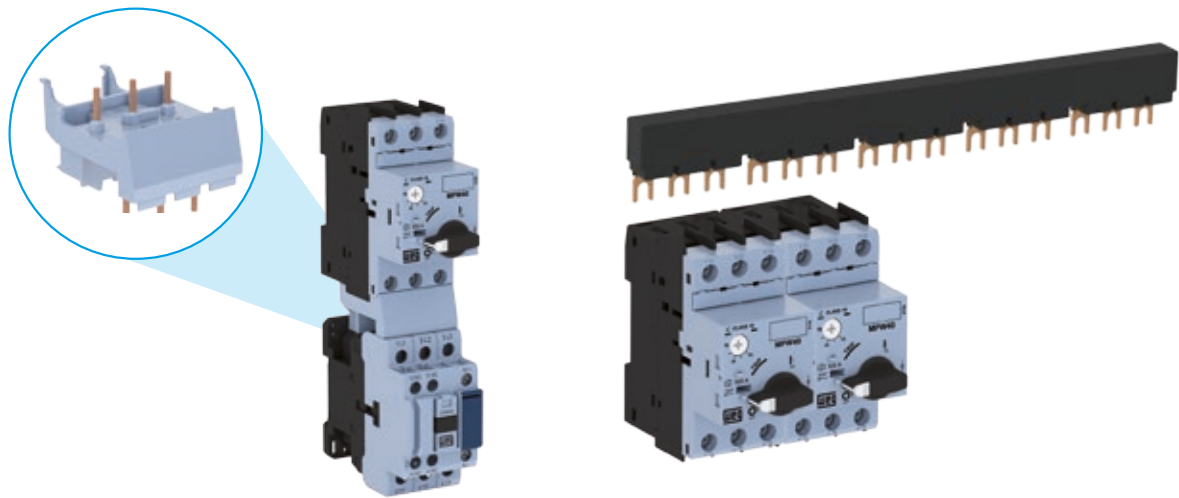

TSB Block for Trip Indication

The TSB accessory installed on the circuit breakers allow to signal the trip occurred by means of auxiliary contacts or mechanical indicators on this accessory.

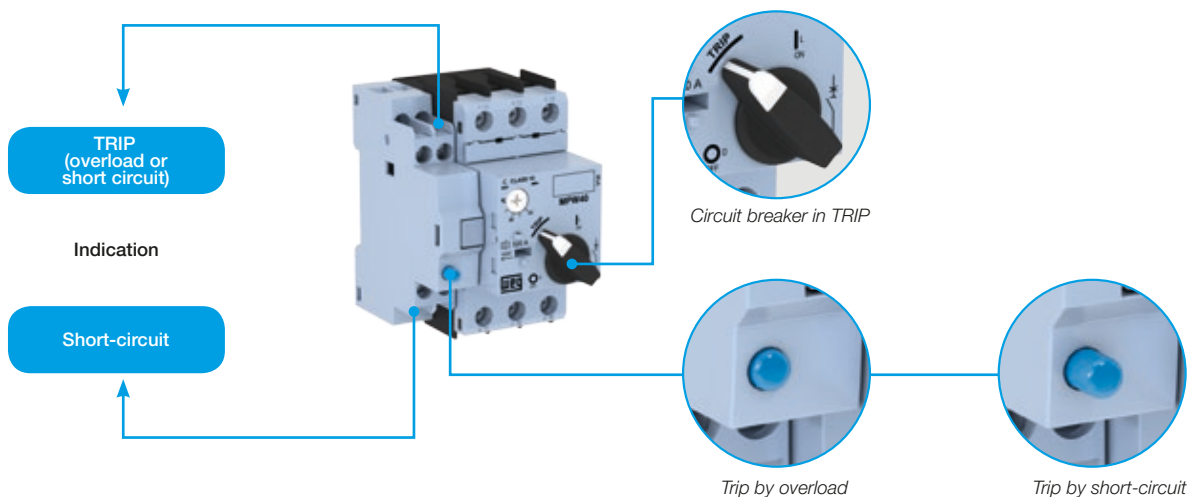

Note: using the TSB accessory, it is possible to use only one of the auxiliary contacts, the front (ACBF) or side (ACBS) contact.

MPW Motor-Protective Circuit Breaker

Handles for External Drive

Additional handles, installed on the MPW circuit breakers, allow external drive of the circuit breakers on panels, ensuring safe operations and full isolation of the live parts from the users. Versions available with degree of protection IP55, IP65 and Nema 4X (UL), in yellow/red and grey/black.

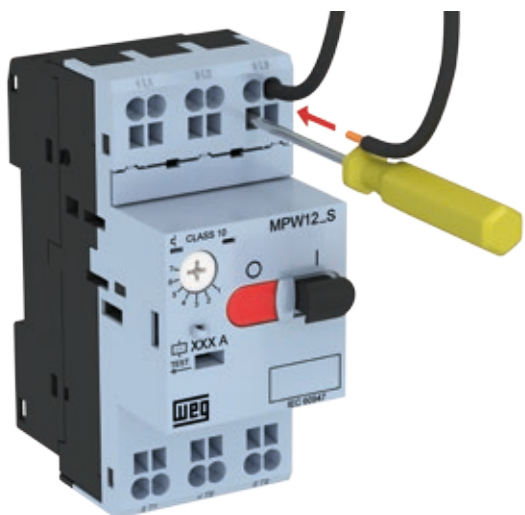
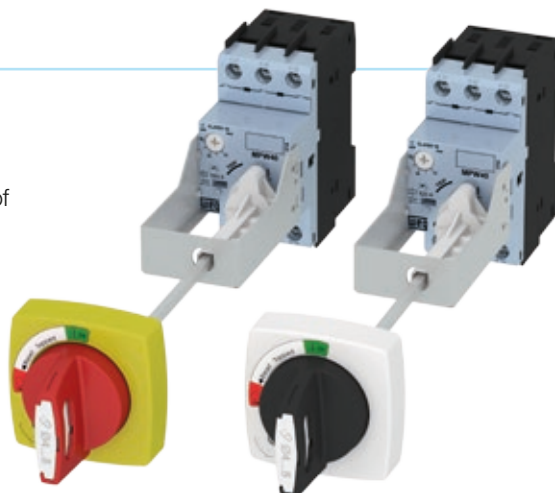

Faster and Securer Connection

The cage clamp connections of the MPW12 motor-protective circuit breakers provide faster installation of power cables and accessories. With a screwdriver suitable for the fitting, it is possible to make the connections in a shorter time in comparison to screw terminals. Due to special springs on the connection terminals, retightening is not necessary, because the connection system ensures constant pressure on the cables.

Protection of the Current Setting Dial

It allows to lock the current setting dial on the thermomagnetic circuit breakers. By using a seal together with this accessory, it is possible to ensure the reliability of the current setting on the circuit breakers installed in the field on electrical panels and machines. Supplied as accessory on the MPW12...80 circuit breakers and as standard on the MPW100 circuit breakers.

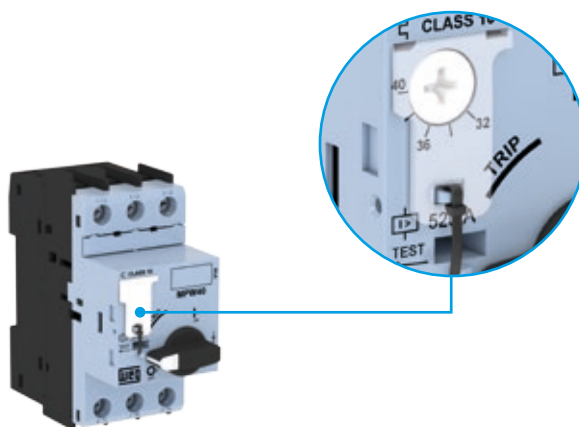

Insulated Enclosures Boxes

In applications with a reduced number of starts (15 starts/hour), it is possible to use surface-mount boxes IP41/IP66 for MPW12 and MPW18, and IP55 for boxes with MPW40, with direct drive on the circuit breakers very close to the electric motor. The rotary handle of the surface-mount boxes enables the lock out with up to three padlocks. On the surface-mount boxes for models MPW12 and MPW18, versions with keyed emergency pushbuttons enable the lock out of their operation. ACBS, ACBF, URMP/SRMP are accessories that can be installed within the box.

MPW Motor-Protective Circuit Breaker

Interchangeable Accessories

All the main accessories are interchangeable among the models MPW18...80, allowing the optimization of items and greater flexibility of their applications. Example: the front contact block can be installed on up to three different models.

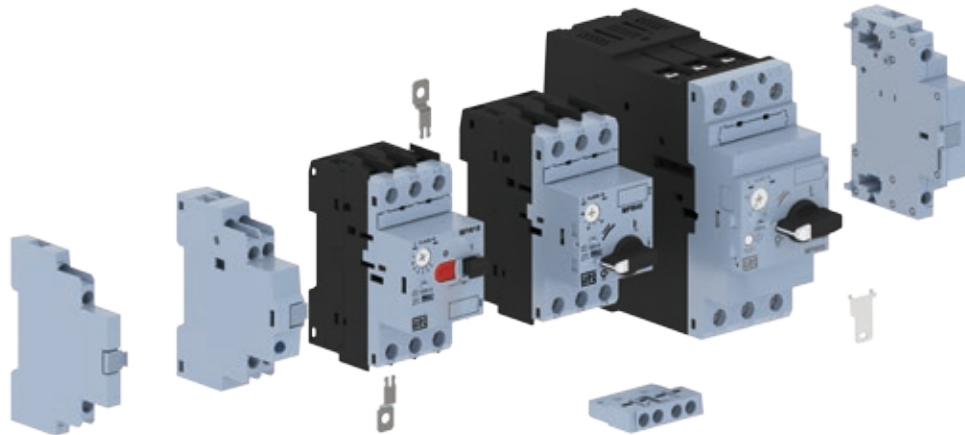

Easy Assembly

Assembly and disassembly of the side contact blocks, trip indication blocks and undervoltage coils without tools, just by means of fittings on the side of the circuit breaker.

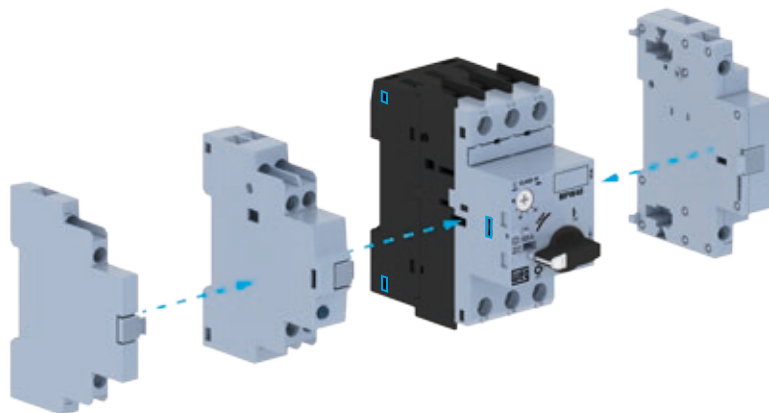

Safety in Installation

All the motor-protective circuit breakers have degree of **protection IP20** on the front to prevent inadvertent contacts with the live parts without requiring additional accessories.

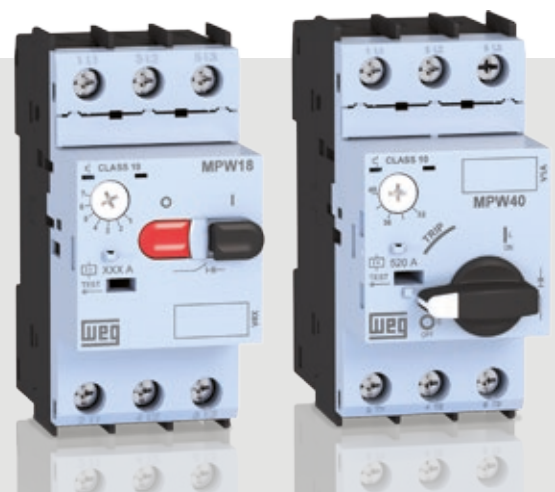



Benefits and Characteristics of Application of **Motor-Protective Circuit Breakers** on Electrical Panels



Inventory Optimization

Conventional panels that use fuses for protection against short-circuit require replacement after they trip. The spare fuses for panels with such conception require physical space in the maintenance area and inventory item control. Using the motor-protective circuit breakers, that is not necessary, because they allows reset even after a trip by short-circuit.



Shorter Downtime

Stoppages because of an overload trip may be common in some applications with this kind of characteristic in case of some anomaly. In some operations, the downtime of machines may represent huge losses and damages to industrial processes. The use of motor-protective circuit breakers provides shorter reset time of a machine/equipment, because the circuit breaker allows its reset even after a trip by short-circuit.



Design Simplification

In order to size fuses on electrical panels for motor start, it is necessary to pay attention to the time of each start: direct on-line (5s), delta-star (10s), reduced voltage (15s). Also, in the sizing of components to protect delta-star starters using fuses, we often find applications that require six fuses and thus additional wiring. Using motor-protective circuit breakers, your project is simplified down to a single component.



Cable Connection

The circuit breakers allow direct connection of cables to the circuit breaker without the need for terminals at the end of the connection cables.



Cost Reduction

The designs with motor-protective circuit breakers are smaller than those with protection by molded-case circuit breakers or fuses. They allow the assembly on DIN rail 35 mm, avoiding unnecessary expenses with fastening by screws. Over 50% of reduction of assembly space.

Conventional panels with:

Molded-case circuit breakers

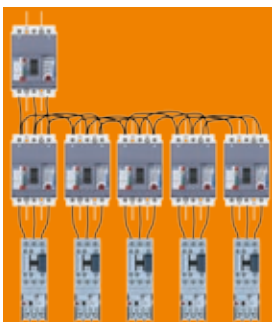

Fuses

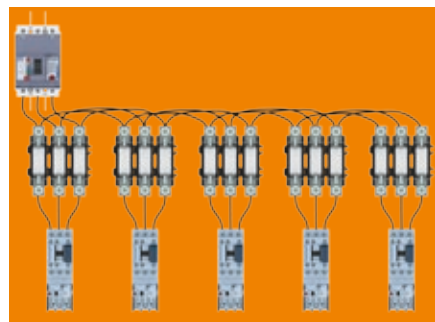

Compact panel with:

Motor-protective circuit breakers

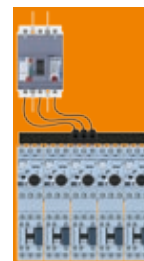

ENVIRONMENTALLY FRIENDLY

Manufactured with materials of low impact on the environment and according to the RoHS international requirements.



Issued by the Parliament and by the European Council, the **RoHS** restricts the use of hazardous substances on electronic products traded in the countries members of the EU, **prohibiting the ingress of new products on the market** in case they contain lead, cadmium, hexavalent chromium, mercury, polybrominated biphenyl (PBB) and polybrominated diphenyl ethers (PBDE). The MPW line complies with the RoHS requirements.



MPW12 Motor Protective Circuit Breaker - Overview

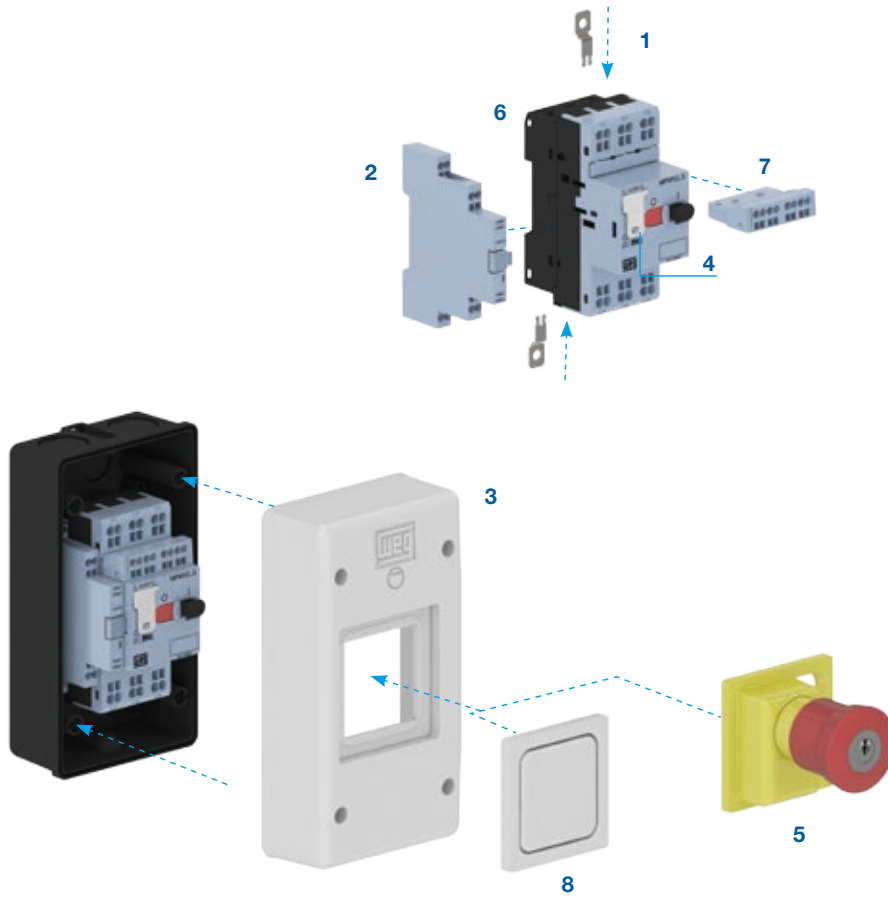

- 1 - Push-in-lugs PLMP
- 2 - Side mounted auxiliary contact block ACBS_S (spring terminal)
- 3 - Insulated enclosure
- 4 - Scale cover SCMP

- 5 - Emergency pushbutton for insulated enclosure
- 6 - MPW12 motor protective circuit breaker (spring terminal)
- 7 - Front mounted auxiliary contact block ACBF_S (spring terminal)
- 8 - MPE41 cover for IP66

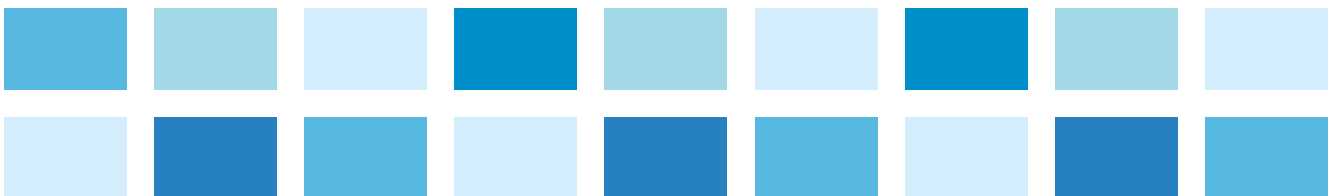



MPW12 Motor Protective Circuit Breaker - Selection Table

MPW12 Motor Protective Circuit Breaker up to 12 A - Spring Terminal

- With overload and short-circuit protection
- Fixed short-circuit release $13 \times I_n$
- With phase-failure sensitivity according to IEC 60947-4-1
- With temperature compensation
- For use as main switch (IEC 60947-2)
- Pushbutton operated



MPW12 Motor Protective Circuit Breaker - Thermomagnetic - Overload and Short-Circuit Protection

Reference values for selecting protection of three-phase electric motors ¹⁾						Rated current I_n (A)	Setting overload release  I_n (A)	Instantaneous magnetic trip $13 \times I_n$  I_m (A)	Spring terminal	Weight kg
220-240 V kW / HP	380-415 V kW / HP	440-480 V kW / HP	500 V kW / HP	550-600 V kW / HP	690 V kW / HP				Reference code	
-	-	-	-	-	-	0.16	0.1...0.16	2.08	MPW12-3-C016S	0.28
-	-	-	-	-	0.12 / 0.16	0.25	0.16...0.25	3.25	MPW12-3-C025S	
-	-	0.12 / 0.16	0.12 / 0.16	0.12 / 0.16	0.18 / 0.25	0.4	0.25...0.4	5.2	MPW12-3-D004S	
-	0.12 / 0.16	0.18 / 0.25	0.18 / 0.25	0.25 / 0.33	0.25 / 0.33	0.63	0.4...0.63	8.2	MPW12-3-C063S	
0.12 / 0.16	0.25 / 0.33	0.25 / 0.33	0.37 / 0.5	0.37 / 0.5	0.55 / 0.75	1	0.63...1	13	MPW12-3-U001S	
0.25 / 0.33	0.37 / 0.5	0.75 / 1	0.75 / 1	0.75 / 1	1.1 / 1.5	1.6	1...1.6	20.8	MPW12-3-D016S	
0.37 / 0.5	0.75 / 1	1.1 / 1.5	1.1 / 1.5	1.1 / 1.5	1.5 / 2	2.5	1.6...2.5	32.5	MPW12-3-D025S	
0.75 / 1	1.5 / 2	1.5 / 2	1.5 / 2	2.2 / 3	3 / 4	4	2.5...4	52	MPW12-3-U004S	
1.1 / 1.5	2.2 / 3	3 / 4	3 / 4	3.7 / 5	4 / 5.5	6.3	4...6.3	82	MPW12-3-D063S	
2.2 / 3	4.5 / 6	5.5 / 7.5	4 / 5.5	5.5 / 7.5	7.5 / 10	10	6.3...10	130	MPW12-3-U010S	
3 / 4	5.5 / 7.5	5.5 / 7.5	7.5 / 10	7.5 / 10	9.2 / 12.5	12	8...12	156	MPW12-3-U012S	

MPW12i Motor Protective Circuit Breaker - Magnetic - Short-Circuit Protection Only²⁾

Reference values for selecting protection of three-phase electric motors ¹⁾						Rated current I_n (A)	Instantaneous magnetic trip $13 \times I_n$  I_m (A)	Spring terminal	Weight kg
220-240 V kW / HP	380-415 V kW / HP	440-480 V kW / HP	500 V kW / HP	550-600 V kW / HP	690 V kW / HP			Reference code	
-	-	-	-	-	-	0.16	2.08	MPW12i-3-C016S	0.28
-	-	-	-	-	0.12 / 0.16	0.25	3.25	MPW12i-3-C025S	
-	-	0.12 / 0.16	0.12 / 0.16	0.12 / 0.16	0.18 / 0.25	0.4	5.2	MPW12i-3-D004S	
-	0.12 / 0.16	0.18 / 0.25	0.18 / 0.25	0.25 / 0.33	0.25 / 0.33	0.63	8.2	MPW12i-3-C063S	
0.12 / 0.16	0.25 / 0.33	0.25 / 0.25	0.37 / 0.5	0.37 / 0.5	0.55 / 0.75	1	13	MPW12i-3-U001S	
0.25 / 0.33	0.37 / 0.5	0.75 / 1	0.75 / 1	0.75 / 1	1.1 / 1.5	1.6	20.8	MPW12i-3-D016S	
0.37 / 0.5	0.75 / 1	1.1 / 1.5	1.1 / 1.5	1.1 / 1.5	1.5 / 2	2.5	32.5	MPW12i-3-D025S	
0.75 / 1	1.5 / 2	1.5 / 2	1.5 / 2	2.2 / 3	3 / 4	4	52	MPW12i-3-U004S	
1.1 / 1.5	2.2 / 3	3 / 4	3 / 4	3.7 / 5	4 / 5.5	6.3	82	MPW12i-3-D063S	
2.2 / 3	4.5 / 6	5.5 / 7.5	4 / 5.5	5.5 / 7.5	7.5 / 10	10	130	MPW12i-3-U010S	
3 / 4	5.5 / 7.5	5.5 / 7.5	7.5 / 10	7.5 / 10	9.2 / 12.5	12	156	MPW12i-3-U012S	

Notes: 1) For 50/60 Hz three-phase, 4 poles WEG W22 standard motors. These values are only for reference and may change on the number of poles and motor design;

2) For overload protection, it is suggested the use of RW27-2D thermal overload relay.

MPW18 Motor Protective Circuit Breaker - Overview

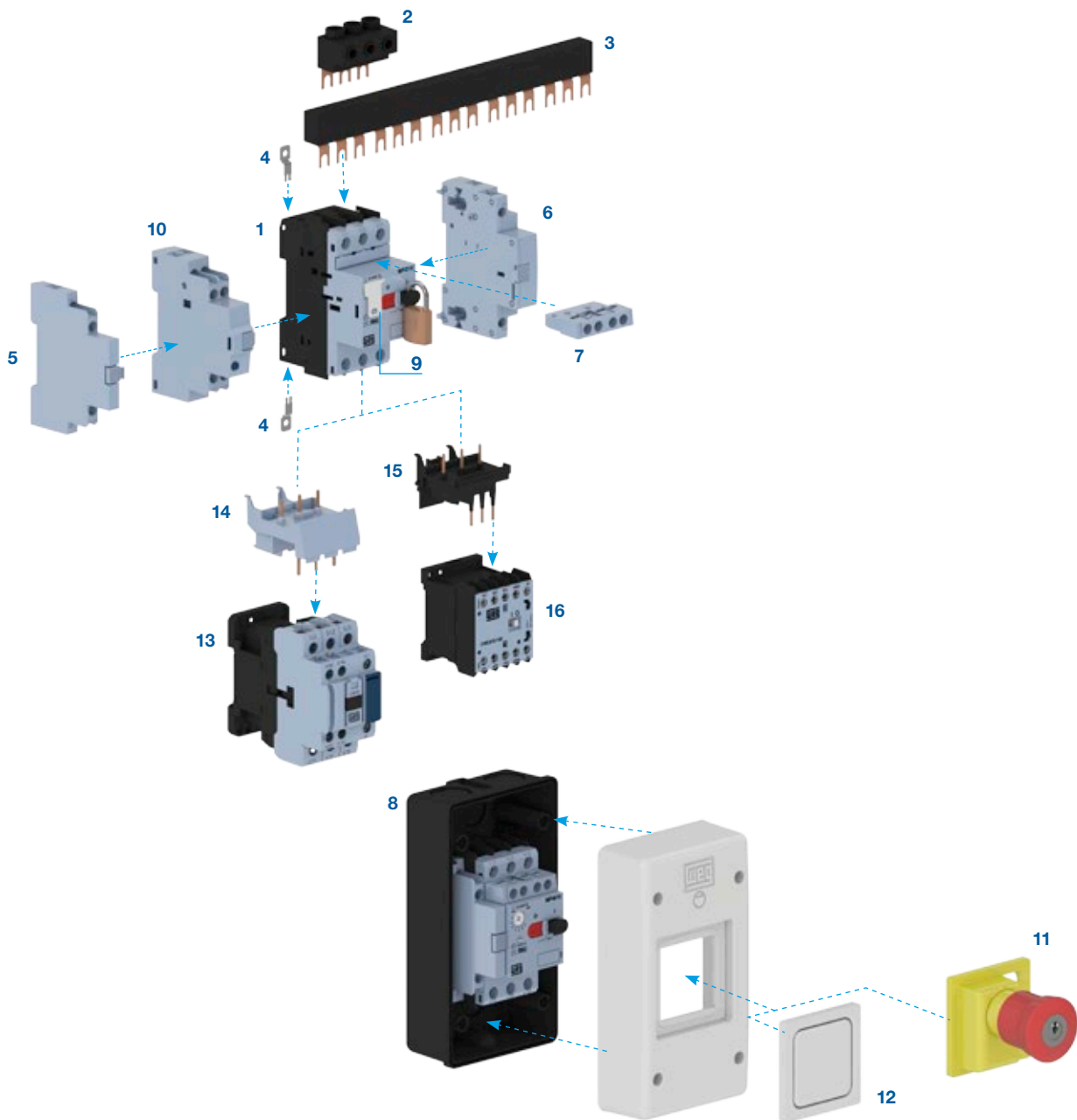

- 1 - MPW18 motor protective circuit breaker (screw terminal)
- 2 - Feeder terminal FTBBS
- 3 - Three-phase busbars BBS
- 4 - Push-in-lugs PLMP
- 5 - Side mounted auxiliary contact block ACBS (screw terminal)
- 6 - Undervoltage release URMP or shunt release SRMP (screw terminal)
- 7 - Front mounted auxiliary contact block ACBF (screw terminal)

- 8 - Insulated enclosure
- 9 - Scale cover SCMP
- 10 - Trip signaling block TSB
- 11 - Emergency pushbutton for insulated enclosure
- 12 - MPE41 cover for IP66
- 13 - CWB9...38 contactors
- 14 - Link module ECCMP-18B38 (MPW18+CWB9...38)
- 15 - Link module ECCMP-C016 (MPW18+CWC07...16)
- 16 - Compact contactors CWC07...16



MPW18 Motor Protective Circuit Breaker - Selection Table

MPW18 Motor Protective Circuit Breaker up to 18 A - Screw Terminal

- With overload and short-circuit protection
- Fixed short-circuit release $13 \times I_n$
- With phase-failure sensitivity according to IEC 60947-4-1
- With temperature compensation
- For use as main switch (IEC 60947-2)
- Pushbutton operated



MPW18 Motor Protective Circuit Breaker - Thermomagnetic - Overload and Short-Circuit Protection

Reference values for selecting protection of three-phase electric motors ¹⁾						Rated current I_n (A)	Setting overload release  I_n (A)	Instantaneous magnetic trip $13 \times I_n$  I_m (A)	Screw terminal	Weight kg
220-240 V kW / HP	380-415 V kW / HP	440-480 V kW / HP	500 V kW / HP	550-600 V kW / HP	690 V kW / HP				Reference code	
-	-	-	-	-	-	0.16	0.1...0.16	2.08	MPW18-3-C016	0.28
-	-	-	-	-	0.12 / 0.16	0.25	0.16...0.25	3.25	MPW18-3-C025	
-	-	0.12 / 0.16	0.12 / 0.16	0.12 / 0.16	0.18 / 0.25	0.4	0.25...0.4	5.2	MPW18-3-D004	
-	0.12 / 0.16	0.18 / 0.25	0.18 / 0.25	0.25 / 0.33	0.25 / 0.33	0.63	0.4...0.63	8.2	MPW18-3-C063	
0.12 / 0.16	0.25 / 0.33	0.25 / 0.33	0.37 / 0.5	0.37 / 0.5	0.55 / 0.75	1	0.63...1	13	MPW18-3-U001	
0.25 / 0.33	0.37 / 0.5	0.75 / 1	0.75 / 1	0.75 / 1	1.1 / 1.5	1.6	1...1.6	20.8	MPW18-3-D016	
0.37 / 0.5	0.75 / 1	1.1 / 1.5	1.1 / 1.5	1.1 / 1.5	1.5 / 2	2.5	1.6...2.5	32.5	MPW18-3-D025	
0.75 / 1	1.5 / 2	1.5 / 2	1.5 / 2	2.2 / 3	3 / 4	4	2.5...4	52	MPW18-3-U004	
1.1 / 1.5	2.2 / 3	3 / 4	3 / 4	3.7 / 5	4 / 5.5	6.3	4...6.3	82	MPW18-3-D063	
2.2 / 3	4.5 / 6	5.5 / 7.5	4 / 5.5	5.5 / 7.5	7.5 / 10	10	6.3...10	130	MPW18-3-U010	
3.7 / 5	7.5 / 10	9.2 / 12.5	7.5 / 10	9.2 / 12.5	9.2 / 12.5	16	10...16	208	MPW18-3-U016	
4.5 / 6	7.5 / 10	9.2 / 12.5	11 / 15	11 / 15	15 / 20	18	12...18	234	MPW18-3-U018	

MPW18i Motor Protective Circuit Breaker - Magnetic - Short-Circuit Protection²⁾

Reference values for selecting protection of three-phase electric motors ¹⁾						Rated current I_n (A)	Instantaneous magnetic trip $13 \times I_n$  I_m (A)	Screw terminal	Weight kg
220-240 V kW / HP	380-415 V kW / HP	440-480 V kW / HP	500 V kW / HP	550-600 V kW / HP	690 V kW / HP			Reference code	
-	-	-	-	-	-	0.16	2.08	MPW18i-3-C016	0.28
-	-	-	-	-	0.12 / 0.16	0.25	3.25	MPW18i-3-C025	
-	-	0.12 / 0.16	0.12 / 0.16	0.12 / 0.16	0.18 / 0.25	0.4	5.2	MPW18i-3-D004	
-	0.12 / 0.16	0.18 / 0.25	0.18 / 0.25	0.25 / 0.33	0.25 / 0.33	0.63	8.2	MPW18i-3-C063	
0.12 / 0.16	0.25 / 0.33	0.25 / 0.33	0.37 / 0.5	0.37 / 0.5	0.55 / 0.75	1	13	MPW18i-3-U001	
0.25 / 0.33	0.37 / 0.5	0.75 / 1	0.75 / 1	0.75 / 1	1.1 / 1.5	1.6	20.8	MPW18i-3-D016	
0.37 / 0.5	0.75 / 1	1.1 / 1.5	1.1 / 1.5	1.1 / 1.5	1.5 / 2	2.5	32.5	MPW18i-3-D025	
0.75 / 1	1.5 / 2	1.5 / 2	1.5 / 2	2.2 / 3	3 / 4	4	52	MPW18i-3-U004	
1.1 / 1.5	2.2 / 3	3 / 4	3 / 4	3.7 / 5	4 / 5.5	6.3	82	MPW18i-3-D063	
2.2 / 3	4.5 / 6	5.5 / 7.5	4 / 5.5	5.5 / 7.5	7.5 / 10	10	130	MPW18i-3-U010	
3.7 / 5	7.5 / 10	9.2 / 12.5	7.5 / 10	9.2 / 12.5	9.2 / 12.5	16	208	MPW18i-3-U016	
4.5 / 6	7.5 / 10	9.2 / 12.5	11 / 15	11 / 15	15 / 20	18	234	MPW18i-3-U018	

Notes: 1) For 50/60 Hz three-phase, 4 poles WEG W22 standard motors. These values are only for reference and may change on the number of poles and motor design.

2) For overload protection, it is suggested the use of RW27-2D thermal overload relay.

MPW40 Motor Protective Circuit Breaker - Overview

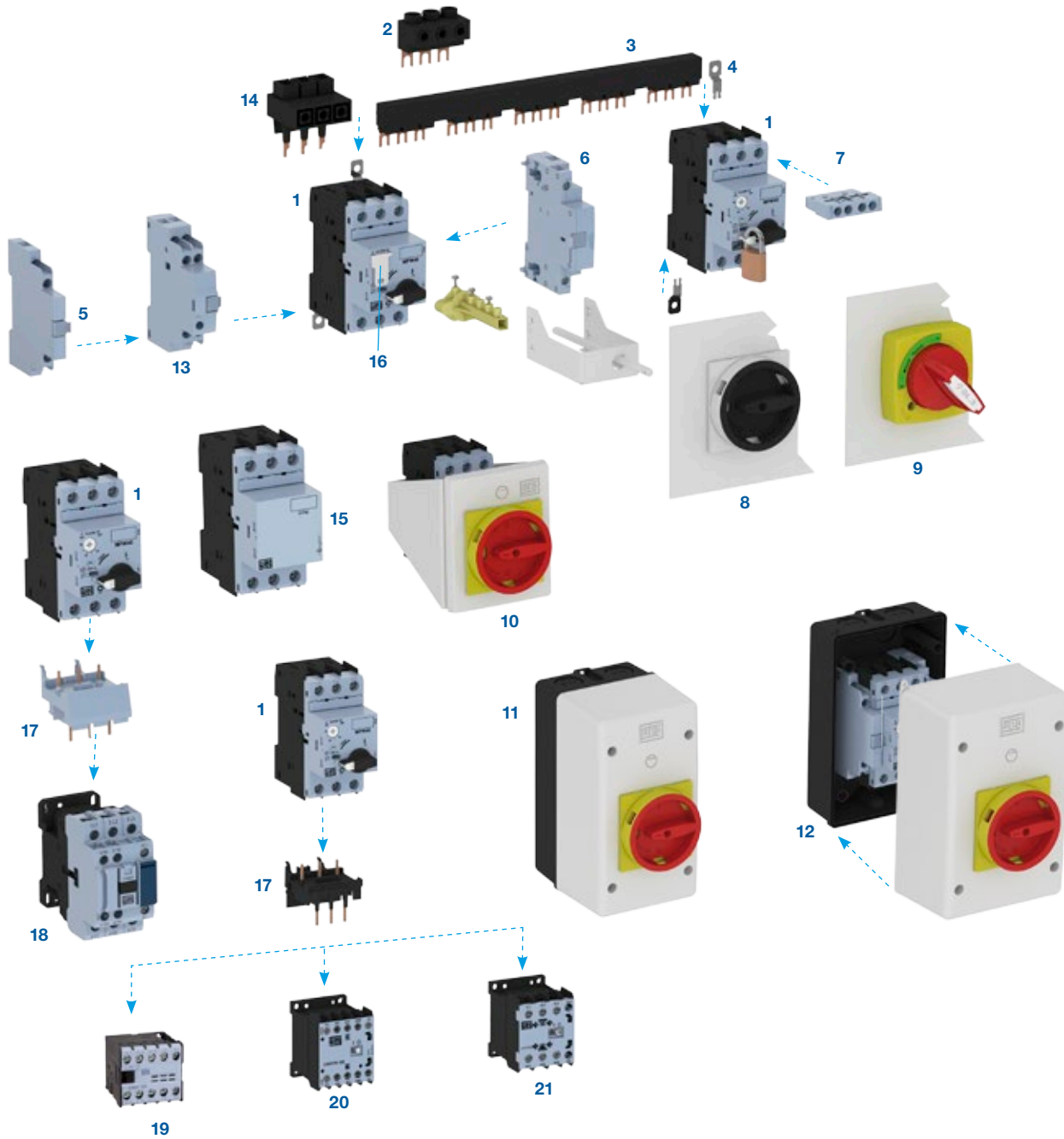

- | | |
|---|---|
| <ul style="list-style-type: none"> 1 - MPW40 motor protective circuit breaker (screw terminal) 2 - Feeder terminal FTBBS 3 - Three-phase busbars BBS 4 - Push-in-lugs PLMP 5 - Side mounted auxiliary contact block ACBS (screw terminal) 6 - Undervoltage release URMP or shunt release SRMP (screw terminal) 7 - Front mounted auxiliary contact block ACBF (screw terminal) 8 - Door coupling rotary handle RMMP 9 - Door coupling rotary handle MRX 10 - Front plate FME55 11 - Standard insulated enclosure MPE55 | <ul style="list-style-type: none"> 12 - Large insulated enclosure MLPE55 13 - Trip signaling block TSB 14 - LST25 - Feeder terminal for "Type E" motor starter according to UL 15 - Current limiter CLT32 16 - Scale cover SCMP 17 - Link modules ECCMP 18 - CWB9...38 contactors 19 - CW07 miniature contactor 20 - CWC07...16 compact contactor 21 - CWC025 compact contactor |
|---|---|

MPW40 Motor Protective Circuit Breaker - Selection Table

MPW40 Motor Protective Circuit Breaker up to 40 A - Screw Terminal

- With overload and short-circuit protection
- Fixed short-circuit release $13 \times I_n$
- With phase-failure sensitivity according to IEC 60947-4-1
- With temperature compensation
- For use as main switch (IEC 60947-2)
- Rotary handle operated



MPW40 Motor Protective Circuit Breaker - Thermomagnetic - Overload and Short-Circuit Protection

Reference values for selecting protection of three-phase electric motors ¹⁾						Rated current I_n (A)	Setting overload release I_n (A)	Instantaneous magnetic trip $13 \times I_n$ I_m (A)	Screw terminal	Weight kg
220-240 V kW / HP	380-415 V kW / HP	440-480 V kW / HP	500 V kW / HP	550-600 V kW / HP	690 V kW / HP				Reference code	
-	-	-	-	-	-	0.16	0.1...0.16	2.08	MPW40-3-C016	0.36
-	-	-	-	-	0.12 / 0.16	0.25	0.16...0.25	3.25	MPW40-3-C025	
-	-	0.12 / 0.16	0.12 / 0.16	0.12 / 0.16	0.18 / 0.25	0.4	0.25...0.4	5.2	MPW40-3-D004	
-	0.12 / 0.16	0.18 / 0.25	0.18 / 0.25	0.25 / 0.33	0.25 / 0.33	0.63	0.4...0.63	8.2	MPW40-3-C063	
0.12 / 0.16	0.25 / 0.33	0.25 / 0.33	0.37 / 0.5	0.37 / 0.5	0.55 / 0.75	1	0.63...1	13	MPW40-3-U001	
0.25 / 0.33	0.37 / 0.5	0.75 / 1	0.75 / 1	0.75 / 1	1.1 / 1.5	1.6	1...1.6	20.8	MPW40-3-D016	
0.37 / 0.5	0.75 / 1	1.1 / 1.5	1.1 / 1.5	1.1 / 1.5	1.5 / 2	2.5	1.6...2.5	32.5	MPW40-3-D025	
0.75 / 1	1.5 / 2	1.5 / 2	1.5 / 2	2.2 / 3	3 / 4	4	2.5...4	52	MPW40-3-U004	
1.1 / 1.5	2.2 / 3	3 / 4	3 / 4	3.7 / 5	4 / 5.5	6.3	4...6.3	82	MPW40-3-D063	
2.2 / 3	4.5 / 6	5.5 / 7.5	4 / 5.5	5.5 / 7.5	7.5 / 10	10	6.3...10	130	MPW40-3-U010	
3.7 / 5	7.5 / 10	9.2 / 12.5	9.2 / 12.5	11 / 15	11 / 15	16	10...16	208	MPW40-3-U016	
5.5 / 7.5	9.2 / 12.5	11 / 15	11 / 15	-	15 / 20	20	16...20	260	MPW40-3-U020	
-	11 / 15	-	15 / 20	15 / 20	18.5 / 25	25	20...25	325	MPW40-3-U025	
9.2 / 12.5	15 / 20	15 / 20	18.5 / 25	22 / 30	22 / 30	32	25...32	416	MPW40-3-U032	
11 / 15	18.5 / 25	18.5 / 25	22 / 30	-	37 / 50	40	32...40	520	MPW40-3-U040	

MPW40i Motor Protective Circuit Breaker - Magnetic - Short-Circuit Protection²⁾

Reference values for selecting protection of three-phase electric motors ¹⁾						Rated current I_n (A)	Instantaneous magnetic trip $13 \times I_n$ I_m (A)	Screw terminal	Weight kg
220-240 V kW / HP	380-415 V kW / HP	440-480 V kW / HP	500 V kW / HP	550-600 V kW / HP	690 V kW / HP			Reference code	
-	-	-	-	-	-	0.16	2.08	MPW40i-3-C016	0.36
-	-	-	-	-	0.12 / 0.16	0.25	3.25	MPW40i-3-C025	
-	-	0.12 / 0.16	0.12 / 0.16	0.12 / 0.16	0.18 / 0.25	0.4	5.2	MPW40i-3-D004	
-	0.12 / 0.16	0.18 / 0.25	0.18 / 0.25	0.25 / 0.33	0.25 / 0.33	0.63	8.2	MPW40i-3-C063	
0.12 / 0.16	0.25 / 0.33	0.25 / 0.33	0.37 / 0.5	0.37 / 0.5	0.55 / 0.75	1	13	MPW40i-3-U001	
0.25 / 0.33	0.37 / 0.5	0.75 / 1	0.75 / 1	0.75 / 1	1.1 / 1.5	1.6	20.8	MPW40i-3-D016	
0.37 / 0.5	0.75 / 1	1.1 / 1.5	1.1 / 1.5	1.1 / 1.5	1.5 / 2	2.5	32.5	MPW40i-3-D025	
0.75 / 1	1.5 / 2	1.5 / 2	1.5 / 2	2.2 / 3	3 / 4	4	52	MPW40i-3-U004	
1.1 / 1.5	2.2 / 3	3 / 4	3 / 4	3.7 / 5	4 / 5.5	6.3	82	MPW40i-3-D063	
2.2 / 3	4.5 / 6	5.5 / 7.5	4 / 5.5	5.5 / 7.5	7.5 / 10	10	130	MPW40i-3-U010	
3.7 / 5	7.5 / 10	9.2 / 12.5	9.2 / 12.5	11 / 15	11 / 15	16	208	MPW40i-3-U016	
5.5 / 7.5	9.2 / 12.5	11 / 15	11 / 15	-	15 / 20	20	260	MPW40i-3-U020	
-	11 / 15	-	15 / 20	15 / 20	18.5 / 25	25	325	MPW40i-3-U025	
9.2 / 12.5	15 / 20	15 / 20	18.5 / 25	22 / 30	22 / 30	32	416	MPW40i-3-U032	
11 / 15	18.5 / 25	18.5 / 25	22 / 30	-	37 / 50	40	520	MPW40i-3-U040	

Notes: 1) For 50/60 Hz three-phase, 4 poles WEG W22 standard motors. These values are only for reference and may change on the number of poles and motor design.

2) For overload protection, it is suggested the use of RW27-2D thermal overload relay.

MPW80 Motor Protective Circuit Breaker - Overview

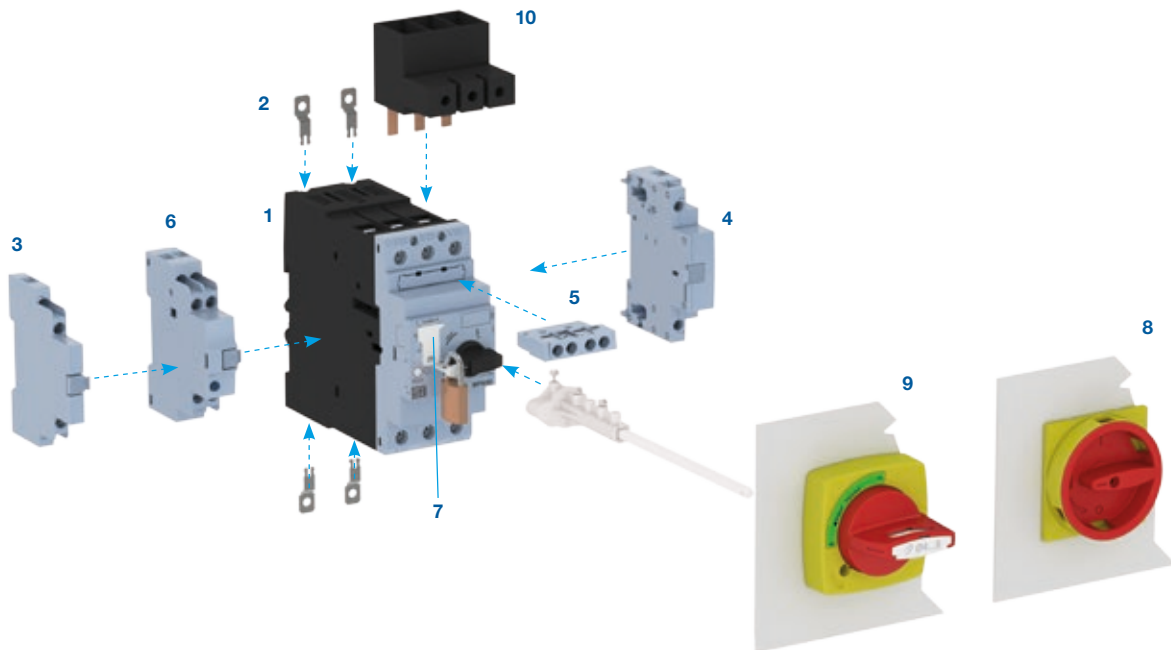

- 1 - Motor protective circuit breaker MPW80
- 2 - Push-in-lugs PLMP
- 3 - Side auxiliary contact block ACBS
- 4 - Undervoltage release URMP or shunt release SRMP
- 5 - Frontal auxiliary contact block ACBF
- 6 - Trip signalling block TSB
- 7 - Scale cover SCMP
- 8 - Door coupling rotary handle RMMP65
- 9 - Door coupling rotary handle MRX65
- 10 - Feeder terminal for "Type E" motor starter according to UL LST65

MPW80 Motor Protective Circuit Breaker - Selection Table

MPW80 Motor Protective Circuit Breaker up to 80 A - Screw Terminal

- With overload and short-circuit protection
- Fixed short-circuit release $13 \times I_u$
- With phase-failure sensitivity according to IEC 60947-4-1
- With temperature compensation
- For use as main switch (IEC 60947-2)
- Rotary handle operated



MPW80 Motor Protective Circuit Breaker - Thermomagnetic - Overload and Short-Circuit Protection

Reference values for selecting protection of three-phase electric motors ¹⁾						Rated current I_r (A)	Setting overload release I_r (A)	Instantaneous magnetic trip $13 \times I_r$ I_m (A)	"Box" terminal	Weight kg
220-240 V	380-415 V	440-480 V	500 V	550-600 V	690 V				Reference code	
kW / HP	kW / HP	kW / HP	kW / HP	kW / HP	kW / HP					
11 / 15	18.5 / 25	22 / 30	22 / 30	30 / 40	37 / 50	40	32...40	520	MPW80-3-U040	1.07
-	22 / 30	30 / 40	30 / 40	37 / 50	45 / 60	50	40...50	650	MPW80-3-U050	
18.5 / 25	30 / 40	37 / 50	45 / 60	45 / 60	55 / 75	65	50...65	845	MPW80-3-U065	
22 / 30	37 / 50	45 / 60	55 / 75	55 / 75	75 / 100	80	65...80	1,040	MPW80-3-U080	

MPW80i Motor Protective Circuit Breaker - Magnetic - Short-Circuit Protection²⁾

Reference values for selecting protection of three-phase electric motors ¹⁾						Rated current I_r (A)	Instantaneous magnetic trip $13 \times I_r$ I_m (A)	"Box" terminal	Weight kg
220-240 V	380-415 V	440-480 V	500 V	550-600 V	690 V			Reference code	
kW / HP	kW / HP	kW / HP	kW / HP	kW / HP	kW / HP				
11 / 15	18.5 / 25	22 / 30	22 / 30	30 / 40	37 / 50	40	520	MPW80i-3-U040	1.07
-	22 / 30	30 / 40	30 / 40	37 / 50	45 / 60	50	650	MPW80i-3-U050	
18.5 / 25	30 / 40	37 / 50	45 / 60	45 / 60	55 / 75	65	845	MPW80i-3-U065	
22 / 30	37 / 50	45 / 60	55 / 75	55 / 75	75 / 100	80	1,040	MPW80i-3-U080	

Notes: 1) For 50/60 Hz three-phase, 4 poles WEG W22 standard motors. These values are only for reference and may change on the number of poles and motor design.

2) For overload protection, it is suggested the use thermal overload relay.

3) In progress.

MPW100 Motor Protective Circuit Breaker - Overview

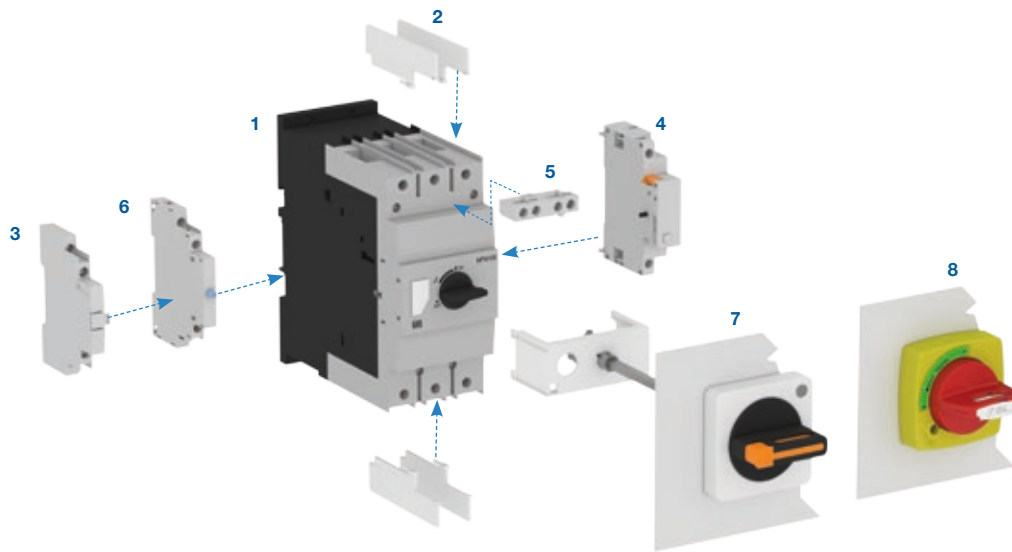

- 1 - Frontal auxiliary contact block ACBF
- 2 - IB insulators
- 3 - Side auxiliary contact block ACBS_ MPW100
- 4 - Undervoltage release URMP_ MPW100 or shunt release SRMP_ MPW100
- 5 - Frontal auxiliary contact block ACBF_ MPW100
- 6 - Trip signalling block TSB_ MPW100
- 7 - Door coupling rotary handle MR MPW100
- 8 - Door coupling rotary handle MRX100

MPW100 Motor Protective Circuit Breaker - Selection Table

Motor Protective Circuit Breaker MPW100 - Screw Terminal

- With overload and short-circuit protection
- Fixed short-circuit release $13 \times I_n$
- With phase-failure sensitivity according to IEC 60947-4-1
- With temperature compensation
- For use as main switch
- Supplied with current scale cover protection



MPW100 Motor Protective Circuit Breaker - Thermomagnetic - Overload and Short-Circuit Protection

Reference values for selecting protection of three-phase electric motors ¹⁾						Rated current I_r (A)	Setting overload release I_r (A)	Instantaneous magnetic trip $13 \times I_r$ I_m (A)	"Box" terminal	Weight kg
220-240 V	380-415 V	440-480 V	500 V	550-600 V	690 V				Reference code	
kW / HP	kW / HP	kW / HP	kW / HP	kW / HP	kW / HP					
18.5 / 25	37 / 50	45 / 60	45 / 60	55 / 75	55 / 75	75	55...75	975	MPW100-3-U075	2.2
22 / 30	45 / 60	55 / 75	55 / 75	55 / 75	75 / 100	90	70...90	1,170	MPW100-3-U090	
30 / 40	45 / 60	55 / 75	55 / 75	55 / 75	90 / 125	100	80...100	1,300	MPW100-3-U100	

Notes: 1) For 50/60 Hz three-phase, 4 poles WEG W22 standard motors. These values are only for reference and may change on the number of poles and motor design.
 2) For overload protection, it is suggested the use thermal overload relay.
 3) In progress.

MPW40t Motor Protective Circuit Breaker - Selection Table

MPW40t Motor Protective Circuit Breaker up to 20 A - Screw Terminal

- Motor protective circuit breaker for protection of transformers or motors with high starting current
- Allows switching and protection against overload and short-circuit of inductive loads
- Fixed short-circuit release $19 \times I_u$
- Breaking capacity 100 kA at 380-415 V ac up to 10 A
- With phase-failure sensitivity according to IEC 60947-4-1
- With temperature compensation
- Rotary handle operated
- For use as main switch



MPW40t Motor Protective Circuit Breaker - Thermomagnetic - Overload and Short-Circuit Protection



Reference values for selecting protection of three-phase electric motors ¹⁾						Rated current In (A)	Setting overload release In (A)	Instantaneous magnetic trip 13 x In Im (A)	Screw terminal	Weight kg
220-240 V kW / HP	380-415 V kW / HP	440-480 V kW / HP	500 V kW / HP	550-600 V kW / HP	690 V kW / HP				Reference code	
-	-	-	-	-	-	0.16	0.1...0.16	3.0	MPW40t-3-C016	0.36
-	-	-	-	-	0.12 / 0.16	0.25	0.16...0.25	4.8	MPW40t-3-C025	
-	-	0.12 / 0.16	0.12 / 0.16	0.12 / 0.16	0.18 / 0.25	0.4	0.25...0.4	7.6	MPW40t-3-D004	
-	0.12 / 0.16	0.18 / 0.25	0.18 / 0.25	0.25 / 0.33	0.25 / 0.33	0.63	0.4...0.63	12.0	MPW40t-3-C063	
0.12 / 0.16	0.25 / 0.33	0.25 / 0.33	0.37 / 0.5	0.37 / 0.5	0.55 / 0.75	1	0.63...1	19.0	MPW40t-3-U001	
0.25 / 0.33	0.37 / 0.5	0.75 / 1	0.75 / 1	0.75 / 1	1.1 / 1.5	1.6	1...1.6	30.4	MPW40t-3-D016	
0.37 / 0.5	0.75 / 1	1.1 / 1.5	1.1 / 1.5	1.1 / 1.5	1.5 / 2	2.5	1.6...2.5	47.5	MPW40t-3-D025	
0.75 / 1	1.5 / 2	1.5 / 2	1.5 / 2	2.2 / 3	3 / 4	4	2.5...4	76.0	MPW40t-3-U004	
1.1 / 1.5	2.2 / 3	3 / 4	3 / 4	3.7 / 5	4 / 5.5	6.3	4...6.3	119.7	MPW40t-3-D063	
2.2 / 3	4.5 / 6	5.5 / 7.5	4 / 5.5	5.5 / 7.5	7.5 / 10	10	6.3...10	190.0	MPW40t-3-U010	
3.7 / 5	7.5 / 10	9.2 / 12.5	9.2 / 12.5	11 / 15	11 / 15	16	10...16	304.0	MPW40t-3-U016	
5.5 / 7.5	9.2 / 12.5	11 / 15	11 / 15	-	15 / 20	20	16...20	380.0	MPW40t-3-U020	





Note: 1) For 50/60 Hz three-phase, 4 poles WEG W22 standard motors. These values are only for reference and may change on the number of poles and motor design.

Accessories

Front Auxiliary Contact Block - ACBF³⁾

For use with	Illustrative picture	Auxiliary contacts		Reference code	Weight kg
		NO	NC		
MPW12		1	1	ACBF-11S	0.024
MPW18 MPW40 MPW80				ACBF-11	
MPW100				ACBF-11 MPW100	0.018



Left Side Auxiliary Contact Block - ACBS³⁾

For use with	Illustrative picture	Auxiliary contacts		Reference code	Weight kg
		NO	NC		
MPW12 ¹⁾		1	1	ACBS-11S	0.045
		2	-	ACBS-20S	
		-	2	ACBS-02S	
MPW18 MPW40 MPW80		1	1	ACBS-11	0.030
		2	-	ACBS-20	
		-	2	ACBS-02	
MPW100		1	1	ACBS-11 MPW100	0.030
		2	-	ACBS-20 MPW100	
		-	2	ACBS-02 MPW100	

Trip Signalling Block - TSB¹⁾³⁾

For use with	Illustrative picture	Description	Reference code	Weight kg
MPW18 MPW40 MPW80		- Equipped with 2 auxiliary contacts (1NO + 1NC) for overload trip signalling and 2 other auxiliary contacts (1NO + 1NC) for short-circuit trip signalling - To reset the circuit breaker after a short-circuit, the flag must be manually reset after the cause of the failure has been solved - Lateral auxiliary contacts can be assembled together with the trip signalling block - Left side assembly only	TSB	0.130
MPW100		- Equipped with 2 auxiliary contacts (1NO + 1NC) for overload and short-circuit trip signalling - Left side assembly only	TSB AT11 MPW100	0.060
		- Equipped with 2 auxiliary contacts (1NO + 1NC) for short-circuit trip signalling - Left side assembly only	TSB SC-11 MPW100	

Undervoltage Release - URMP²⁾³⁾

For use with	Illustrative picture	Description	Voltage and frequency ²⁾	Reference code	Weight kg
MPW18 MPW40 MPW80		- Operating voltage: >0.85...1.1 x U ₀ - Non operating voltage <0.35...0.7 x U ₀ - Right side assembly only	220 V 50/60 Hz	URMP D23	0.130
			24 V 50/60 Hz	URMP D02	
			110 V 50 Hz / 120 V 60 Hz	URMP V18	
			110-115 V 50 Hz / 127 V 60 Hz	URMP V19	
			180 V 50 Hz / 208 V 60 Hz	URMP V23	
			190 V 50 Hz / 220 V 60 Hz	URMP V26	
			208 V 50 Hz / 240 V 60 Hz	URMP V30	
			220 V 50 Hz / 255 V 60 Hz	URMP V32	
			230-240 V 50 Hz / 277 V 60 Hz	URMP V37	
			325 V 50 Hz / 380 V 60 Hz	URMP V41	
MPW100		- Operating voltage > 0.85 x U ₀ - Non operating voltage 0.35...0.7 x U ₀ - Right side assembly only	110 V 50 Hz / 120 V 60 Hz	URMP V18 MPW100	0.018
			220-230 V 50 Hz / 240-260 V 60 Hz	URMP V33 MPW100	
			380-400 V 50 Hz / 440-460 V 60 Hz	URMP V43 MPW100	
			200 V 50 Hz / 200-220 V 60 Hz	URMP VD1 MPW100	

Notes: 1) The accessories Trip Signalling Block TSB, Undervoltage Release URMP and Shunt Release SRMP are also suitable for use with MPW12 even though they are not available in spring terminal version.

2) Other voltages available upon request.

3) Maximum configuration of the following accessories can be assembled at the same time:

- ACBF + TSB + URMP or SRMP;
- ACBS + TSB + URMP or SRMP;
- ACBF + ACBS + URMP or SRMP.

Accessories

Shunt Release - SRMP¹⁾²⁾

For use with	Illustrative picture	Description	Voltage and frequency ²⁾	Reference code	Weight kg
MPW18 MPW40 ¹⁾ MPW80		- Operating voltage: $0.7...1.1 \times U_e$ - Right side assembly only	20-24 V 50/60 Hz	SRMP D51	0.130
			40-48 V 50/60 Hz	SRMP D54	
			100-127 V 50/60 Hz	SRMP D59	
			200-240 V 50/60 Hz	SRMP D65	
			365-440 V 50/60 Hz	SRMP D69	
MPW100		- Operating voltage $> 0.7 \times U_e$ - Right side assembly only	110 V 50 Hz / 120 V 60 Hz	SRMP V18 MPW100	0.040
			220-230 V 50 Hz / 240-260 V 60 Hz	SRMP V33 MPW100	
			380-400 V 50 Hz / 440-460 V 60 Hz	SRMP V43 MPW100	
			200 V 50 Hz / 200-230 V 60 Hz	SRMP V01 MPW100	

Insulators for UL - IB

For use with	Illustrative picture	Description	Reference code	Weight kg
MPW100		Insulators for increasing creepage distance and clearances according to UL requirements. Package with 4 pieces	IB MPW100	0.010

Block Modules for Motor Protective Circuit Breaker Assembly + Contactors - ECCMP

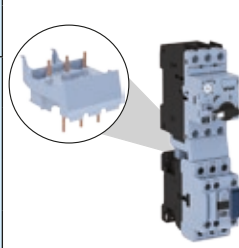
For use with	Illustrative picture	Description	Contactors	Reference code	Weight kg
MPW18		For direct connection (electrical and mechanical) of motor circuit breakers to contactors	CWC07...16 (AC or DC coil)	ECCMP-C016	0.025
			CWB9...38 (AC coil)	ECCMP-18B38	
			CW07 (AC coil)	ECCMP-07	
MPW40			CWC07...16 (AC or DC coil)	ECCMP-C0	
			CWC025 (AC coil)	ECCMP-C025	
			CWM9...25 (AC coil)	ECCMP-25	
			CWM32/40 (AC coil)	ECCMP-32	
			CWB9...38 (AC coil)	ECCMP-40B38	
			CWB9...38 (DC coil)	ECCMP-40B38DC	





Notes: 1) The accessories Trip Signalling Block TSB, Undervoltage Release URMP and Shunt Release SRMP are also suitable for use with MPW12 even though they are not available in spring terminal version.

2) Maximum configuration of the following accessories can be assembled at the same time:

- ACBF + TSB + URMP or SRMP;
- ACBS + TSB + URMP or SRMP;
- ACBF + ACBS + URMP or SRMP.

Accessories

Door Coupling Rotary Handle - RMMP and MRX

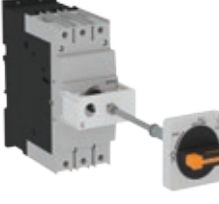
For use with	Illustrative picture	Description	Handle color	Reference code	Weight kg	
MPW40		<ul style="list-style-type: none"> - Degree of protection IP55 - Shows circuit breaker position "I"(ON) or "O"(OFF) - Panel door can only be opened in OFF position - Adjustable shaft length. There are 2 standard shaft sizes: 130-155 mm (Model 130) and 330-355 mm (Model 330). To assembled the handle on the circuit breaker the shaft must have a length of at least 80 mm - Up to 3 padlocks can be used in the OFF position. This blocks circuit breaker operation and opens panel door - Handle can be mounted on panels with a thickness of 1 to 5 mm - Handle can be assembled even with circuit breaker turned in 90° position 	Black	RMMP-130	0.140	
				RMMP-330	0.175	
			Red and Yellow	RMMP-130E	0.140	
				RMMP-330E	0.175	
MPW80				Black	RMMP65-130	0.139
					RMMP65-330	0.175
				Red and Yellow	RMMP65-130E	0.139
					RMMP65-330E	0.175
MPW40		<ul style="list-style-type: none"> - Panel door can be opened in ON position (thermometry) - Degree of protection: MRX = IP65/Nema 4X - Shows circuit breaker position "I"(ON) or "O"(OFF) - Adjustable shaft length. There are 2 standard shaft sizes: 130-155 mm (Model 130) and 330-355 mm (Model 330). To assemble the handle ON the circuit breaker the shaft must have a length of at least 80 mm - Up to 3 padlocks can be used in the OFF position. This blocks circuit breaker operation and opens panel door - Handle can be mounted on panels with a thickness of 1 to 5 mm 		Black	MRX-130	0.185
					MRX-330	0.220
				Red and Yellow	MRX-130E	0.185
					MRX-330E	0.220
MPW80				Black	MRX65-130	0.250
					MRX65-330	0.280
				Red and Yellow	MRX65-130E	0.250
					MRX65-330E	0.280
MPW100		<ul style="list-style-type: none"> - Degree of protection: IP65 - Shows circuit breaker position "I"(ON) or "O"(OFF) - Adjustable shaft length. There are 2 standard shaft sizes: 220-282 mm (Model 115) and 220-482 mm (Model 315) - Up to 3 padlocks can be used in the OFF position. This blocks circuit breaker operation and opens panel door 		Black	MRX100-130	0.151
				Red and Yellow	MRX100-130E	0.151
				Gray	MR MPW100-115	0.170
					MR MPW100-315	0.200

Accessories

Insulated Enclosures for MPW12 and MPW18 - PE41 / PE66 / MPE41 / MPE66

For use with	Illustrative picture	Description	Terminals	Protection degree	Knock-out versions		Weight kg
					Metric	PG	
MPW12 MPW18		<ul style="list-style-type: none"> - Empty plastic enclosure - Degree of protection: IP41 or IP66 - Allows installing: MPW + ACBF11/PL lamps + ACBS - Color: cover (grey RAL 7035) and base (black RAL 7021) - Two M20 metric cable entry, back - Two cable entry knockouts, top and bottom (M25 for metric version and PG16 for PG version) 	-	IP41	MPE41	PE41	0.41
			Ground	IP41	MPE41G	PE41G	0.41
			Ground and neutral	IP41	MPE41GN	PE41GN	0.41
	-		IP66	MPE66	PE66	0.41	
	Ground		IP66	MPE66G	PE66G	0.41	
	Ground and neutral		IP66	MPE66GN	PE66GN	0.41	

Accessories for Standard Insulated Enclosures PE41 / PE66 / MPE41 / MPE66

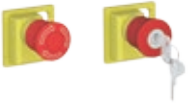
For use with	Illustrative picture	Description	Reference	Weight kg
PE41 MPE41		Enable to increase degree of protection from PE41 or MPE41 (IP41) to IP66	KIT66PE	0.016
PE41 MPE41 PE66 MPE66		Emergency stop button: twist to release	FESTPE	0.060
		Emergency stop button: push to release	FESPPE	0.060
		Emergency stop button: key to release	FESYPE	0.125

Standard Size Insulated Enclosures for MPW40 - MPE55 / PE55

For use with	Illustrative picture	Description	Terminals	Handle color	Knock-out versions		Weight kg
					Metric	PG	
MPW40		<ul style="list-style-type: none"> - Empty plastic enclosure; - Degree of protection: IP55; - Allows installing: MPW + ACBF11/PL lamps + ACBS; - Rotary handle on the cover connected on MPW's handle; - Handle can be locked with up to 3 padlocks in "OFF" position; - Color: cover (grey RAL 7035) and base (black RAL 7021). - Two M20 metric cable entry, back; - Two cable entry knockouts, top and bottom (M25 for metric version and PG16 for PG version) 	-	Black	MPE55	PE55	0.44
			-	Red	MPE55E	PE55E	0.44
			Ground	Black	MPE55G	PE55G	0.54
				Red	MPE55G-E	PE55G-E	0.54
			Ground and neutral	Black	MPE55GN	PE55GN	0.45
				Red	MPE55GN-E	PE55GN-E	0.45

Large Size Insulated Enclosures for MPW40 - LMPE55 / LPE55

For use with	Illustrative picture	Description	Terminals	Handle color	Knock-out versions		Weight kg
					Metric	PG	
MPW40		<ul style="list-style-type: none"> - Empty plastic enclosure; - Degree of protection: IP55; - Allows installing: MPW + ACBF11/PL lamps + ACBS + URMP/ SRMP; - Rotary handle on the cover connected on MPW's handle; - Handle can be locked with up to 3 padlocks in "OFF" position; - Color: cover (grey RAL 7035) and base (black RAL 7021). - Two M20 metric cable entry, back; - Two cable entry knockouts, top and bottom (M25 for metric version and PG16 for PG version) 	-	Black	LMPE55	LPE55	0.44
			-	Red	LMPE55E	LPE55E	0.44
			Ground	Black	LMPE55G	LPE55G	0.54
				Red	LMPE55G-E	LPE55G-E	0.54
			Ground and neutral	Black	LMPE55GN	LPE55GN	0.45
				Red	LMPE55GN-E	LPE55GN-E	0.45

Front Plate - FME55



For use with	Illustrative picture	Description	Handle color	Reference	Weight kg
MPW40		<ul style="list-style-type: none"> - For motor protective circuit breaker assembly in panel door or side; - Mounted on panels with a thickness of 1 to 5 mm; - Frontal protection degree IP55; - Allows installing: MPW + ACBF11/PL lamps + ACBS/ TSB + URMP/ SRMP; - Rotary handle on the cover connected on MPW's handle; - Handle can be locked with up to 3 padlocks in "OFF" position; - Color: cover (grey RAL 7035). 	Black	FME55	0.41
			Red	FME55E	0.41

Accessories

Pilot Light - PL

For use with	Illustrative picture	Lamp color	Voltage and frequency	Reference	Weight kg
All models		Red	24 V dc / 50/60 Hz	PL24 E26	0.005
			110...130 V 50/60 Hz	PL130 D61	
			210...230 V 50/60 Hz	PL230 D78	
			400...560 V 50/60 Hz	PL560 D79	
		Green	24 V dc / 50/60 Hz	PL24G E26	
			110...130 V 50/60 Hz	PL130G D61	
			210...230 V 50/60 Hz	PL230G D78	
			400...560 V 50/60 Hz	PL560G D79	
		White	24 V dc / 50/60 Hz	PL24W E26	
			110...130 V 50/60 Hz	PL130W D61	
			210...230 V 50/60 Hz	PL230W D78	
			400...560 V 50/60 Hz	PL560W D79	

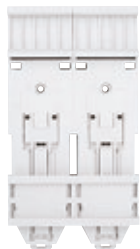

Motor Protective Circuit Breaker Mounting Adapter + Contactor - MA

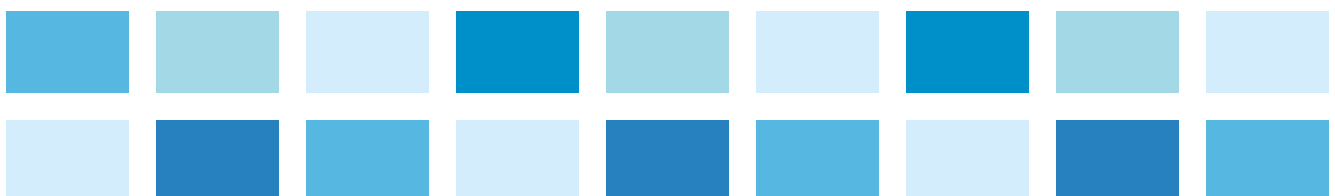
For use with	Illustrative picture	Description	Contactors	Reference	Weight kg
MPW12 MPW18 MPW40		<ul style="list-style-type: none"> - Used for direct on line starters; - Adapter fixed by screws or DIN rail 35 mm; - 45 mm width; - Motor protective circuit breaker + contactors: connection by cables; - Engineering plastic material. 	CWC07...25 CWM9...25 CWB9...38	MA45DOL	0.025
MPW12 MPW18 MPW40		<ul style="list-style-type: none"> - Used for reversing starters; - Adapter fixed by screws or DIN rail 35 mm; - 90 mm width; - Motor protective circuit breaker + contactors: connection by cables; - Engineering plastic material. 	2 x CWC07...25 2 x CWM9...25 2 x CWB9...38	MA90RVS	0.025
MPW12 MPW18 MPW40		<ul style="list-style-type: none"> - Used for star-delta starters; - Adapter fixed by screws or DIN rail 35 mm; - 90 mm width; - Motor protective circuit breaker + contactors: connection by cables; - Engineering plastic material. 	CWC07...25 CWM9...25 CWB9...38	MA90SDS	0.025



Accessories

Three-Phase Feeder Terminal - FTBBS, LST25 and LST65

For use with	Illustrative picture	Description	Reference code	Weight kg
MPW18		<ul style="list-style-type: none"> - For feeding the busbars - Rated insulation voltage: 690 V ac - I_n: 63 A - Terminals: 6-25 mm² rigid wire and 6-16 mm² flexible wire with terminal 	FTBBS	0.042
MPW40		<ul style="list-style-type: none"> - Block module for " Type E" Combination motor Controller" in accordance with UL (LST25+MPW+TSB) - Rated insulation voltage: 690 V ac - I_n: 63 A - Terminals: 8-20 AWG 	LST25	0.042
MPW80		<ul style="list-style-type: none"> - Block module for " Type E" Combination motor Controller" in accordance with UL (LST65+MPW+TSB) - Rated insulation voltage: 690 V ac - I_n: 63 A - Terminals: 4-8 AWG 	LST65	0.179

Current Limiter - CLT32

For use with	Illustrative picture	Description	Reference code	Weight kg
MPW40		<ul style="list-style-type: none"> - For protecting electrical circuits where high short-circuit breaking capacity is required: 100 kA @ 500 V ac. <p><i>Note: This accessory must be used together with a MPW40 motor protective circuit breaker up to 32 A.</i></p>	CLT32	0.310

Three-Phase Busbars for Circuit Breakers Without Side Fitted Auxiliary Contacts - BBS45

For use with	Illustrative picture	Description	Number of circuit breakers	Reference code	Weight kg
MPW18 MPW40		<ul style="list-style-type: none"> - For parallel blocking of side-by-side mounted circuit breakers; - Without side auxiliary contacts; - Enables the use of frontal auxiliary contact block ACBF-11; - Rated insulation voltage: 690 V ac; - $I_n = 63$ A. 	2	BBS45-2	0.044
			3	BBS45-3	0.071
			4	BBS45-4	0.102
			5	BBS45-5	0.122



Accessories

Three-Phase Busbars for Motor Protective Circuit Breakers with Side Fitted Auxiliary Contacts - BBS54

For use with	Illustrative picture	Description	Number of circuit breakers	Reference code	Weight kg
MPW18 MPW40		<ul style="list-style-type: none"> - For parallel connection of circuit breakers with screw terminals mounted side-by-side; - Enables the use of side auxiliary contact block ACBS mounted on each motor protective circuit breaker; - Rated Insulation Voltage: 690 V ac; - Ie = 63 A. 	2	BBS54-2	0.047
			3	BBS54-3	0.077
			4	BBS54-4	0.102
			5	BBS54-5	0.134

Shrouded for Unused Terminals - CSD

For use with	Illustrative picture	Description	Reference code	Weight kg
BBS45 and BBS54		Protection against direct contact in energized terminals without the use of busbars BBS.	CSD	0.020

Scale Cover - SCMP

For use with	Illustrative picture	Description	Reference code	Weight kg
MPW12 MPW18 MPW40 MPW80		Protects the current adjustment dial against direct contact while enabling the adjusted current to be viewed.	SCMP	0.005

Push-In-Lugs - PLMP

For use with	Illustrative picture	Description	Reference code	Weight kg
MPW12 MPW18 MPW40 MPW80		For direct assembly of motor protective circuit breaker into any surface using screws.	PLMP	0.005

Technical Data

Models		MPW12	MPW18	MPW12i	MPW18i
Maximum rated current $I_{n,max}$ (Ie)		12 A	18 A	12 A	18 A
Number of poles		3			
Short-circuit release		13 x $I_{e,max}$			
Rated operational voltage U_e		690 V ¹⁾			
Rated frequency		50/60 Hz			
Rated insulation voltage U_i		690 V			
Rated impulse withstand voltage U_{imp}		6 kV			
Use category	IEC 60947-2 (circuit breaker)	A			
	IEC 60947-4-1 (motor starter)	AC-3			
Tripping test		Yes			
Overload protection		Yes		No	
Phase failure sensitivity (IEC 60947-4-1)		Yes		No	
Tripping indication		No			
Tripping class (IEC 60947-4-1)		10		-	
Maximum operation per hour	Operations/hour	15			
Altitude (m)		2,000			
Degree of protection (IEC 60529)		IP20			
Mechanical life	Number of operations	100,000			
Electrical life	Number of operations	100,000			
Permissible ambient temperature					
Transport and storage		-50...+80 °C			
Operation ²⁾		-20...+70 °C			
Temperature compensation (IEC 60947-4-1)		-20...+60 °C		-	
Power dissipation per circuit breaker					
Maximum rated currents I_n	≤ 4 A	7 W			
	≤ 10 A	8 W			
	≤ 12 A ³⁾	10 W	-	10 W	-
	≤ 16 A	-	14 W	-	14 W
	≤ 18 A	-	12 W	-	12 W
Resistance to impact (IEC 60068-2-27)		15 g			
Standards					
IEC 60947-1		Yes			
IEC 60947-2		Yes			
IEC 60947-4-1		Yes			
Connection					
Type of terminal		Spring	Screws Phillips (Nº 2)	Spring	Screws Phillips (Nº 2)
Tightening torque	N.m	-	1.2...1.7	-	1.2...1.7
	lb.in	-	11...16	-	11...16
Dimensions					
Width (mm)		45			
Height (mm)		100	90	100	90
Depth (mm)		77			

Altitude - Correction Factor

The MPW motor protective circuit breakers do not undergo any change to their specified performance when applied at an altitude of up to 2,000 meters above sea level. However, as the altitude increases, the atmospheric properties vary in terms of dielectric rigidity and pressure. Therefore, current and voltage correction factors must be applied for altitudes exceeding 2,000 meters, as shown in the following table:

Altitude (above sea level) - h	Rated operational voltage U_e	Current correction factor I_u
$h \leq 2,000$ m	690 V	$1 \times I_n$
$2,000 < h \leq 3,000$ m	550 V	$0.96 \times I_n$
$3,000 < h \leq 4,000$ m	480 V	$0.93 \times I_n$
$4,000 < h \leq 5,000$ m	420 V	$0.90 \times I_n$

Notes: 1) 500 V with plastic enclosure;

2) Reduce current for temperatures exceeding +60 °C (87% to 70 °C);

3) Only available with spring terminal.

Technical Data



Referene code		MPW40	MPW40i	MPW40t	MPW80	MPW80i	MPW100
Maximum rated current $I_{n_{max}}$ (I_e)		40 A		20 A	80 A		100 A
Number of poles		3					
Short-circuit release		13 x $I_{e_{max}}$		19 x $I_{e_{max}}$	13 x $I_{e_{max}}$		
Rated operational voltage U_e		690 V ¹⁾					
Rated frequency		50/60 Hz					
Rated insulation voltage U_i		690 V					1,000 V
Rated impulse withstand voltage U_{imp}		6 kV					8 kV
Use category	IEC 60947-2 (circuit breaker)	A					
	IEC 60947-4-1 (motor starter)	AC-3					
Tripping test		Yes					
Overload protection		Yes	No	Yes	No	Yes	Yes
Phase failure sensitivity (IEC 60947-4-1)		Yes	No	Yes	No	Yes	Yes
Tripping indication		Yes					
Tripping class (IEC 60947-4-1)		10	-	10	-	10	10
Maximum operation per hour	Operations/hour	15					25
Altitude (m)		2,000					
Degree of protection (IEC 60529)		IP20					
Mechanical life	Number of operations	100,000			50,000		
Electrical life	Number of operations	100,000			25,000		
Permissible ambient temperature		-50...+80 °C					
Transport and storage		-50...+80 °C					
Operation ²⁾		-20...+70 °C					-20...+60 °C
Temperature compensation (IEC 60947-4-1)		-20...+60 °C	-	-20...+60 °C	-20...+60 °C	-	-20...+60 °C
Power dissipation per circuit breaker							
Maximum rated currents I_n	≤4 A	7 W		-		-	
	≤10 A	8 W		-		-	
	≤16 A	12 W		-		-	
	≤20 A	12 W		-		-	
	≤25 A	15 W		-		-	
	≤40 A	11 W		12		-	
	≤50 A	-		13		-	
	≤65 A	-		13		-	
	≤75 A	-		-		25	
	≤80 A	-		18		-	
≤90 A	-		-		29		
≤100 A	-		-		29		
Resistance to impact (IEC 60068-2-27)		15 g		15		25	
Standards							
IEC 60947-1		Yes					
IEC 60947-2		Yes					
IEC 60947-4-1		Yes					
Connection							
Type of terminal		Screws phillips (N° 2)			Allen (4 mm)		
Tightening torque	N.m	2...2.5			6		
	lb.in	18...22			53		55
Dimensions							
Width (mm)		45		54		70	
Height (mm)		97		125		165	
Depth (mm)		98		157		171	

Notes: 1) 500 V with plastic enclosure.

2) Reduce current for temperatures exceeding +60 °C (87% to 70 °C).

Technical Data

Main Terminal Capacity

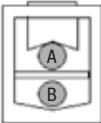
Reference code	Type	Number of conductors	Cross-section	
MPW12	Rigid cable	 1 or 2	1...1.5 mm ² 18...16 AWG	
	Cable without terminal ¹⁾		1...1.5 mm ² 18...16 AWG	
MPW18	Rigid or flexible cable	1 or 2	1...4 mm ² 18...12 AWG	
MPW40	Rigid or flexible cable	1 or 2	1...2.5 mm ² 2.5...6 mm ² 14...8 AWG ¹⁾	
MPW80	Type	1 conductor connection on top only		
	Rigid cable		1...35 mm ²	
	Cable without terminal		1.5...35 mm ²	
	Cable without terminal		1...35 mm ²	
	Flexible cable		1.5...35 mm ² 17...2 AWG	
	Type	1 conductor connection on bottom only		
	Rigid cable		2.5...35 mm ²	
	Cable without terminal		6...35 mm ²	
	Cable without terminal		2.5...35 mm ²	
	Flexible cable		6...35 mm ² 13...2 AWG	
	Type	Connection of 2 conductors		
	Rigid cable		Conductor on top (A)	1...35 mm ²
	Cable without terminal			1.5...35 mm ²
	Cable without terminal			1...35 mm ²
	Flexible cable			1.5...35 mm ² 17...2 AWG
	Type		Conductor on bottom (B)	Cross-section
Rigid cable	2.5...35 mm ²			
Cable without terminal	6...35 mm ²			
Cable without terminal	2.5...35 mm ²			
Flexible cable	6...35 mm ² 13...2 AWG			
MPW100	Type	Number of conductors		
	Rigid cable	1	2.5...70 mm ² 12...2/0 AWG	
		2	2.5...50 mm ² 12...1/0 AWG	
	Rigid cable	1	2.5...50 mm ² 12...1/0 AWG	
		2	2.5...35 mm ² 10...2 AWG	

Auxiliary Contact Blocks - ACB

Reference	ACBF-11 (S)			ACBS-__ (S), TSB			
For use with	MPW12 / MPW18 / MPW40 / MPW80						
Rated insulation voltage U _i	250 V			690 V			
Utilization category	24 V ac	220-230 V ac		24 V ac	230 V ac	400 V ac	690 V ac
AC-15	2 A	0.5 A		6 A	4 A	3 A	1 A
AC-12	2,5 A	2.5 A		10 A	10 A	10 A	10 A
DC-13	24 V dc	48 V dc	60 V dc	24 V dc	110 V dc	220 V dc	440 V dc
	1 A	0.3 A	0.15 A	2 A	0.5 A	0.25 A	0.1 A
Type of terminal	Flat		Spring	Flat		Spring	
Type of screw	Phillips (N° 2)		-	Phillips (N° 2)		-	
Tightening torque	1...1.5 N.m (7...10 lb.in)		-	1...1.5 N.m (7...10 lb.in)		-	
Rigid cable	1 or 2 x (0.5...1.5 mm ²) 1 or 2 x (18...16 AWG)		1 or 2 x (1...1.5 mm ²) 1 or 2 x (18...16 AWG)	1 or 2 x (0.5...1.5 mm ²) 1 or 2 x (0.75...2.5 mm ²)		1 or 2 x (1...1.5 mm ²) 1 or 2 x (18...16 AWG)	
Flexible cable	1 or 2 x (0.75...2.5 mm ²) 1 or 2 x (18...14 AWG)		-	1 or 2 x (0.75...2.5 mm ²) 1 or 2 x (18...14 AWG)		-	
Finely stranded with end sleeve ¹⁾	-		1 or 2 x (1 mm ²) 1 or 2 x (18 AWG)	-		1 or 2 x (1 mm ²) 1 or 2 x (18 AWG)	
Backup fuses gL/gG	10 A						

Technical Data

Auxiliary Contact Block - ACB

Reference code	ACBF-11 MPW100		ACBS-11/ACBS-20/ACBS-02/TSB AT-11 MPW100	
For use with	MPW100			
Utilization category	240 V ac		24 V ac	240 V ac
AC-15	3 A		6 A	4 A
DC-13	24 V dc	220 V dc	24 V dc	220 V dc
	1 A	0.1 A	2 A	0.25 A
Type of screw	Phillips (N°2)			
Tightening torque	0.8...1.2 N.m (7...10 lb.in)			
Rigid cable	1 (0.5...2.5 mm ² / 20...14 AWG)		1 o 2 x (0.5...2.5 mm ² / 20...14 AWG)	
Flexible cable	1 (0.5...4 mm ² / 20...10 AWG) o 2 (0.75...2.5 mm ² / 18...14 AWG)			
Back-up fuses gL/gG	16 A			

Undervoltage Release - URMP

Reference code	URMP	URMP-K_ MPW100
For use with	MPW12 / MPW18 / MPW40 / MPW80	MPW100
Operating voltage (enables cir. breaker switch on)	0.85...1.1xUs	
Non-operating voltage (guarantees circuit breaker switch OFF)	0.7...0.35xUs	
Energization consumption	20.2 VA / 13 W	8.5 VA / 6 W
Consumption	7.2 VA / 2.4 W	3 VA / 1.2 W
Max. opening time	20 ms	
Type of terminal	Flat	
Type of screws	Phillips (N°2)	
Tightening torque	0.8...1.2 N.m (7...10 lb.in)	
Rigid cable	1 o 2 x (0.5...1.5 mm ²). 1 o 2 x (0.75...2.5 mm ²).	1 o 2 x (0.5...2.5 mm ² / 20...14 AWG)
Flexible cable	2 x (18...14 AWG)	1 (0.5...4 mm ² / 20...10 AWG) o 2 x (0.75...2.5 mm ² / 18...14 AWG)
Back-up fuses gL/gG	10 A	

Notes: 1) Mandatory use (finely stranded cable without end sleeve is not allowed).
2) 8 AWG for flexible cable only.

Shunt Release - SRMP

Reference code	SRMP	SRMP-K_ MPW100
For use with	MPW12 / MPW18 / MPW40 / MPW80	MPW100
Operating voltage (guarantee circuit breaker switch OFF)	0.7...1.1xUs	
Consumption - Energization	20.2 VA / 13 W	8.5 VA / 6 W
Maximum opening time	20 ms	
Type of terminal	Flat	
Type of screw	Phillips (N°2)	
Tightening torque	0.8...1.2 N.m (7...10 lb.in)	
Rigid cable	1 o 2 x (0.5...1.5 mm ²). 1 o 2 x (0.75...2.5 mm ²).	1 o 2 x (0.5...2.5 mm ² / 20...14 AWG)
Flexible cable	2 x (18...14 AWG)	1 (0.5...4 mm ² / 20...10 AWG) o 2 x (0.75...2.5 mm ² / 18...14 AWG)
Back-up fuses gL/gG	10 A	

Mounting Configurations for MPW Motor Protective Circuit Breaker

Live or Grounded Parts Distance to the Circuit Breaker

Description	U _e	Minimum distance between the circuit breaker and live or grounded parts (mm)		
		A	B	C
MPW12 / MPW18	Up to 690 V	9	20	75
MPW40	Up to 500 V	9	30	95
	Up to 690 V	30	50	95
MPW80	Up to 690 V	10	50	150
MPW100	Up to 690 V	30	150	167

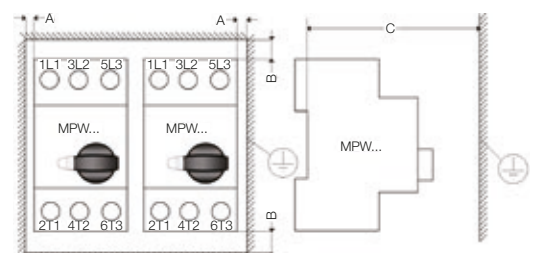

Note: the motor protective circuit breaker can be mounted in any position, but according to IEC 60447 standard, the "On - I" indicator must be to the right, or up.

Technical Data

DC Operation

The MPW12, MPW18, MPW40 and MPW80 can also be used for operating continuous current loads. For such operation it is necessary to connect 2 or 3 poles in series. See recommended circuits and their voltage limits in the table on the right.

Short-circuit breaking capacity $I_{cu} = 10 \text{ kA}$ for all configurations.

Circuits	Máx. V dc	Notes
	150 V dc	System not grounded; 2 pole series connected
	300 V dc	System grounded; 2 pole series connected
	450 V dc	System grounded; 3 pole series connected

Rated Short-Circuit Breaking Capacity (IEC 60947-2)

MPW12 / MPW18 / MPW40 / MPW80 / MPW100

Models reference	Maximum current (A)	220-230 V ac			380-415 V ac			440 V ac			460-500 V ac			630-690 V ac			
		I_{cu}	I_{cs}	Max. fuse (gL/gG)	I_{cu}	I_{cs}	Max. fuse (gL/gG) ¹⁾	I_{cu}	I_{cs}	Max. fuse (gL/gG) ¹⁾	I_{cu}	I_{cs}	Max. fuse (gL/gG) ¹⁾	I_{cu}	I_{cs}	Max. fuse (gL/gG) ¹⁾	
		kA	kA	A	kA	kA	A	kA	kA	A	kA	kA	A	kA	kA	A	
MPW18	MPW12	0.16	100	100	-	100	100	-	100	100	-	100	100	-	10	10	-
		0.25	100	100	-	100	100	-	100	100	-	100	100	-	10	10	-
		0.4	100	100	-	100	100	-	100	100	-	100	100	-	10	10	-
		0.63	100	100	-	100	100	-	100	100	-	100	100	-	10	10	-
		1	100	100	-	100	100	-	100	100	-	100	100	-	10	10	-
		1.6	100	100	-	100	100	-	100	100	-	100	100	-	10	10	-
		2.5	100	100	-	100	100	-	100	100	-	100	100	-	8	8	25
		4	100	100	-	100	100	-	100	100	-	100	100	-	8	8	35
		6.3	100	100	-	100	100	-	100	100	-	100	100	-	8	8	50
		10	100	100	-	50	10	100	50	10	80	10	10	63	5	5	50
12 ²⁾	100	100	-	10	10	100	10	10	80	10	8	80	4	3	63		
16	100	100	-	10	10	100	10	10	80	10	8	80	4	3	63		
18	100	100	-	10	10	100	10	10	80	10	8	80	4	3	80		
MPW40	0.16	100	100	-	100	100	-	100	100	-	100	100	-	100	100	-	
	0.25	100	100	-	100	100	-	100	100	-	100	100	-	100	100	-	
	0.4	100	100	-	100	100	-	100	100	-	100	100	-	100	100	-	
	0.63	100	100	-	100	100	-	100	100	-	100	100	-	100	100	-	
	1	100	100	-	100	100	-	100	100	-	100	100	-	100	100	-	
	1.6	100	100	-	100	100	-	100	100	-	100	100	-	100	100	-	
	2.5	100	100	-	100	100	-	100	100	-	100	100	-	8	8	25	
	4	100	100	-	100	100	-	100	100	-	100	100	-	8	8	35	
	6.3	100	100	-	100	100	-	100	100	-	100	100	-	8	8	50	
	10	100	100	-	100	100	-	50	25	80	42	21	63	8	8	50	
	16	100	100	-	50	25	100	50	15	80	10	8	80	5	5	63	
	20	100	100	-	50	25	125	50	15	80	10	8	80	5	5	80	
	25	100	100	-	50	25	125	50	15	100	10	8	100	5	5	100	
	32	100	100	-	50	25	125	25	15	100	10	8	125	5	5	125	
40	100	100	-	30	15	125	20	10	100	10	5	125	5	2	125		
MPW80	40	100	100	-	65	65	160	65	65	125	35	35	125	8	8	63	
	50	100	100	-	65	65	160	65	65	160	35	35	160	8	8	160	
	65	100	100	-	65	65	200	65	65	200	35	35	200	8	8	200	
	80	65	65	124	65 ³⁾ / 25 ⁴⁾	25 ³⁾ / 10 ⁴⁾	224	10	10	224	10	10	224	6	6	224	
MPW100	75	100	100	-	75	50	-	50	38	200	12	9	160	6	6	125	
	90	100	100	-	75	50	-	50	38	200	12	9	160	6	6	160	
	100	100	100	-	75	50	-	50	38	200	12	9	160	6	6	160	

Self-protected - No backup fuses required up to 100 kA.

1) In cases where prospective short-circuit current $> I_{cu}$, backup fuses are required.

2) Available only for MPW12 (spring terminal version).

3) $U_e \leq 380 \text{ V}$.

4) $U_e = 400/415 \text{ V}$.

Technical Data

Rated Short-Circuit Breaking Capacity (IEC 60947-2)

MPW40+CLT32

Model	Maximum current (A)	380-415 V ac		440 V ac		460-500 V ac		630-690 V ac	
		I _{cu}	I _{cs}	I _{cu}	I _{cs}	I _{cu}	I _{cs}	I _{cu}	I _{cs}
		kA	kA	kA	kA	kA	kA	kA	kA
MPW40 + CLT32	0.16	◆	◆	◆	◆	◆	◆	◆	◆
	0.25	◆	◆	◆	◆	◆	◆	◆	◆
	0.4	◆	◆	◆	◆	◆	◆	◆	◆
	0.63	◆	◆	◆	◆	◆	◆	◆	◆
	1	◆	◆	◆	◆	◆	◆	◆	◆
	1.6	◆	◆	◆	◆	◆	◆	◆	◆
	2.5	◆	◆	◆	◆	◆	◆	50	50
	4	◆	◆	◆	◆	◆	◆	50	50
	6.3	◆	◆	◆	◆	◆	◆	50	50
	10	◆	◆	100	100	100	100	50	50
	16	100	100	100	100	100	100	50	50
	20	100	100	100	100	100	100	50	50
25	100	100	100	100	100	100	10	10	
32	100	100	100	100	100	100	10	10	

MPW80 + MPW80i

Reference code	Maximum current (A)	380-415 V ac		440 V ac		460-500 V ac		630-690 V ac	
		I _{cu}	I _{cs}	I _{cu}	I _{cs}	I _{cu}	I _{cs}	I _{cu}	I _{cs}
		kA	kA	kA	kA	kA	kA	kA	kA
MPW80 + MPW80i-3-U080	40	65	65	65	65	65	65	25	25
	50	65	65	65	65	65	65	25	25
	65	65	65	65	65	65	65	25	25
	80	65	65	65	65	65	65	25	25

Self-protected - No backup fuses required up to 100 kA.

◆ Not applicable due to circuit breaker MPW40 already have 100 kA I_{cu} / I_{cs} in related ranges.

Technical Data

Characteristics Curves

The tripping characteristic shows the motor circuit breaker trip time in relation to the rated current.

The curves show average tolerance range values for an ambient temperature of 20 °C, starting in cold state. Thermal trip time when working in operating temperature is reduced to around 25% of the presented values. Under normal operating conditions, all 3 circuit breaker phases must be conducting.

MPW12 / MPW18 / MPW40 / MPW80

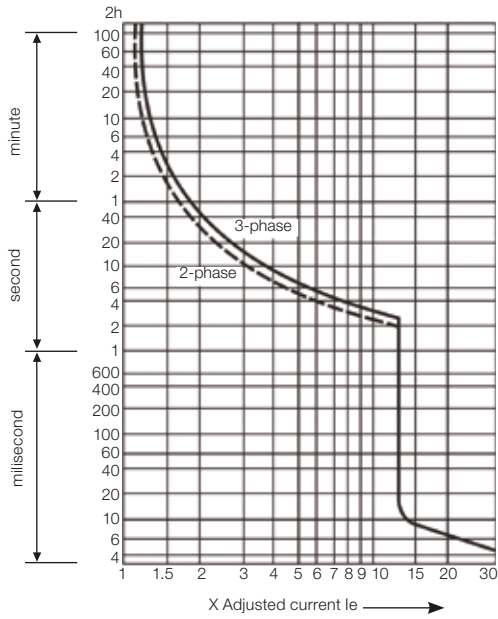

MPW40t

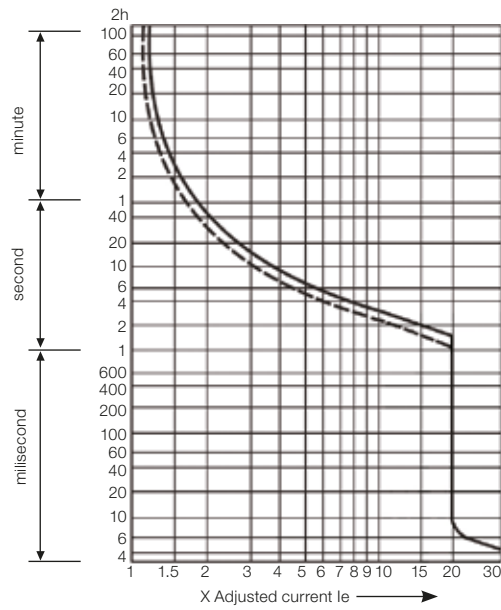

MPW12i / MPW18i / MPW40i / MPW80i

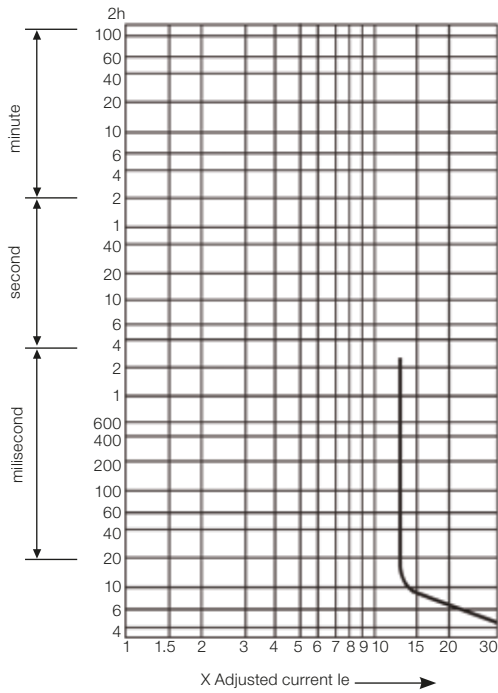

MPW100

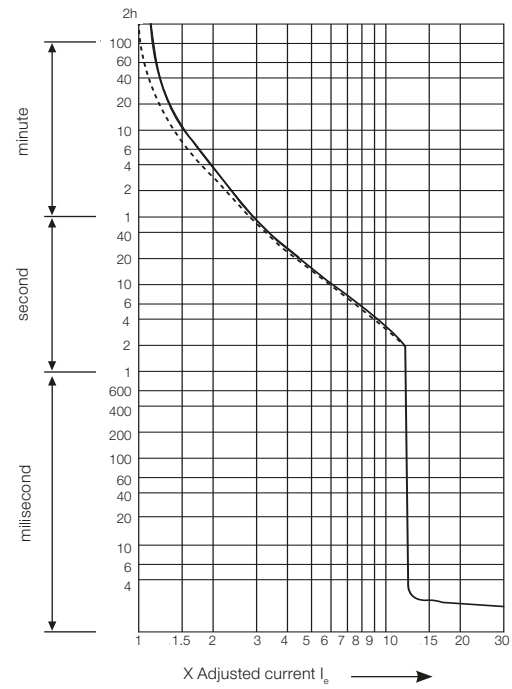

Technical Data

Characteristics Curves

I²t at 415 V - MPW12 / MPW18

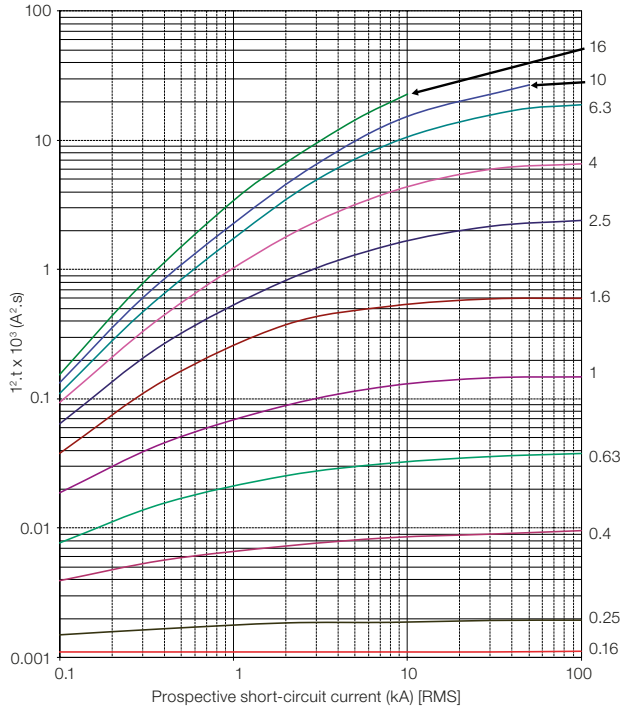

I²t at 415 V - MPW40

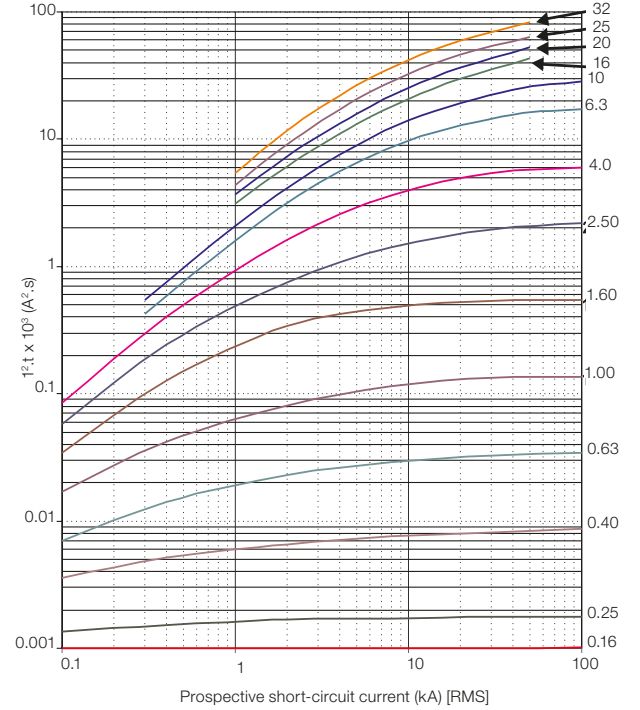

I²t at 415 V - MPW80

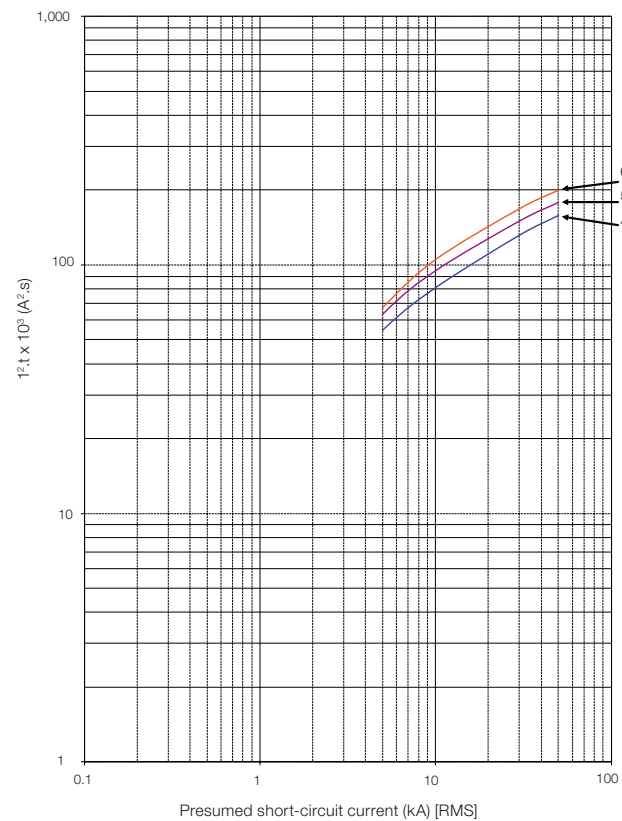

Technical Data

Characteristics Curves

Short-Circuit Current Limitation Curve at 400/415 V - MPW40

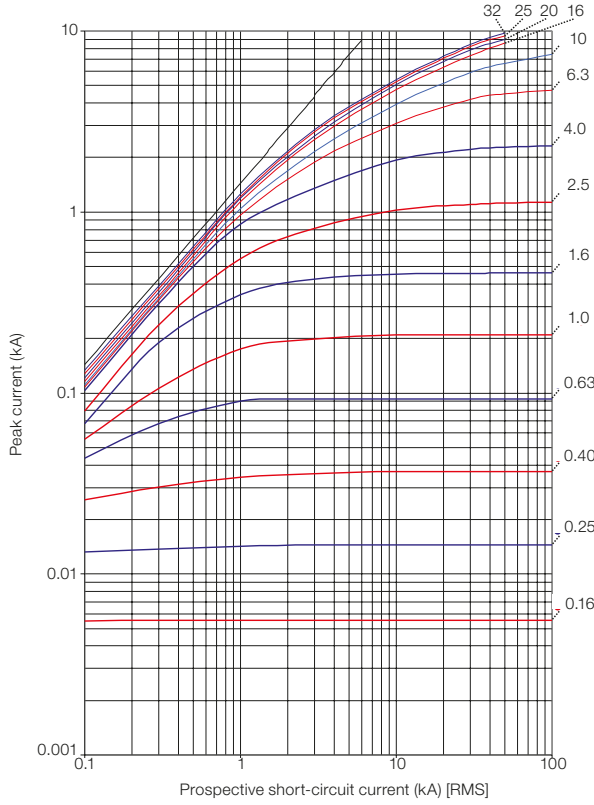

Short-Circuit Current Limitation Curve at 440 V - MPW40

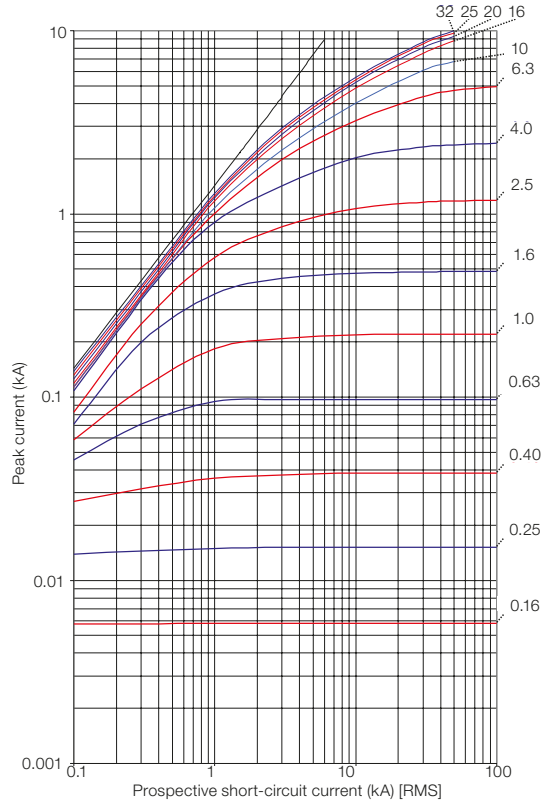

Short-Circuit Current Limitation Curve at 500 V - MPW40

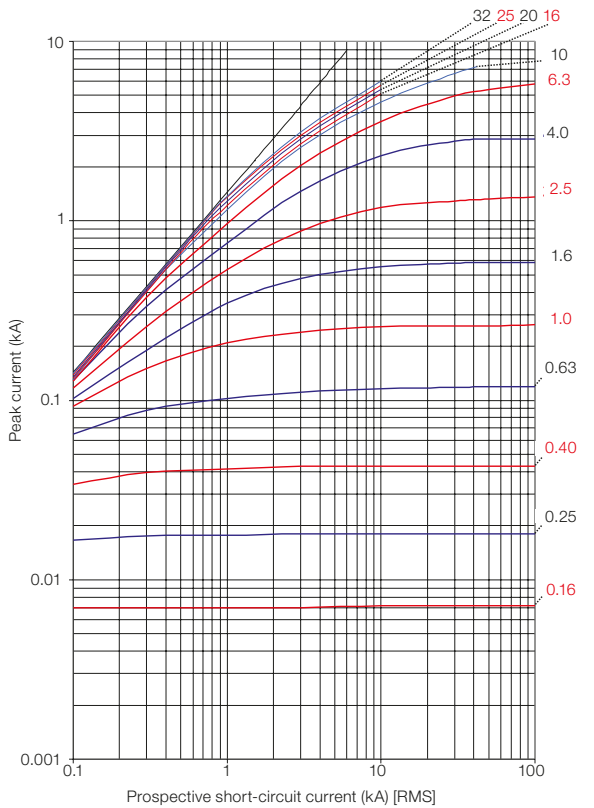

Diagrams and Typical Circuits

Diagrams

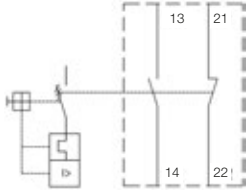
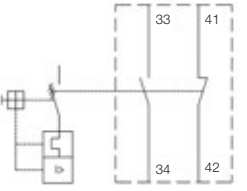
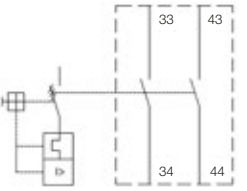
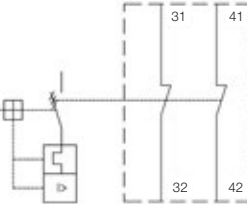
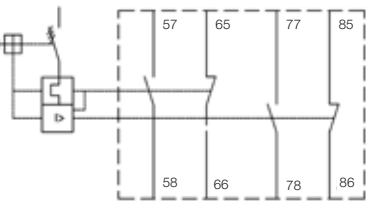
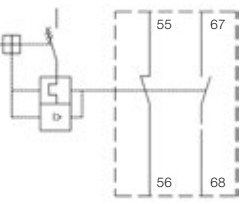
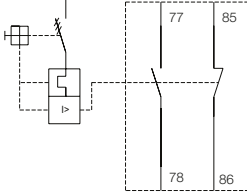
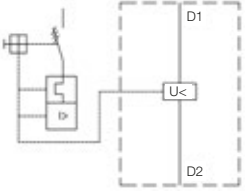
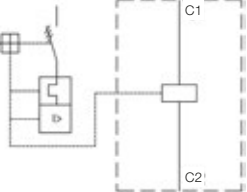
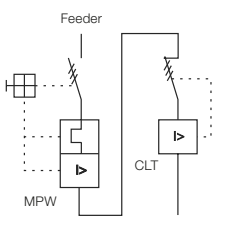
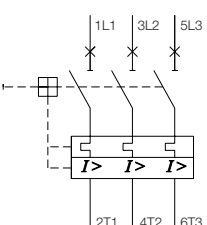
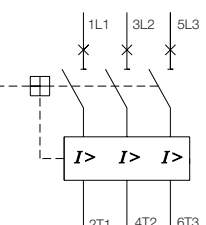
<p>ACBF-11 and ACBF 11 MPW100</p> 	<p>ACBS-11 and ACBS-11-MPW100</p> 	<p>ACBS-20 and ACBS-20-MPW100</p> 
<p>ACBS-02 and ACBS-02 MPW100</p> 	<p>TSB</p> 	<p>TSB AT11 MPW100</p> 
<p>TSB SC-11 MPW100</p> 	<p>URMP</p> 	<p>SRMP</p> 
<p>MPW40 + CLT32</p> 	<p>MPW12 / MPW18 / MPW40 / MPW80 / MPW100</p> 	<p>MPW12i / MPW18i / MPW40i / MPW80i</p> 

Typical Circuits

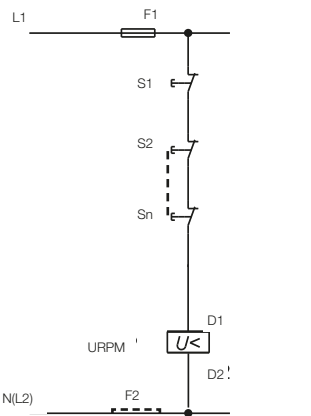
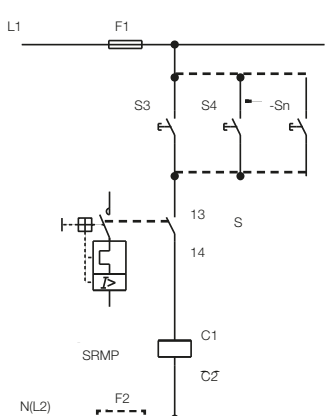
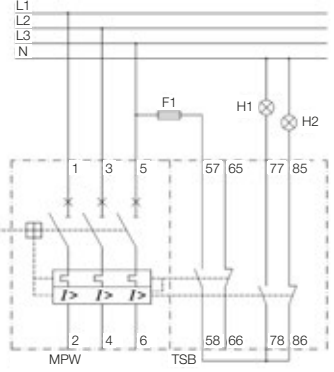
<p>Undervoltage release URPM</p>  <p>S0...Sn - Buttons in the plant (NC) URPM - Undervoltage release</p>	<p>Shunt release SRMP</p>  <p>S0...Sn - Buttons in the plant (NO) S - MPW auxiliary contact</p>	<p>Trip signalling block TSB</p>  <p>H1 - Short-circuit trip signalling H2 - Overcurrent trip signalling MPW - Motor protective circuit breaker thermomagnetic (MPW12 / MPW18 / MPW40 / MPW80)</p>
--	---	--

Diagrams and Typical Circuits

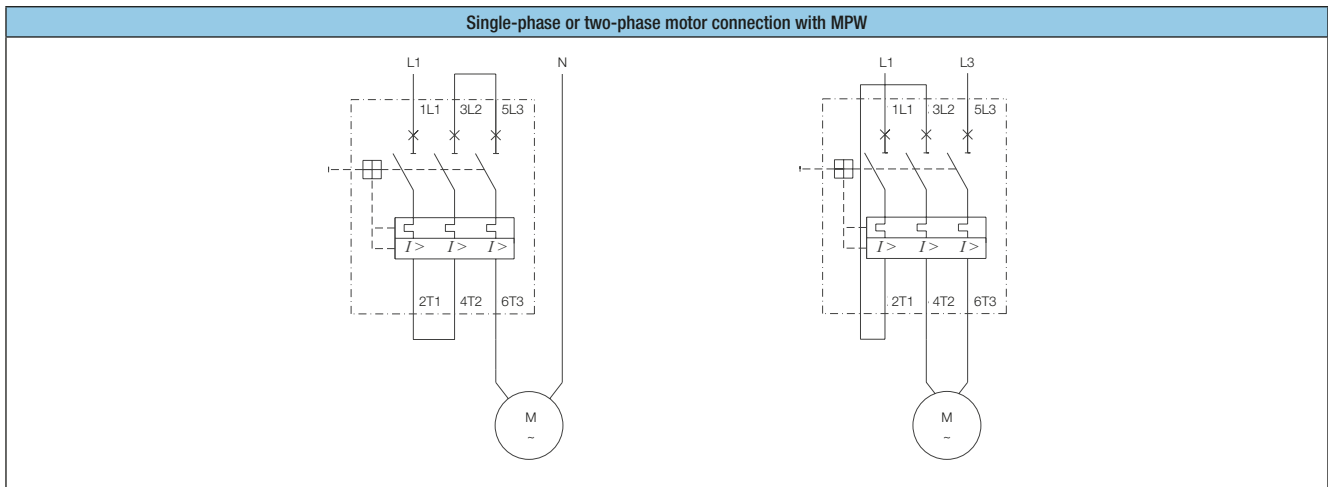

MPW - Dimensions (mm)

MPW18 + Accessories

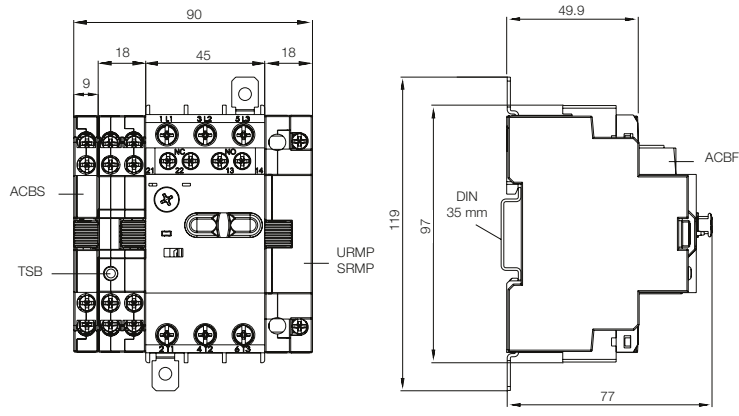

Mounting Position

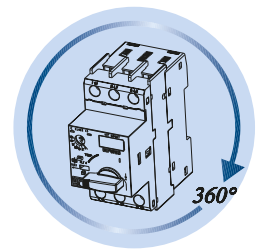

Dimensions (mm)

MPW12 + Accessories

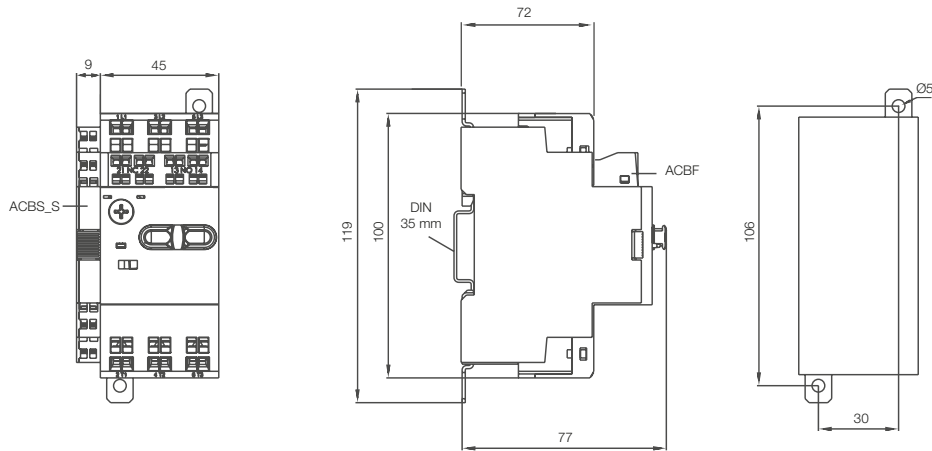

Mounting Position

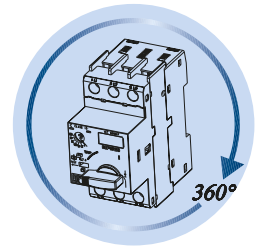

Insulated Enclosure for MPW12/18

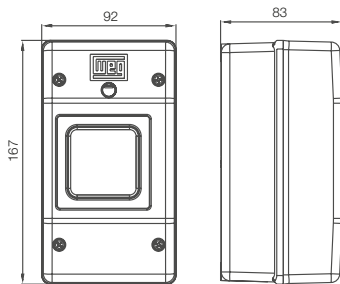

Insulated Enclosure for MPW12/18 + Emergency Stop Button

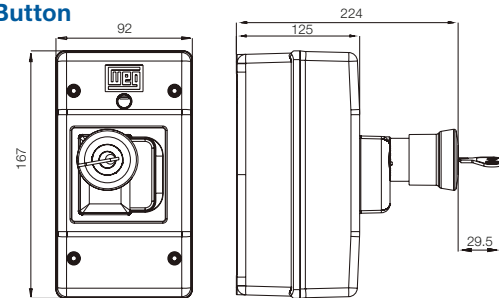

MPW18 + CWC07...16

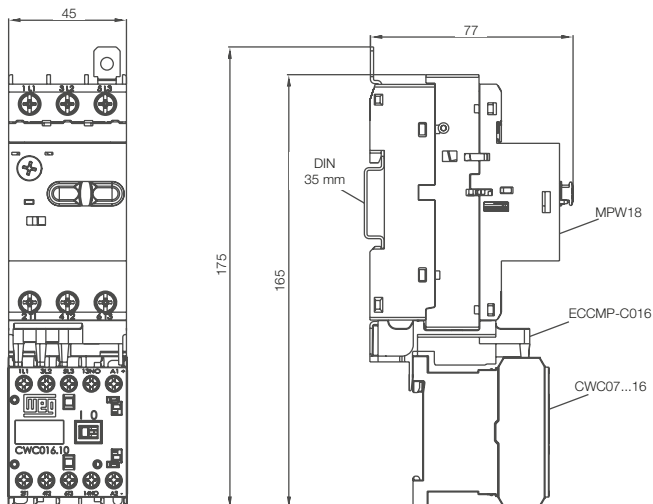

MPW18+CWB9...38

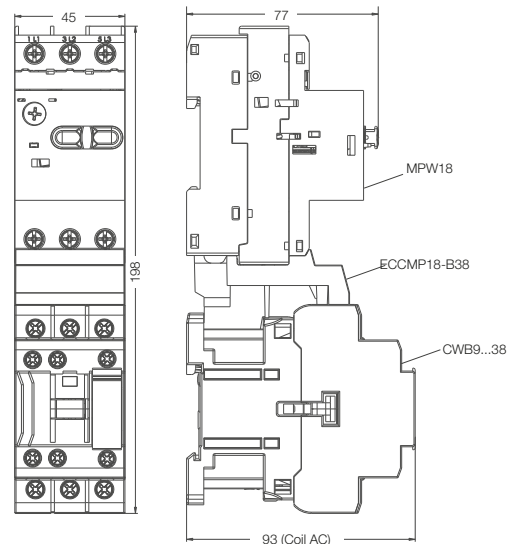

Dimensions (mm)

MPW40 + Accessories

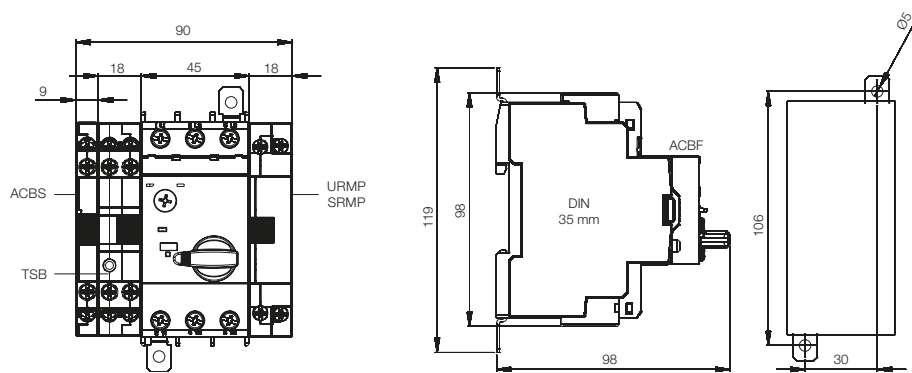

Mounting Position

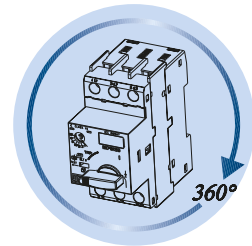

MPW40 + CW07

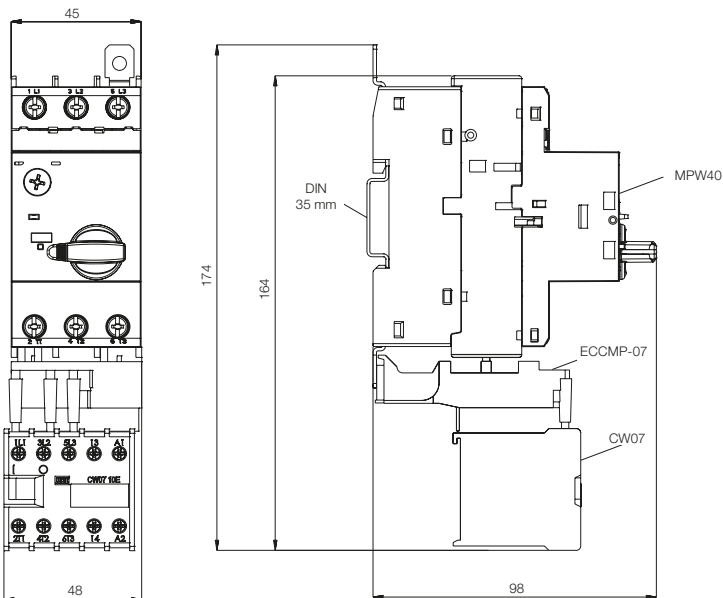

MPW40 + CWC07...16

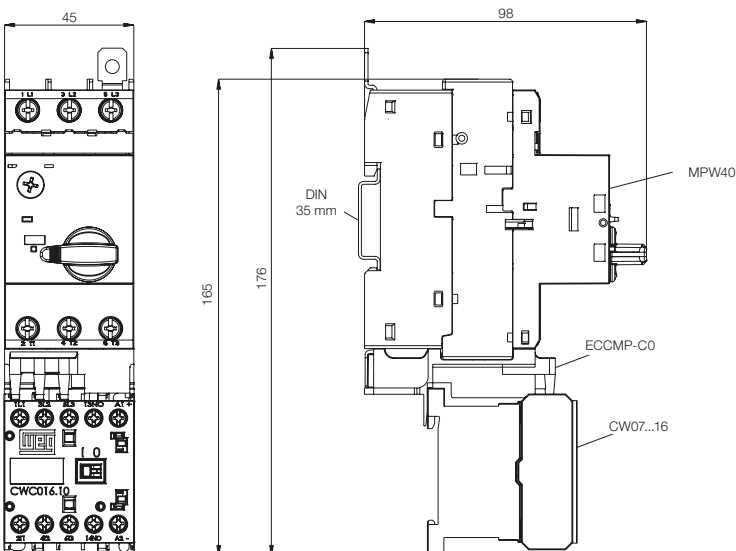

Dimensions (mm)

MPW40 + CWC025

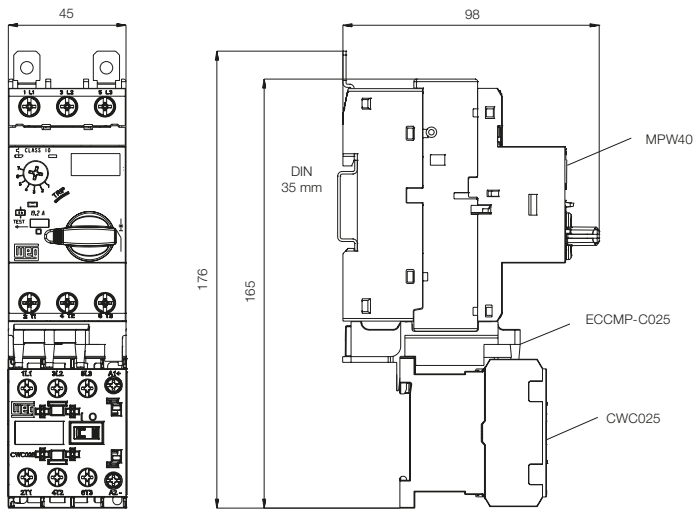

MPW40 + CWM9...18

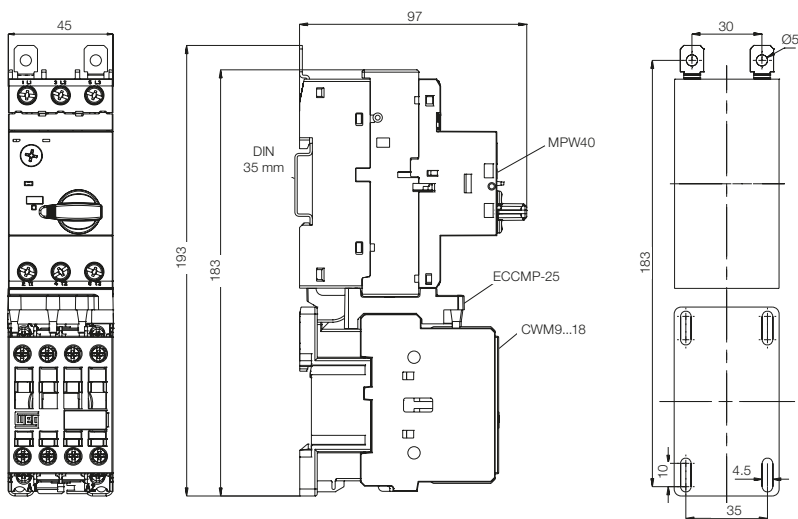

MPW40 + CWM25

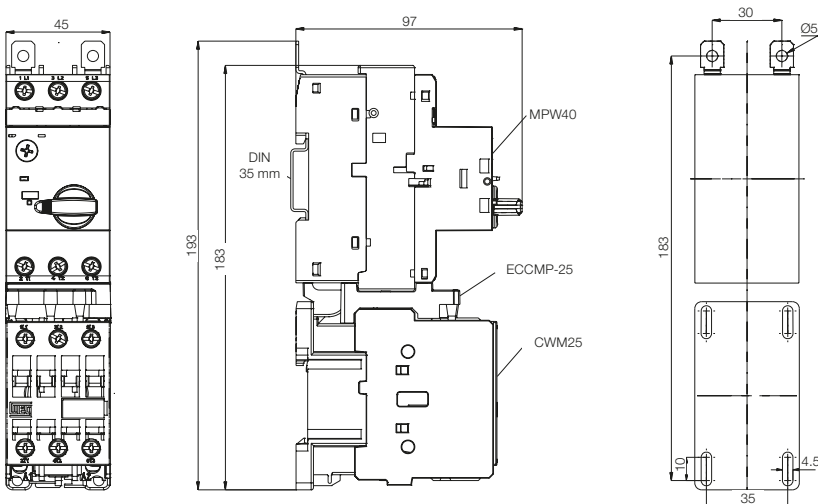

Dimensions (mm)

MPW40 + CWM32

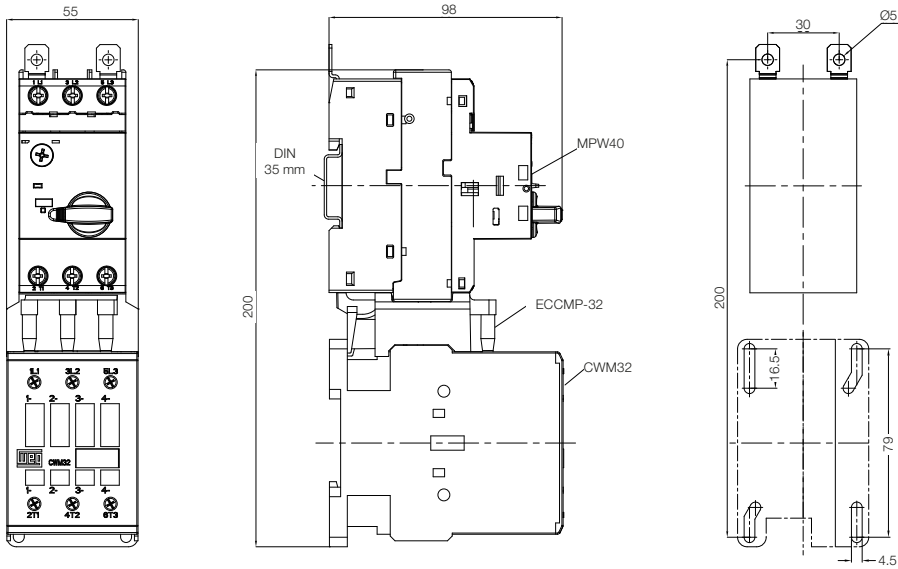

MPW40 + CWB9...38

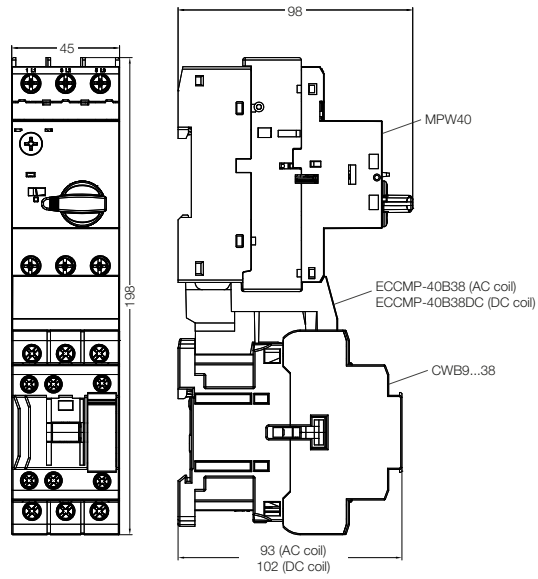

Current Limiter - CLT32

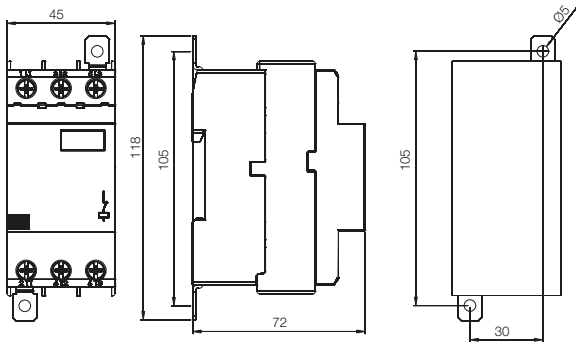

Dimensions (mm)

Front Plate - FME55

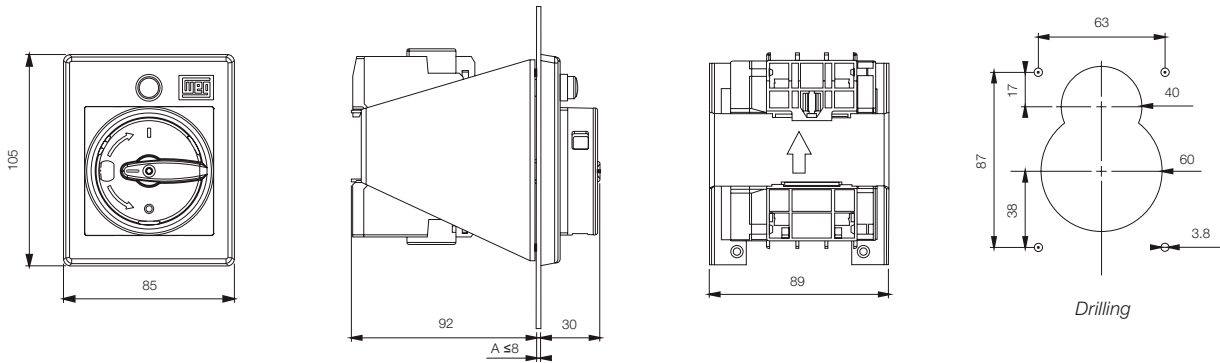

Insulated Enclosure - MPE55/PE55 (IP55)

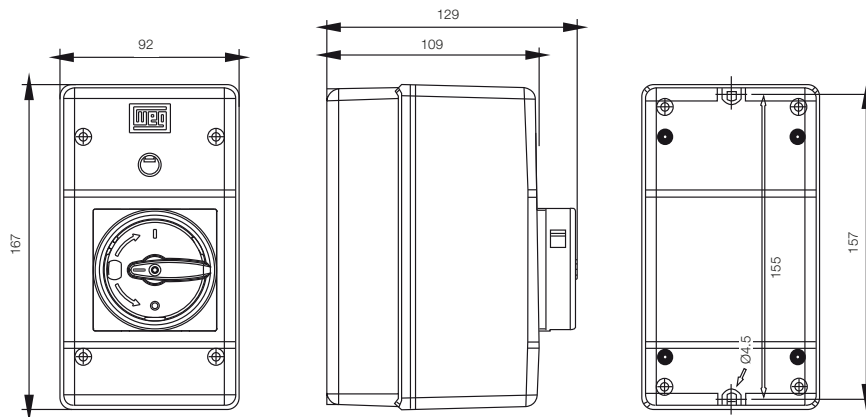

Insulated Enclosure - MLPE55/LPE55 (IP55)

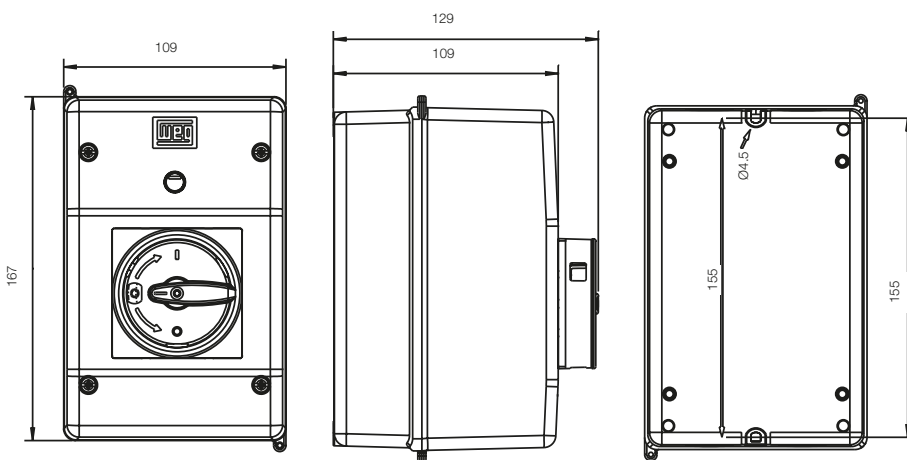

Dimensions (mm)

Motor Protective Circuit Breaker Mounting Adapters + Contactor - MA

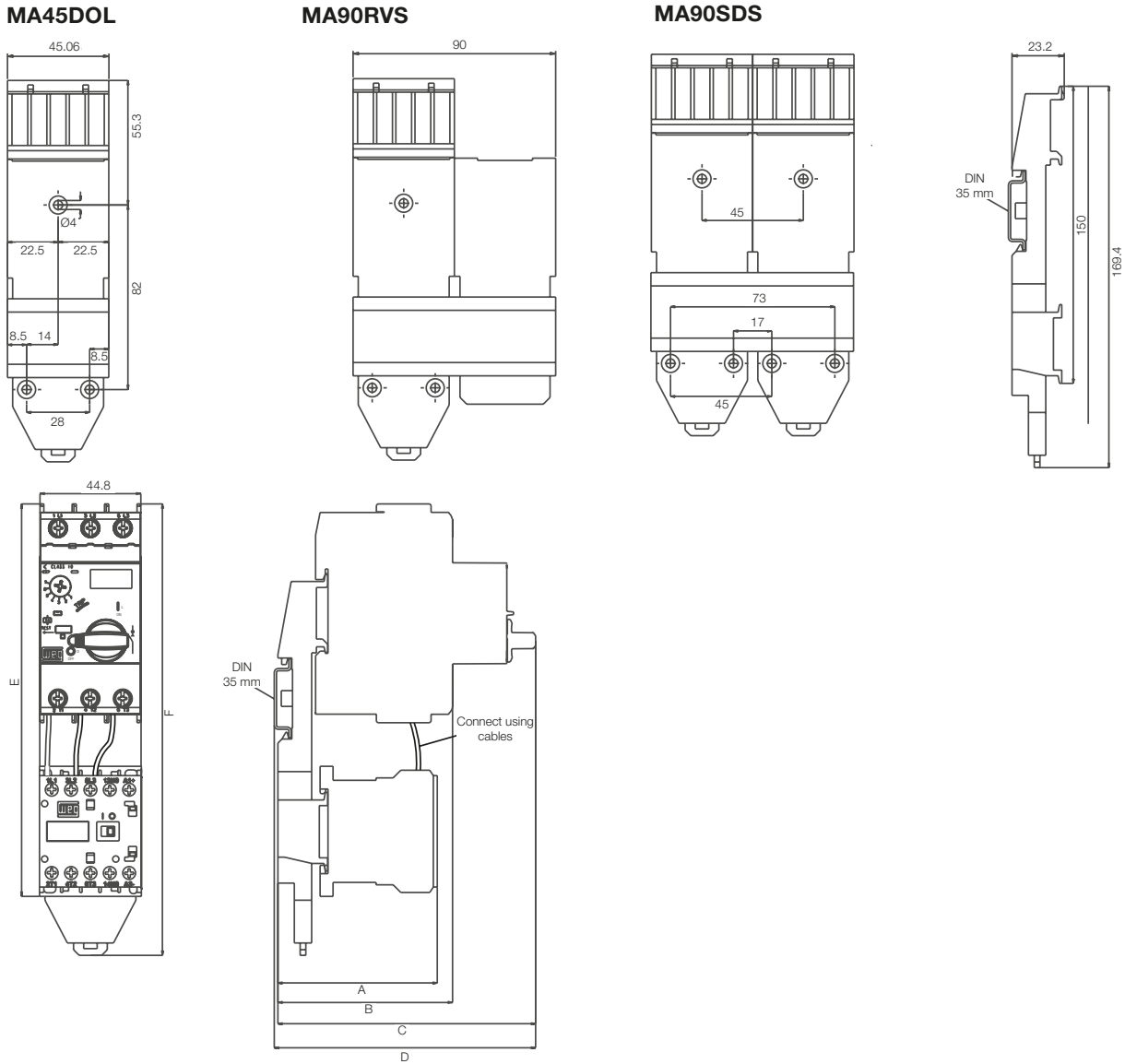

Contactors									
MPW12/18	CW07	CWC07...016 (coil AC/DC)	CWC025	CWM9...18 (coil AC)	CWM9...18 (coil DC)	CWM25 (coil AC)	CWM25 (coil DC)	CWB9...38 (coil AC)	CWB9...38 (coil DC)
A	63.8	70.8	74.37	102.9	133	104.5	134.6	110.5	120
B	66.7	-	-	-	-	-	-	-	-
C	93.8	93.8	93.8	-	-	-	-	-	-
D	95.4	95.4	95.4	-	-	-	-	-	-
E	178.41	192.81	192.81	203.64	203.64	203.64	203.64	203.64	203.64
F	200.55	200.55	200.55	210.8	210.8	210.8	210.8	210.8	210.8

Contactors									
MPW40	CW07	CWC07...016 (coil AC/DC)	CWC025	CWM9...18 (coil AC)	CWM9...18 (coil DC)	CWM25 (coil AC)	CWM25 (coil DC)	CWB9...38 (coil AC)	CWB9...38 (coil DC)
A	63.8	70.8	74.37	102.9	133	104.5	134.6	110.5	120
B	77.06	77.06	77.06	-	-	-	-	-	-
C	114.5	114.5	114.5	114.5	-	114.5	-	-	-
D	116.1	116.1	116.1	116.1	-	116.1	-	-	-
E	178.41	192.81	192.81	203.64	203.64	203.64	203.64	187	187
F	200.55	200.55	200.55	210.8	210.8	210.8	210.8	210.8	210.8

Dimensions (mm)

Accessories: BBS45, BBS54, FTBBS, LST25, LST65

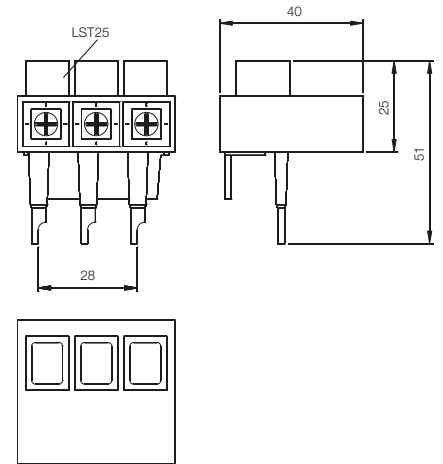
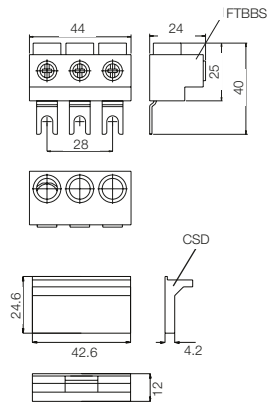
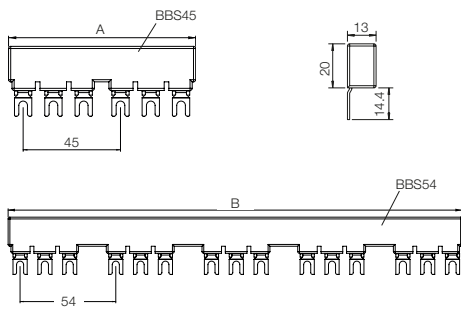

Models	BBS45-2	BBS45-3	BBS45-4	BBS45-5
A	85	130	175	220
Models	BBS54-2	BBS54-3	BBS54-4	BBS54-5
B	94	149	202	256

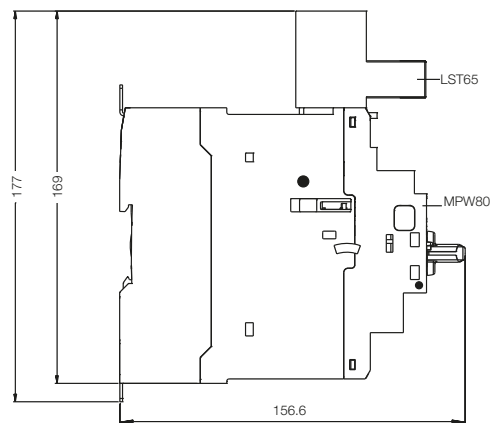
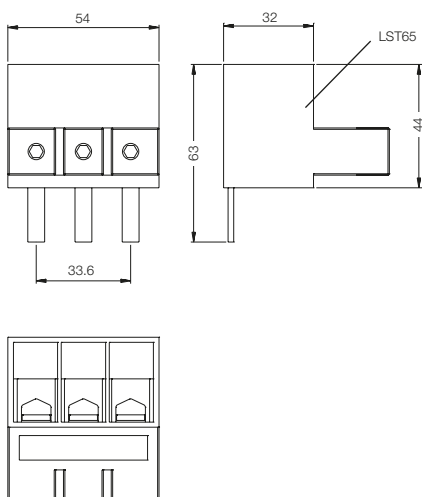
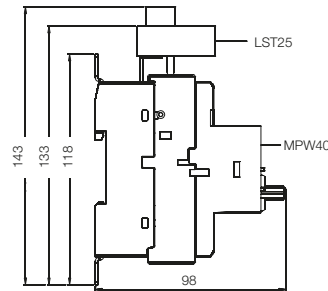
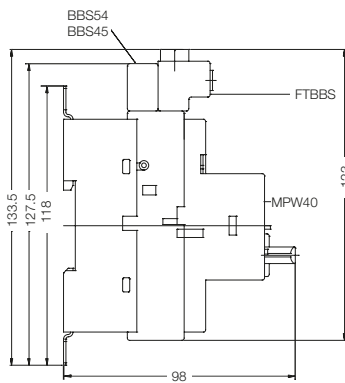

Dimensions (mm)

Door Coupling Rotary Handle - RMMP

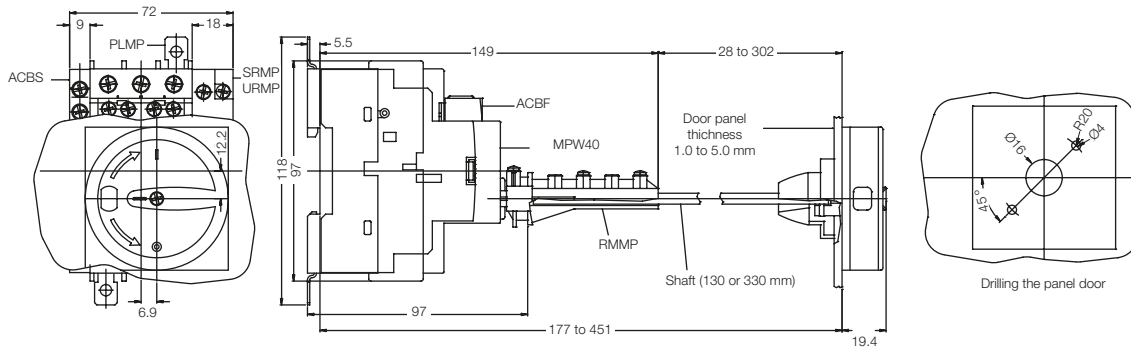

Door Coupling Rotary Handle - MRX

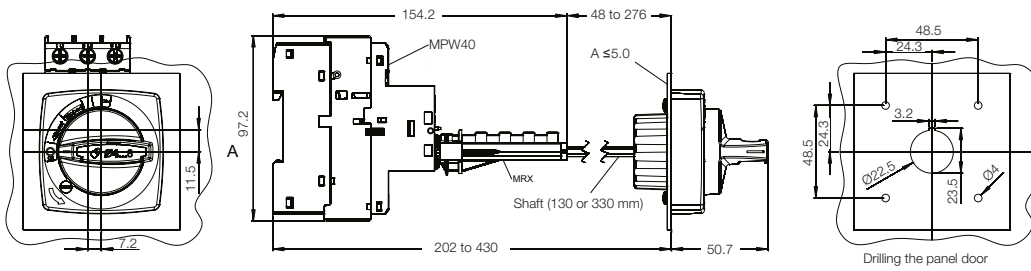

MPW80 + Accessories

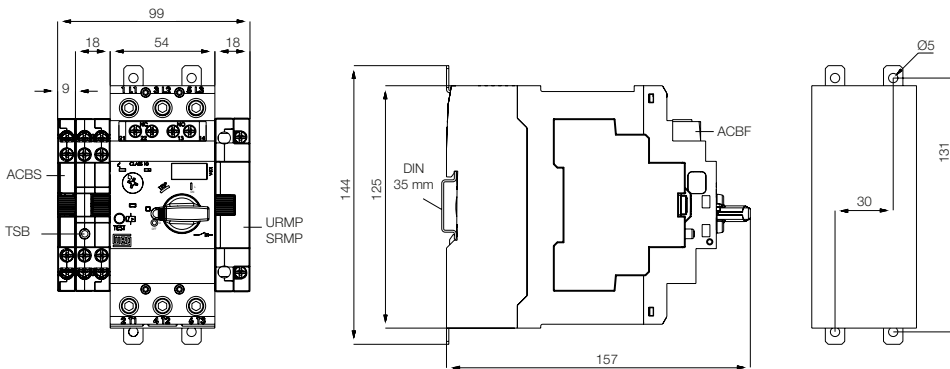

Mounting Position

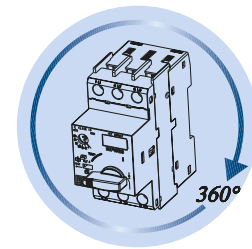

Dimensions (mm)

Door Coupling Rotary Handle - RMMP65

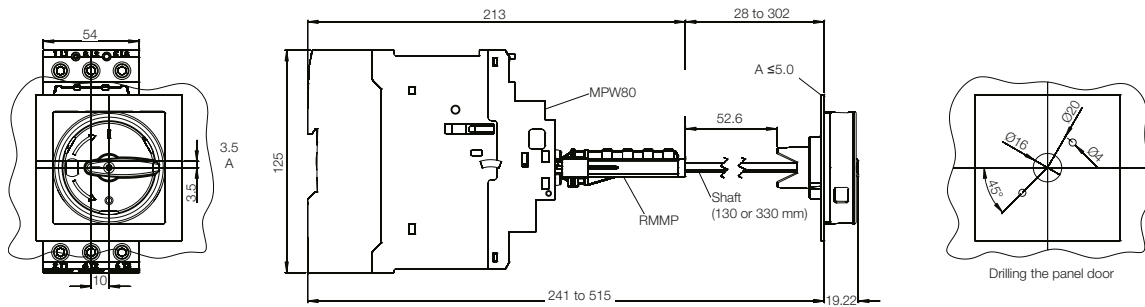

Door Coupling Rotary Handle - MRX65

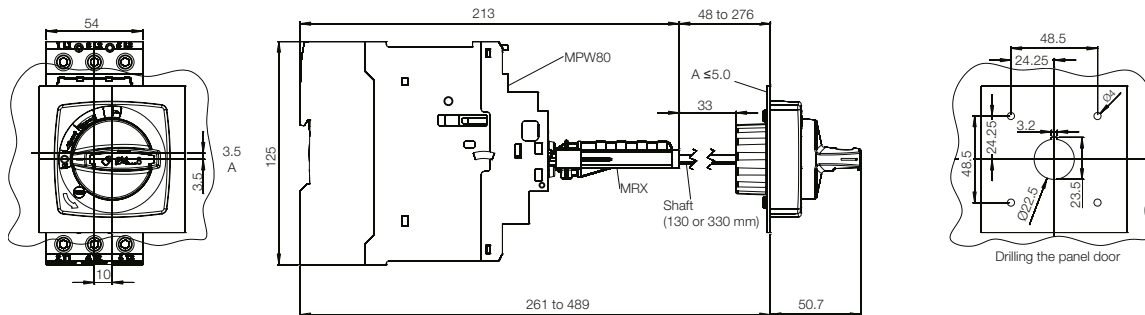

MPW100 + Accessories

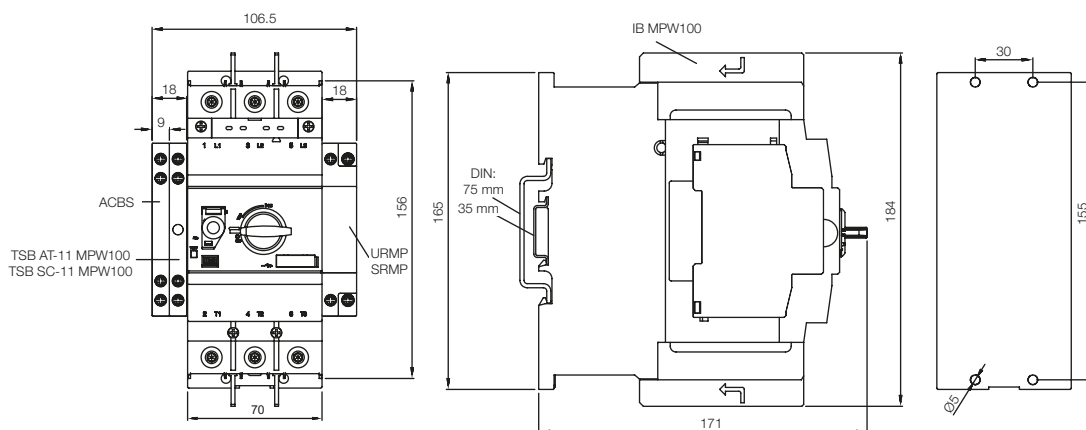

Dimensions (mm)

Door Coupling Rotary Handle - MR MPW100

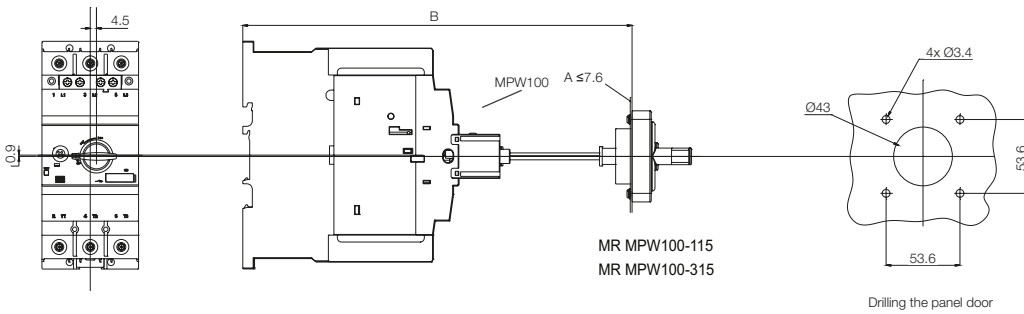

Models	B (mm)
MR MPW100-115	Min.: 220
	Max.: 282
MR MPW100-315	Min.: 220
	Max.: 482

Drilling the panel door

Door Coupling Rotary Handle - MRX100

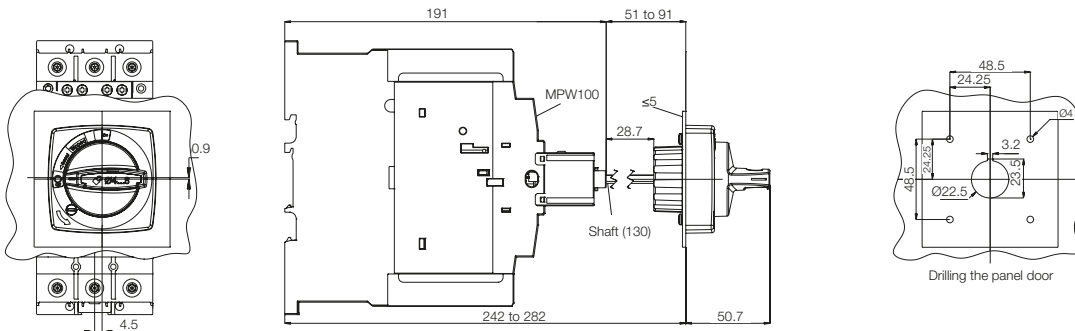

Drilling the panel door

Mounting Position

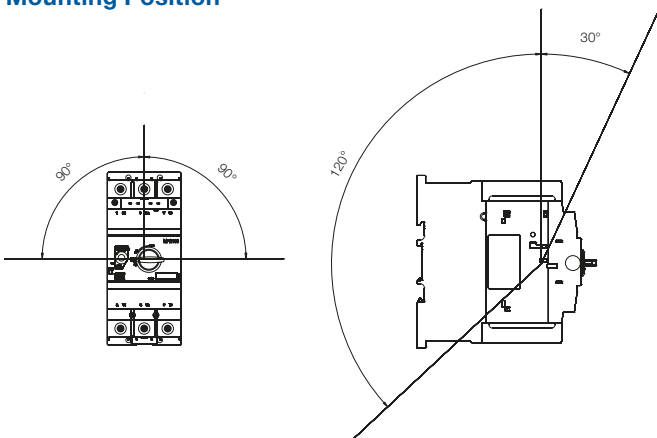



Global presence is essential, as much as understanding your needs.

Global Presence

With more than 30.000 employees worldwide, WEG is one of the largest electric motors, electronic equipments and systems manufacturers. We are constantly expanding our portfolio of products and services with expertise and market knowledge. We create integrated and customized solutions ranging from innovative products to complete after-sales service.

WEG's know-how guarantees our Solutions for Solar Energy is the right choice for your application and business, assuring safety, efficiency and reliability.



Availability is to have a global support network



Partnership is to create solutions that suits your needs



Competitive edge is to unite technology and inovation

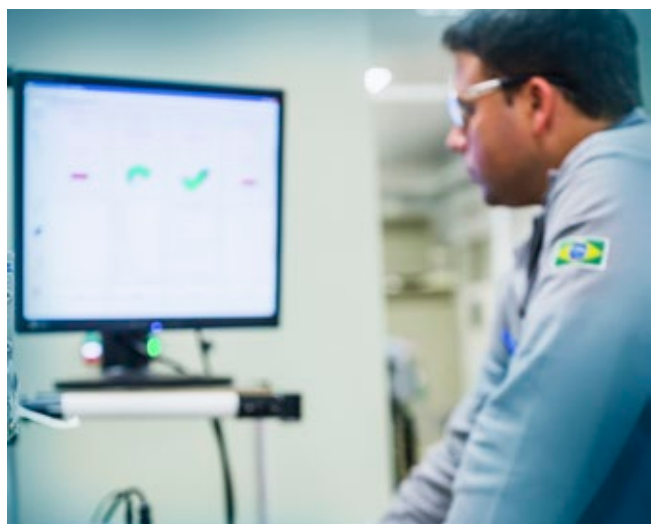

Know More



High performance and reliable products to improve your production process.



Excellence is to provide a whole solution in industrial automation that improves our customers productivity.

Visit: www.weg.net

 youtube.com/wegvideos

WEG Worldwide Operations

ARGENTINA

San Francisco - Cordoba
Phone: +54 3564 421484
info-ar@weg.net

Cordoba - Cordoba
Phone: +54 351 4641366
weg-morbe@weg.com.ar

Buenos Aires
Phone: +54 11 42998000
ventas@pulverlux.com.ar

AUSTRALIA

Scoresby - Victoria
Phone: +61 3 97654600
info-au@weg.net

AUSTRIA

Markt Piesting - Wiener
Neustadt-Land
Phone: +43 2633 4040
watt@wattdrive.com

BELGIUM

Nivelles - Belgium
Phone: +32 67 888420
info-be@weg.net

BRAZIL

Jaraguá do Sul - Santa Catarina
Phone: +55 47 32764000
info-br@weg.net

CHILE

La Reina - Santiago
Phone: +56 2 27848900
info-cl@weg.net

CHINA

Nantong - Jiangsu
Phone: +86 513 85989333
info-cn@weg.net

Changzhou - Jiangsu
Phone: +86 519 88067692
info-cn@weg.net

COLOMBIA

San Cayetano - Bogota
Phone: +57 1 4160166
info-co@weg.net

ECUADOR

El Batan - Quito
Phone: +593 2 5144339
ceccato@weg.net

FRANCE

Saint-Quentin-Fallavier - Isère
Phone: +33 4 74991135
info-fr@weg.net

GERMANY

Türnich - Kerpen
Phone: +49 2237 92910
info-de@weg.net

Balingen - Baden-Württemberg
Phone: +49 7433 90410
info@weg-antriebe.de

Homburg (Efze) - Hesse
Phone: +49 5681 99520
info@akh-antriebstechnik.de

GHANA

Accra
Phone: +233 30 2766490
info@zestghana.com.gh

INDIA

Bangalore - Karnataka
Phone: +91 80 41282007
info-in@weg.net

Hosur - Tamil Nadu
Phone: +91 4344 301577
info-in@weg.net

ITALY

Cinisello Balsamo - Milano
Phone: +39 2 61293535
info-it@weg.net

JAPAN

Yokohama - Kanagawa
Phone: +81 45 5503030
info-jp@weg.net

MALAYSIA

Shah Alam - Selangor
Phone: +60 3 78591626
info@wattdrive.com.my

MEXICO

Huehuetoca - Mexico
Phone: +52 55 53214275
info-mx@weg.net

Tizayuca - Hidalgo
Phone: +52 77 97963790

NETHERLANDS

Oldenzaal - Overijssel
Phone: +31 541 571080
info-nl@weg.net

PERU

La Victoria - Lima
Phone: +51 1 2097600
info-pe@weg.net

PORTUGAL

Maia - Porto
Phone: +351 22 9477700
info-pt@weg.net

RUSSIA and CIS

Saint Petersburg
Phone: +7 812 363 2172
sales-wes@weg.net

SOUTH AFRICA

Johannesburg
Phone: +27 11 7236000
info@zest.co.za

SPAIN

Coslada - Madrid
Phone: +34 91 6553008
wegiberia@wegiberia.es

SINGAPORE

Singapore
Phone: +65 68589081
info-sg@weg.net

Singapore
Phone: +65 68622220
watteuro@watteuro.com.sg

SCANDINAVIA

Mölnlycke - Sweden
Phone: +46 31 888000
info-se@weg.net

UK

Redditch - Worcestershire
Phone: +44 1527 513800
info-uk@weg.net

UNITED ARAB EMIRATES

Jebel Ali - Dubai
Phone: +971 4 8130800
info-ae@weg.net

USA

Duluth - Georgia
Phone: +1 678 2492000
info-us@weg.net

Minneapolis - Minnesota
Phone: +1 612 3788000

VENEZUELA

Valencia - Carabobo
Phone: +58 241 8210582
info-ve@weg.net

For those countries where there is not a WEG own operation, find our local distributor at www.weg.net.



WEG Group - Automation Business Unit
Jaraguá do Sul - SC - Brazil
Phone: +55 47 3276 4000
automacao@weg.net
www.weg.net

