

# Automation

## Thermal Overload Relays RW Line

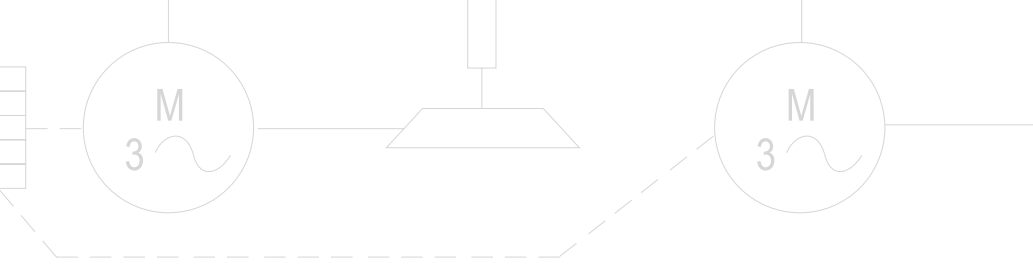

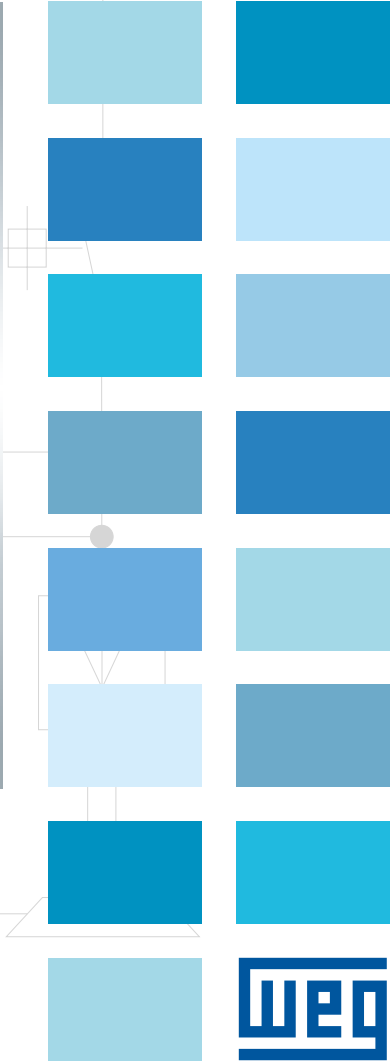
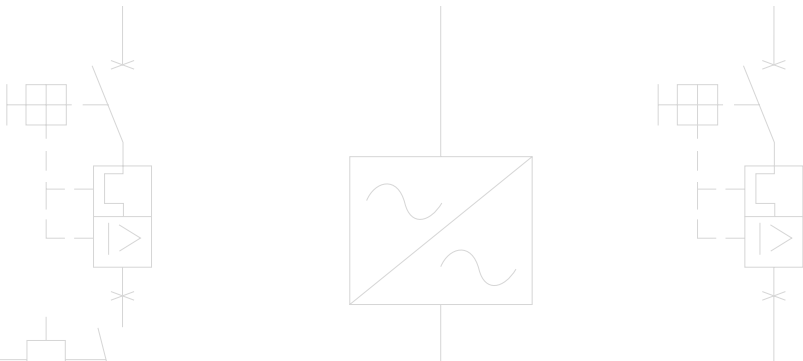
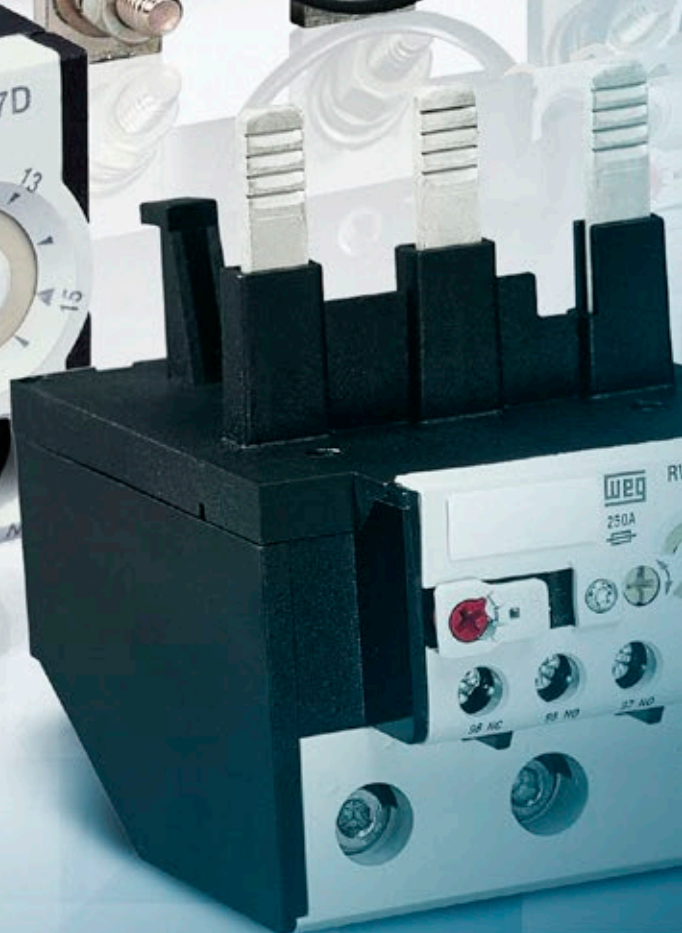
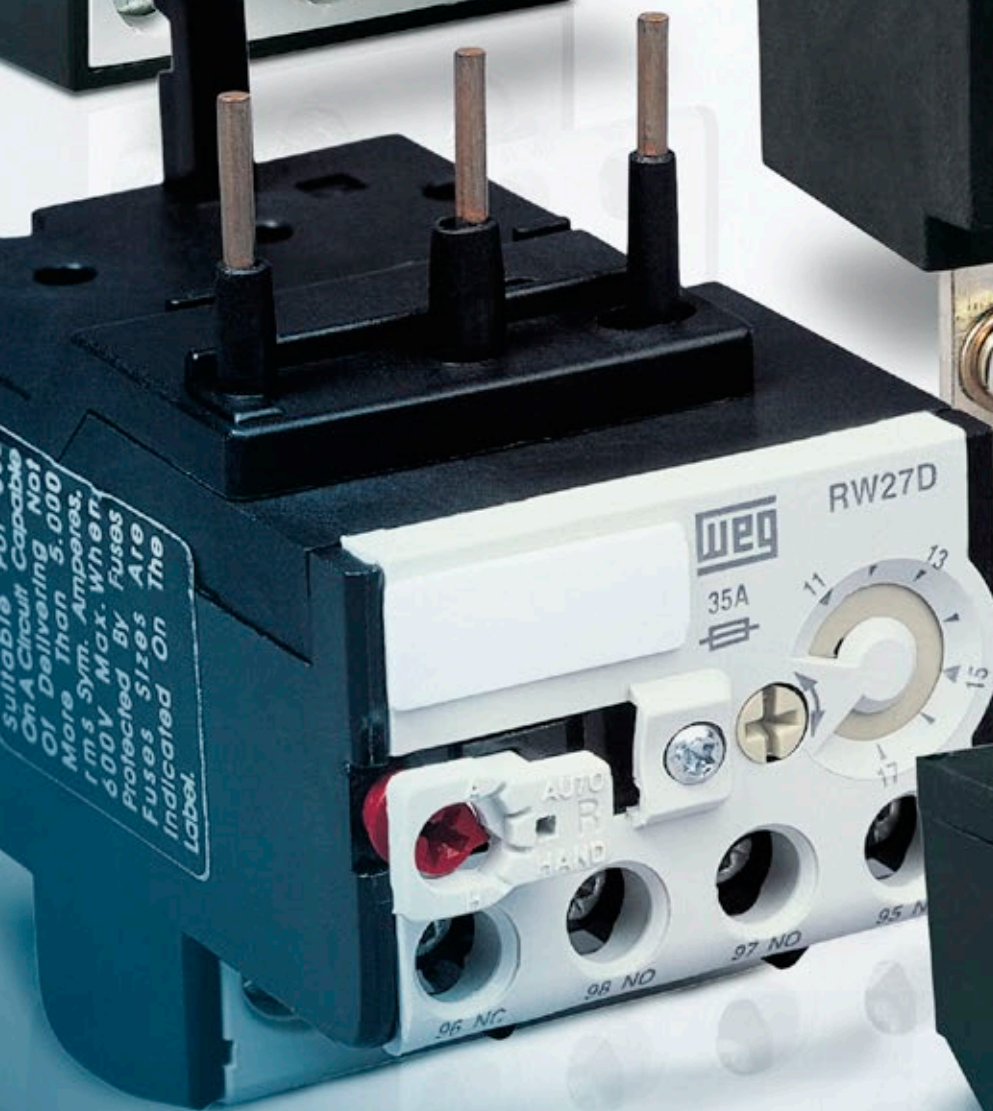
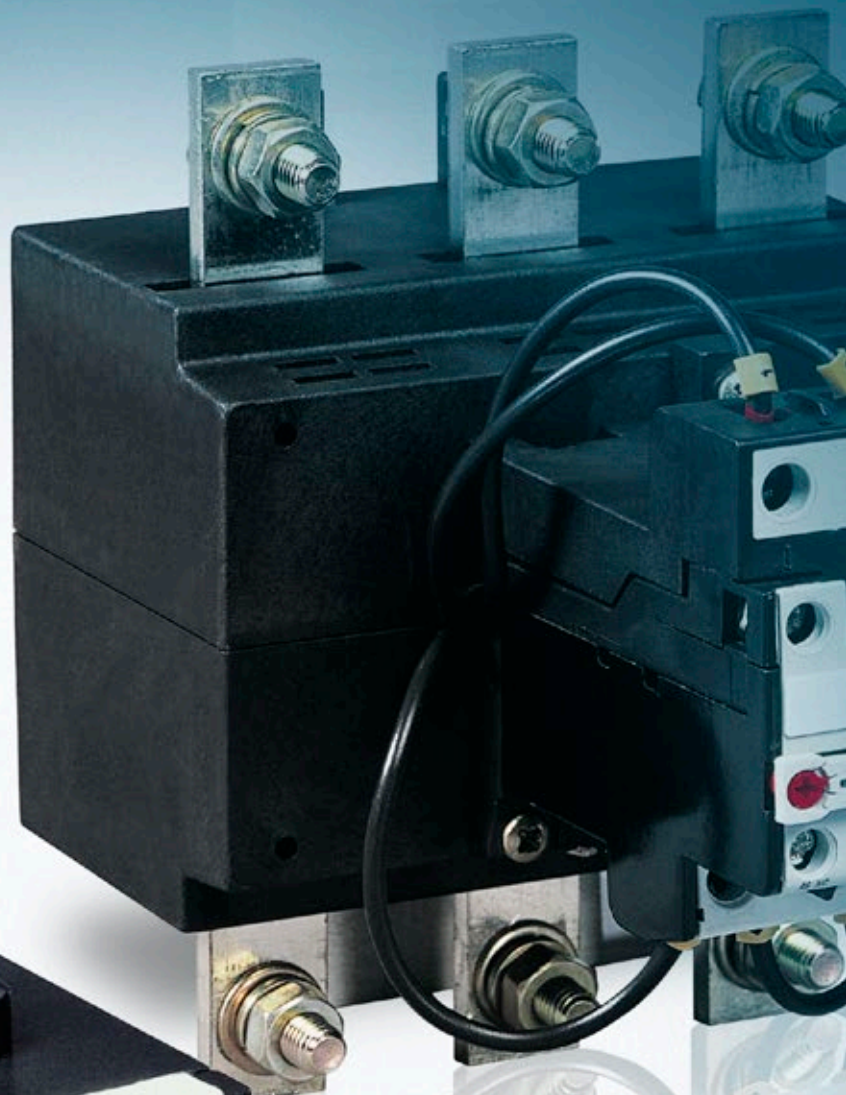

# Thermal Overload Relays RW Line

## Summary

Presentation	04
Thermal Overload Relays RW17...407 - Overview	07
Thermal Overload Relays - From 0.28 to 840 A	08
Accessories	10
Technical Data	11
Diagrams	12
Dimensions (mm)	13





# Thermal Overload Relays RW

## Description

RW thermal overload relays are designed to be combined with contactors to assemble motor starters.

Thermal overload relays are very reliable devices intended to protect motors, controllers and branch-circuit conductors against phase failures and overloads that cause excessive heating.

The thermal overload relay has no power contacts and cannot disconnect the motor by itself. Motor overloads or phase failures increase the motor current. This current increase trips the mechanism and switches the auxiliary contacts.

The auxiliary contacts, when properly wired in series with the coil of the contactor will de-energize the contactor when an overload occurs. Thus, the contactor disconnects the power to the motor and stops its operation. The bimetallic thermal overload relays have thermal memory. Once tripped, the relay will not reset until it has cooled down, allowing the motor to cool before it can be re-started.



## Applications

RW thermal overload relays have been designed to protect three-phase and single-phase AC motors and direct current motors<sup>1)</sup>. When the RW thermal overload relays are intended to protect single-phase AC loads or DC loads, the connection should be made as shown in the diagrams on page 10.

### RW Thermal Overload Relays in Contactor Assemblies for Wye-Delta Starters

When using thermal overload relays in conjunction with contactor assemblies for wye-delta starters, it should be taken into consideration that only  $0.58 (\sqrt{3} / 3) \times$  the motor current flows through the main contactor. An overload relay mounted on the main contactor must be set to the same multiple of the motor current.

A second overload relay may be mounted on the wye contactor if it is desired the load to be optimally protected in wye operation. The wye current is 1/3 of the rated motor current. The relay must then be set to this current.

### Protection Against Short-Circuit

The RW thermal overload relays must be protected against short-circuits by fuses or circuit breakers.

### Ambient Air Temperature Compensation

RW thermal overload relays are temperature compensated. Its trip point is not affected by temperature, and it performs consistently at the same value of current. The time-current characteristics of RWs refer to a stated value of ambient air temperature within the range of -20 °C to +60 °C and are based on no previous loading of the overload relay (i.e. from an initial cold state). For ambient air temperature within the range of +60 °C up +80 °C (maximum ambient air temperature), the current correction factor shown in the table below should be applied:

Ambient air temperature	Current correction factor
65 °C	0.94
70 °C	0.87
75 °C	0.81
80 °C	0.73

*Note: models RW317 and RW407 should be used only with electric motors in alternating current.*

### Site Altitude Compensation

The site altitude and hence the air density play a role with respect to the cooling conditions and dielectric withstand voltage. A site altitude of up to 2,000 m is considered as normal in accordance with IEC/EN 60947. For higher altitudes, the current settings on the thermal overload relay should be higher than the motor rated current. On the other hand, the operational voltage must be reduced.

For site altitudes higher than 2,000 m, the values for the current and voltage shown in the table below should be applied:

Altitude above sea level (m)	Adjustment factor on the current setting	Maximum operational voltage Ue (V)
2,000	$1.00 \times I_n$	690
3,000	$1.05 \times I_n$	550
4,000	$1.08 \times I_n$	480
5,000	$1.12 \times I_n$	420

### Characteristic Tripping Curve

Thermal overload relays are designed to mimic the heat actually generated in the motor. As the motor temperature increases, so does the temperature of the overload relay thermal unit.

The motor and relay heating curves have a strong relationship. No matter how high the current drawn by the motor, the thermal overload relay provides protection and yet, does not trip unnecessarily.

Thus, the characteristic tripping curves indicate how the tripping time, starting from the cold state, varies with the current for multiples of the full-load current for three-pole symmetrical loads.

### Phase Failure Sensitivity

In order to ensure fast tripping in case of phase loss, protecting the motor and avoiding expensive repairs / corrective maintenance services, RW27-2D thermal overload relays include phase failure sensitivity protection as standard. For this purpose, they have a differential release mechanism that, in the case of phase failure, ensures the de-energized cooled down bimetal strip to generate an additional tripping displacement (simulating an overcurrent that actually doesn't exist). This way, in the event of phase failure, the differential release ensures tripping at a lower current than with a three-phase load (characteristic curve below).

However, for more effective protection against phase failure, specific protective products should be evaluated ensuring that such failure is detected much faster. The curve below shows the tripping time in relation to the rated current. It is also considered average values of the tolerance range and at ambient temperature of 20 °C starting from the cold state.

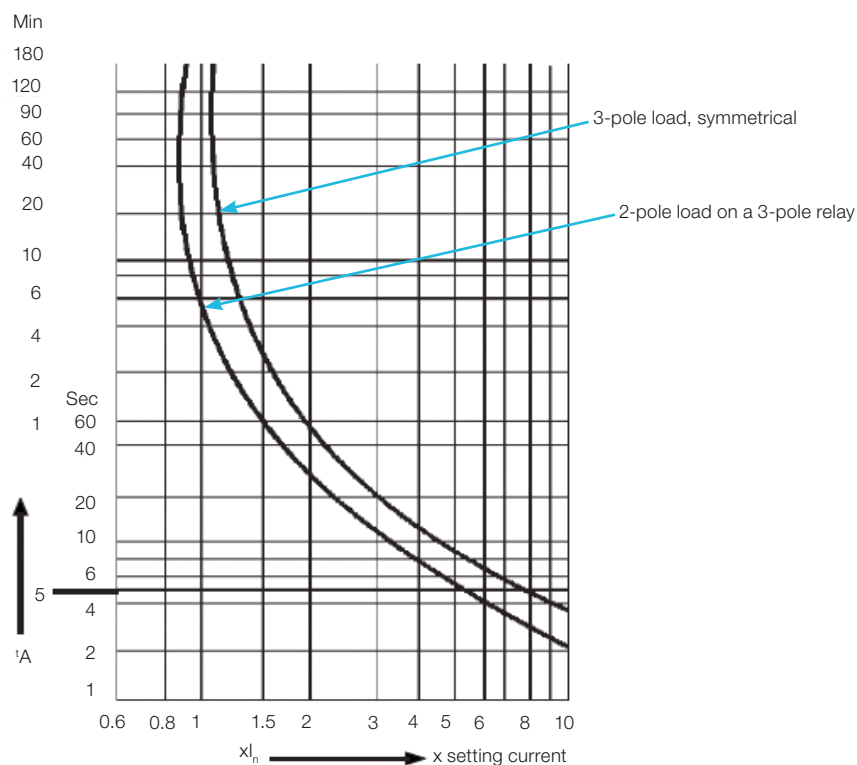

### Multifunction Reset / Test Button

The thermal overload relay has a multifunction **RESET / TEST** button that can be set in four different positions:

- A** - Automatic **RESET** only;
- AUTO** - Automatic **RESET / TEST**;
- HAND** - Manual **RESET / TEST**;
- H** - Manual **RESET** only.

In **HAND** and **AUTO** positions, when **RESET** button is pressed, both NO (97-98) and NC (95-96) contacts change states.



Operation description:

In H (manual RESET only) or A (automatic RESET only) position, the test function is blocked. However in the positions HAND (manual RESET / TEST) or AUTO (automatic RESET / TEST) it is possible to simulate the test and the trip functions by pressing the RESET button.

When set in the H or HAND position the RESET button must be pressed manually to reset the overload relay after a tripping event. On the other hand, when set in A or AUTO position, the overload relay will reset automatically after a tripping event.

The H, HAND, AUTO and A function setting is carried out by rotating without pressing the red button and placing it on the desired position of the RESET button.

When changing from HAND to AUTO, the RESET button must be slightly pressed while the red button is rotated.

Functions	H	HAND	AUTO	A
Relay reset	Manual <sup>1)</sup>	Manual <sup>1)</sup>	Automatic	Automatic
Auxiliary contact trip test 95-96 (NC)	Function is disabled	Test is allowed	Test is allowed	Function is disabled
Auxiliary contact trip test 97-98 (NO)	Function is disabled	Test is allowed	Test is allowed	Function is disabled

Note: 1) A recovery time of a few minutes is necessary before resetting the thermal overload relay.

### Recovery Time

The RW thermal overload relays have thermal memory.

After tripping due to an overload, the relay requires a certain period of time for the bimetal strips to cool down. This period of time is so-called recovery time. The relay can only be reset once it has cooled down. The recovery time depends on the characteristic tripping curves and the level of the tripping current. After tripping due to overload, the recovery time allows the load to cool down.

### Operation in the Output Side of Frequency Inverters

The RW27-2D thermal overload relays are designed for operation on 50/60 Hz up to 400 Hz and the tripping values are related to the heating by currents within this frequency range. Depending on the design of the frequency inverter, the switching frequency can reach several kHz and generate harmonic currents at the output that result in additional temperature rise in the bimetal

strips. In such applications, the temperature rise not only depends on the rms value of the current, but on the induction effects of the higher frequency currents in the metal parts of the device (skin effect caused by eddy currents).

Due to these effects, the current settings on the overload relay should be higher than the motor rated current.

### Certifications



## Thermal Overload Relays RW17...RW407 - Overview

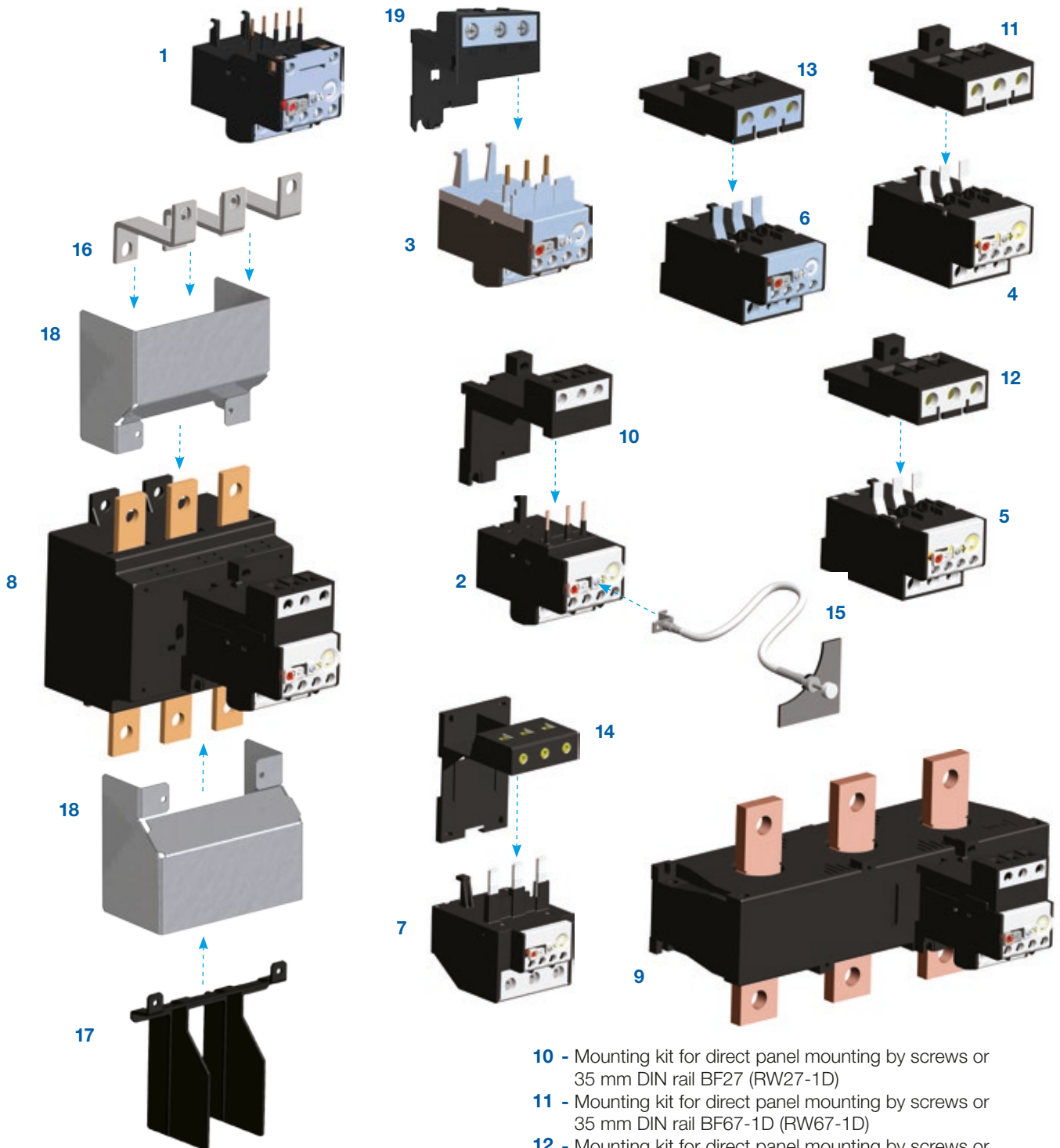

- 1** - RW17-1D (direct mounting on CW07/CWC07...16 compact contactors) and RW17-2D (direct mounting on CWC025 compact contactor)
- 2** - RW27-1D (direct mounting on CWM9...40 contactors)
- 3** - RW27-2D (direct mounting on CWB9...38 contactors)
- 4** - RW67-1D (direct mounting on WM32...40 contactors)
- 5** - RW67-2D (direct mounting on WM50...80 contactors)
- 6** - RW67-5D (direct mounting on CWB40...80 contactors)
- 7** - RW117 (direct mounting on CWM95/105 contactors)
- 8** - RW317 (CWM112...300/CWM400 contactors)
- 9** - RW407 (CWM500...800 contactors)

- 10** - Mounting kit for direct panel mounting by screws or 35 mm DIN rail BF27 (RW27-1D)
- 11** - Mounting kit for direct panel mounting by screws or 35 mm DIN rail BF67-1D (RW67-1D)
- 12** - Mounting kit for direct panel mounting by screws or 35 mm DIN rail BF67-2D (RW67-2D)
- 13** - Mounting kit for direct panel mounting by screws or 35 mm DIN rail BF67-5D (RW67-5D)
- 14** - Mounting kit for direct panel mounting by screws or 35 mm DIN rail BF117D (RW117)
- 15** - ERC\_RW cable for external reset (RW17...407)
- 16** - GA Connector Links for direct mounting of overload relay on contactor
- 17** - IBRW317 phase barrier (RW317)
- 18** - Protection covers for the BMP terminals (RW317)
- 19** - BF27-2D mounting kit for direct panel mounting by screws or 35 mm DIN rail (RW27-2D)

# Thermal Overload Relays - From 0.28 A to 840 A

- Thermal overload relays
- Phase-failure sensitivity according to IEC/EN 60947-4-1
- Tripping class 10
- Auxiliary contacts 1NO + 1NC
- Temperature compensation
- Hand/Auto/Reset button



For direct mounting on contactor	Setting range of overload release (A)	Circuit diagram	Fuse (gL-gG) <sup>1)</sup> A	Reference code	Weight kg	
CW07, CWC07...16	0.28...0.4		2	RW17-1D3-D004	0.155	
CW07, CWC07...16	0.4...0.63		2	RW17-1D3-C063		
CW07, CWC07...16	0.56...0.8		2	RW17-1D3-D008		
CW07, CWC07...16	0.8...1.2		4	RW17-1D3-D012		
CW07, CWC07...16	1.2...1.8		6	RW17-1D3-D018		
CW07, CWC07...16	1.8...2.8		6	RW17-1D3-D028		
CW07, CWC07...16	2.8...4		10	RW17-1D3-U004		
CW07, CWC07...16	4...6.3		16	RW17-1D3-D063		
CW07, CWC07...16	5.6...8		20	RW17-1D3-U008		
CW07, CWC07...16	7...10		25	RW17-1D3-U010		
CW07, CWC07...16	8...12.5		25	RW17-1D3-D125		
CW07, CWC07...16	10...15		35	RW17-1D3-U015		
CW07, CWC07...16	11...17		40	RW17-1D3-U017		
CWC025	7...10		25	RW17-2D3-U010	0.155	
CWC025	8...12.5		25	RW17-2D3-D125		
CWC025	10...15		35	RW17-2D3-U015		
CWC025	11...17		40	RW17-2D3-U017		
CWC025	15...23		50	RW17-2D3-U023		
CWC025	22...32		63	RW17-2D3-U032		
CWB9...38	0.28...0.4			2	RW27-2D3-D004	0.165
CWB9...38	0.43...0.63			2	RW27-2D3-C063	
CWB9...38	0.56...0.8			2	RW27-2D3-D008	
CWB9...38	0.8...1.2			4	RW27-2D3-D012	
CWB9...38	1.2...1.8			6	RW27-2D3-D018	
CWB9...38	1.8...2.8			6	RW27-2D3-D028	
CWB9...38	2.8...4			10	RW27-2D3-U004	
CWB9...38	4...6.3			16	RW27-2D3-D063	
CWB9...38	5.6...8			20	RW27-2D3-U008	
CWB9...38	7...10			25	RW27-2D3-U010	
CWB9...38	8...12.5			25	RW27-2D3-D125	
CWB9...38	10...15			35	RW27-2D3-U015	
CWB9...38	11...17			40	RW27-2D3-U017	
CWB9...38	15...23	50		RW27-2D3-U023		
CWB9...38	22...32	63		RW27-2D3-U032		
CWB9...38	32...40	90		RW27-2D3-U040		
CWB40...80	25...40	80		RW67-5D3-U040	0.320	
CWB40...80	32...50	80		RW67-5D3-U050		
CWB40...80	40...57	100		RW67-5D3-U057		
CWB40...80	50...63	100		RW67-5D3-U063		
CWB40...80	57...70	125	RW67-5D3-U070			
CWB40...80	63...80	125	RW67-5D3-U080			

Note: 1) Maximum fuse.



## Thermal Overload Relays - From 0.28 A to 840 A

- Thermal overload relays
- Phase-failure sensitivity according to IEC/EN 60947-4-1
- Tripping class 10
- Auxiliary contacts 1NO + 1NC
- Temperature compensation
- Hand/Auto/Reset button

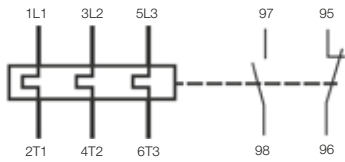

For direct mounting on contactor	Setting range of overload release (A)	Circuit diagram	Fuse (gL-gG) <sup>1)</sup> A	Reference code	Weight kg
CWM9...40	0.28...0.4		2	RW27-1D3-D004	0.165
CWM9...40	0.43...0.63		2	RW27-1D3-C063	
CWM9...40	0.56...0.8		2	RW27-1D3-D008	
CWM9...40	0.8...1.2		4	RW27-1D3-D012	
CWM9...40	1.2...1.8		6	RW27-1D3-D018	
CWM9...40	1.8...2.8		6	RW27-1D3-D028	
CWM9...40	2.8...4		10	RW27-1D3-U004	
CWM9...40	4...6.3		16	RW27-1D3-D063	
CWM9...40	5.6...8		20	RW27-1D3-U008	
CWM9...40	7...10		25	RW27-1D3-U010	
CWM9...40	8...12.5		25	RW27-1D3-D125	
CWM9...40	10...15		35	RW27-1D3-U015	
CWM9...40	11...17		40	RW27-1D3-U017	
CWM9...40	15...23		50	RW27-1D3-U023	
CWM9...40	22...32		63	RW27-1D3-U032	
CWM32...40	25...40		90	RW67-1D3-U040	0.320
CWM32...40	32...50		125	RW67-1D3-U050	
CWM50...80	25...40		90	RW67-2D3-U040	0.320
CWM50...80	32...50		125	RW67-2D3-U050	
CWM50...80	40...57		150	RW67-2D3-U057	
CWM50...80	50...63	150	RW67-2D3-U063		
CWM50...80	57...70	175	RW67-2D3-U070		
CWM50...80	63...80	200	RW67-2D3-U080		
CWM95...105	63...80	200	RW117-1D3-U080	0.490	
CWM95...105	75...97	225	RW117-1D3-U097		
CWM95...105	90...112	250	RW117-1D3-U112		

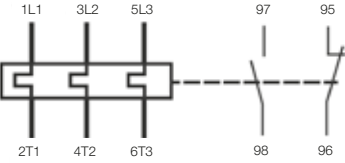

For use with contactor	Setting range of overload release (A)	Circuit diagram	Fuse (gL-gG) <sup>1)</sup> A	Reference code	Weight kg
CWM112 <sup>2)</sup>	63...80		200	RW117-2D3-U080	0.750
	75...97		225	RW117-2D3-U097	
	90...112		250	RW117-2D3-U112	
CWM112...300 <sup>3)</sup> , CWM400 <sup>3)</sup>	100...150		315	RW317-1D3-U150	1.985
	140...215		355	RW317-1D3-U215	
	200...310		500	RW317-1D3-U310	
	275...420		710	RW317-1D3-U420	
CWM500...800	400...600		1,000	RW407-1D3-U600 <sup>3)</sup>	3.435
	560...840		1,250	RW407-1D3-U840 <sup>3)</sup>	

Notes: 1) Maximum fuse;

2) Allows assembly with contactor using connector links GA;

3) It is possible to connect contactors to RW407 overload relay by using GA407-1D connector links or routing contactor-to-motor cables through the Ø32 mm window available in the overload relay.

## Accessories

### Base for Separate Mounting

Illustrative picture	Description	For use with	Reference code	Weight (kg)
	Enables overload to be mounted directly to a panel via screws or DIN rail 35 mm	RW27-1D	BF27D	0.050
		RW27-2D	BF27-2D	
		RW67-1D	BF67-1D	0.095
		RW67-2D	BF67-2D	
		RW67-5D	BF67-5D	
		RW117-1D	BF117D	0.110

### Connector Links for Connection

Illustrative picture	Overload relay	Contactors	Reference code	Weight (kg)
	RW117-2D	CWM112	GA117D	0.135
	RW317	CWM112/150	GA317-1D	0.250
	RW317	CWM180	GA317-2D	0.270
	RW317	CWM250/300	GA317-3D	0.630
	RW317	CWM400	GA317-10D	0.500
	RW67-1D or RW67-2D	CWB40...80	GA67-B80	0.030
	RW67-1D	CWM32/40	GA67-1D	0.030
	RW67-2D	CWM50...80	GA67-2D	0.030

### External Reset

Illustrative picture	Description	Flexible cable size	Reference code	Weight (kg)
	Metallic cable for external reset suitable to all models of RW overload relays. Remarks: - Required hole on panel door: Ø6.5...7 mm - Required thickness of panel door: 2 mm...4.25 mm	250 mm	ERC250RW	0.034
		375 mm	ERC375RW	0.036
		500 mm	ERC500RW	0.041

### Insulator Barrier

Illustrative picture	Description	For use with	Reference code	Weight (kg)
	One plastic phase barrier + screws, to be used on the overload relay line or load side. The distance between busbars of RW317 overload relays are the minimum required in order to comply with U <sub>n</sub> =1,000 V, pollution degree 3. When the distance between cables or busbars connected to the overload relay are smaller than that, phase barriers IBRW317 should be used.	RW317	IBRW317	0.044

### Reset Pushbutton with Shaft

Illustrative picture	Description	For use with O/L relays	Reference code	Weight kg
	Flush RESET pushbutton with shaft / Blue color Shaft size: Min: 22.5 mm / Max: 250 mm	RW	CSW-BHF437	0.032
	Extended RESET pushbutton with shaft / Blue color Shaft size: Min: 22.5 mm / Max: 250 mm		CSW-BHS437	0.032

### Cover Protection

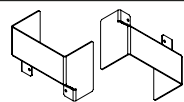
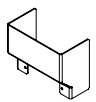
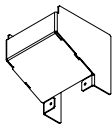
Illustrative picture	Description	Number of parts	Use with	Reference code	Weight (kg)
	Terminal cover against accidental touches on upper and lower power terminals. Material in polycarbonate not inflammable. This accessory assure frontal degree of protection IP20 in overload relay.	2	RW317	BMPRW317	0.18
		1	RW317	BMP1RW317	0.09
	Terminal cover against accidental touch on upper power terminals of overload relay when used with connector link GA317-10D. Material in polycarbonate not inflammable. This accessory assure frontal degree of protection IP20 in overload relay.	1	CWM400 + GA317-10D + RW317	BMP1RW317-CWM400	0.18

# Technical Data

## General Data and Main Contacts

Reference code	RW17	RW27	RW67	RW117	RW317	RW407
Standards	IEC/EN 60947 / UL 508 / UL 60947					
Setting current (A)	0.28...17	0.28...32	25...80	75...112	100...420	400...840
Tripping class	10					
Temperature compensation	Continuous					
Rated insulation voltage $U_i$ (pollution degree 3) IEC/EN 60947 (V)	690			1,000		
UL/CSA (V)	600			600		
Rated impulse withstand voltage $U_{imp}$ (kV)	6			8		
Rated operational frequency (Hz)	0..400					
Degree of protection Protection against direct contact from the front when actuated by a perpendicular test finger (IEC/EN 60536)	IP20 Finger and back-of-hand proof					
Ambient temperature Operating temperature Storage temperature	-25 °C to +60 °C -40 °C to +70 °C					
Climating proof IEC/EN 60 068-2-3 IEC/EN 60 068-2-30	Damp heat, constant Damp heat, constant					
Current heat loss Lower value of setting range (W) Higher value of setting range (W)	0.9 1.4	0.9 1.7	1.5 4.7	2.3 4.7	1 1.9	

## Auxiliary Contacts

Models	RW17	RW27	RW67	RW117	RW317	RW407	
Standards	IEC/EN 60 947-4-1 and UL 508						
Rated insulation voltage $U_i$ (pollution degree 3) IEC/EN (V)	690			690			
UL, CSA (V)	600			600			
Rated operational voltage $U_e$ IEC/EN (V)	690			690			
UL, CSA (V)	600			600			
Rated thermal current $I_{th}$ ( $\theta \leq 55$ °C) (A)	6						
Rated operational current $I_e$							
AC-14 / AC-15 (IEC/EN 60947-5-1)	24 V (A)					4	
	60 V (A)					3.5	
	125 V (A)					3	
	230 V (A)					2	
	400 V (A)					1.5	
	500 V (A)					0.5	
	690 V (A)					0.3	
UL, CSA	C600						
DC-13 / DC-14 (IEC/EN 60947-5-1)	24 V (A)					1	
	60 V (A)					0.5	
	110 V (A)					0.25	
	220 V (A)					0.1	
UL, CSA	R300						
Short-circuit protection with fuse (gL/gG) (A)	6						
Minimum voltage / admissible current (IEC/EN 60947-5-4)	17 V / 5 mA						

## Terminal Capacity and Tightening Torque - Main Contacts

Reference	RW17	RW27	RW67	RW117	RW317	RW407
Current setting (A)	0.28...17	0.28...32	25...80	75...112	100...215	200...420
Cable size (75 °C / Cu cable)						
Flexible cable	1 cable (mm <sup>2</sup> )	1,5...10	6,0...35	25...35	35...120	95...150
	2 cables (mm <sup>2</sup> )		-	-		
Cable with terminal or rigid cable	1 cable (mm <sup>2</sup> )	1,5...6,0	6,0...35	25...35	35...120	95...150
	2 cables (mm <sup>2</sup> )		-	-		
Busbar (mm <sup>2</sup> )	-			Max 2x (25x5)		Max 2x (60x10)
Tightening torque (N.m)	2,3		4,0	6,0	16,0	26,0
UL cable size (75 °C - Cu cable) AWG	16...8		10...3	6...1/0	3-300 kcmil	3/0 - 600 kcmil
Tightening torque (UL) (lb.in)	20		35	53	141	230

## Terminal Capacity and Tightening Torque - Auxiliary Contacts

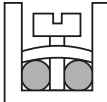
Models	RW17	RW27	RW67	RW117	RW317	RW407
Type of screws	M3.5 x 10 Phillips					
Cable size (75 °C / Cu cable)						
Cable with or without terminal (mm <sup>2</sup> )			2 x 1...2.5			
AWG-wire			16...12			
Tightening torque (N.m / lb.in)			1.5 / 13			

# Diagrams

## Motor Protection - Direct Current

### 1-Pole

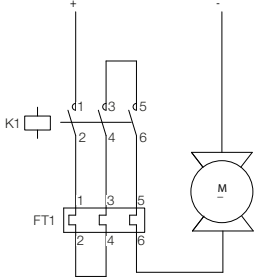

### 2-Pole

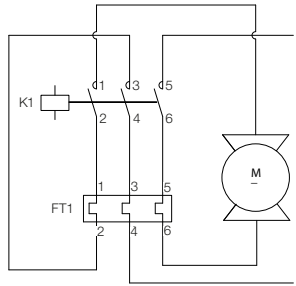

## Motor Protection - Alternating Current

### 3-Pole

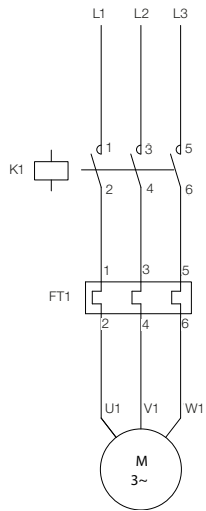

### 2-Pole

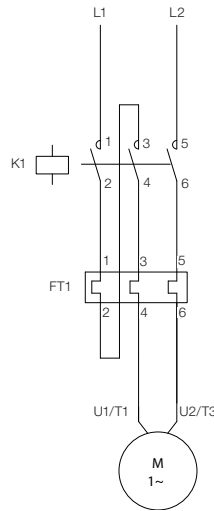

## Connection Suggestion - Contactor + Overload Relay

### Direct On Line Starter (1 Direction of Rotation)

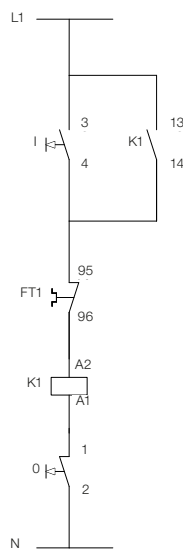

### Direct On Line Starter (2 Directions of Rotation)

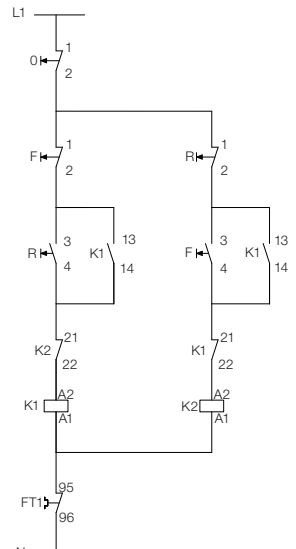



## Dimensions (mm)

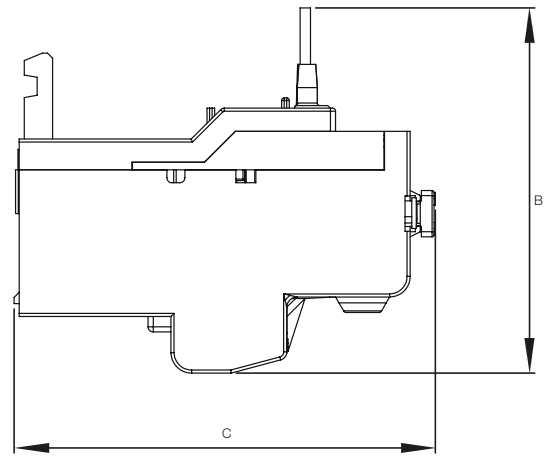
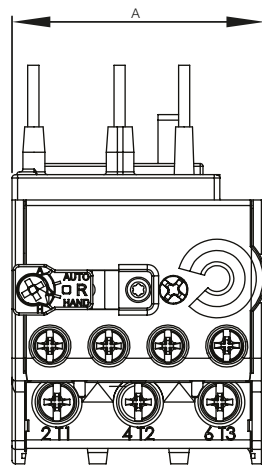

	RW17-1D RW17-2D RW27-1D RW27-2D	RW67-1D	RW67-2D	RW67-5D	RW117-1D
<b>A</b>	45.0	50.0	50.0	50.0	75.0
<b>B</b>	71.5	76.5	81.5	71.5	99.5
<b>C</b>	83.5	106.5	106.5	106.5	98.8

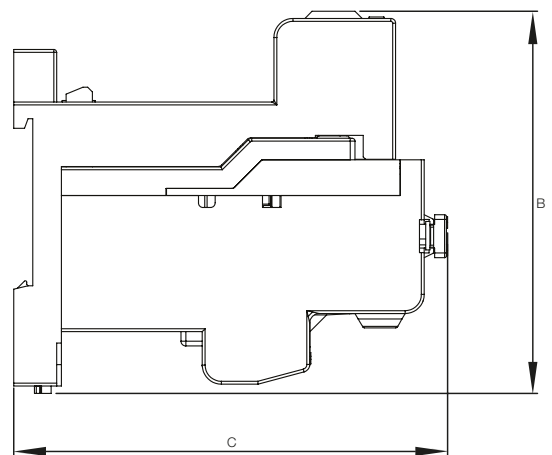
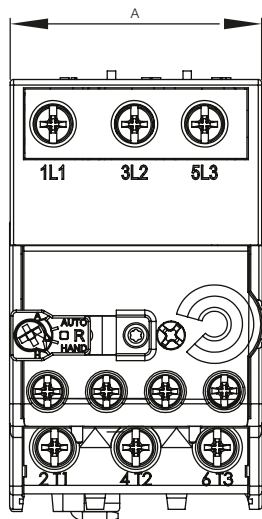

	BF27D + RW27-1D BF27-2D + RW27-2D	BF67-1D + RW67-1D BF67-2D + RW67-2D BF67-5D + RW67-5D	BF117D + RW117-1D RW117-2D
<b>A</b>	45.0	50.0	75.0
<b>B</b>	80.0	71.0	116.4
<b>C</b>	92.5	106.0	106.2

## Dimensions (mm)

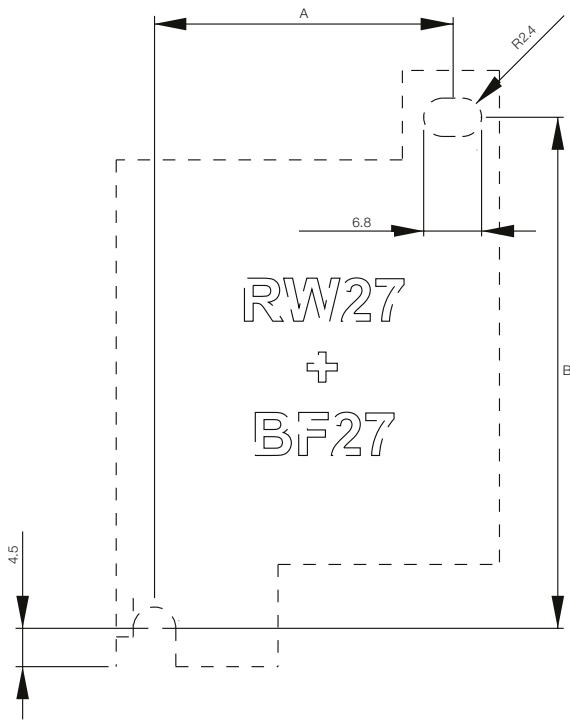

	BF27D	BF27-2D
A	34	34
B	60	65

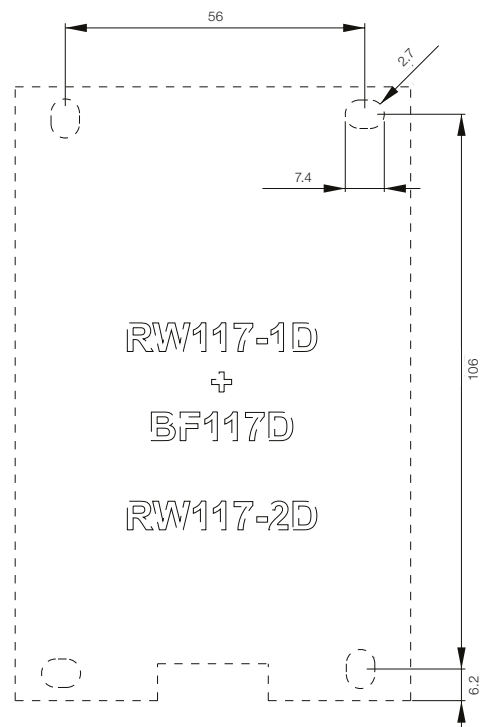
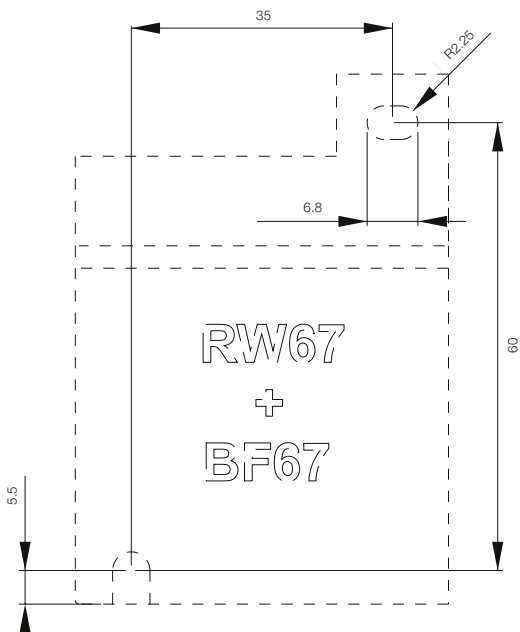

## Dimensions (mm)

### RW317

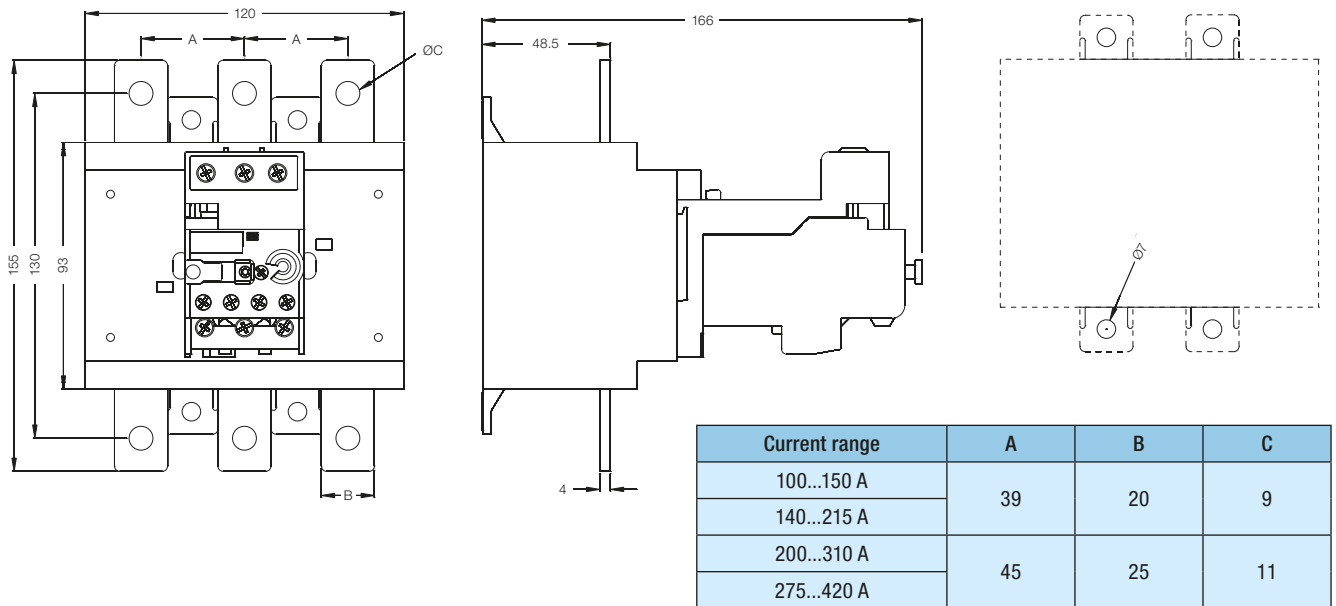

### RW407

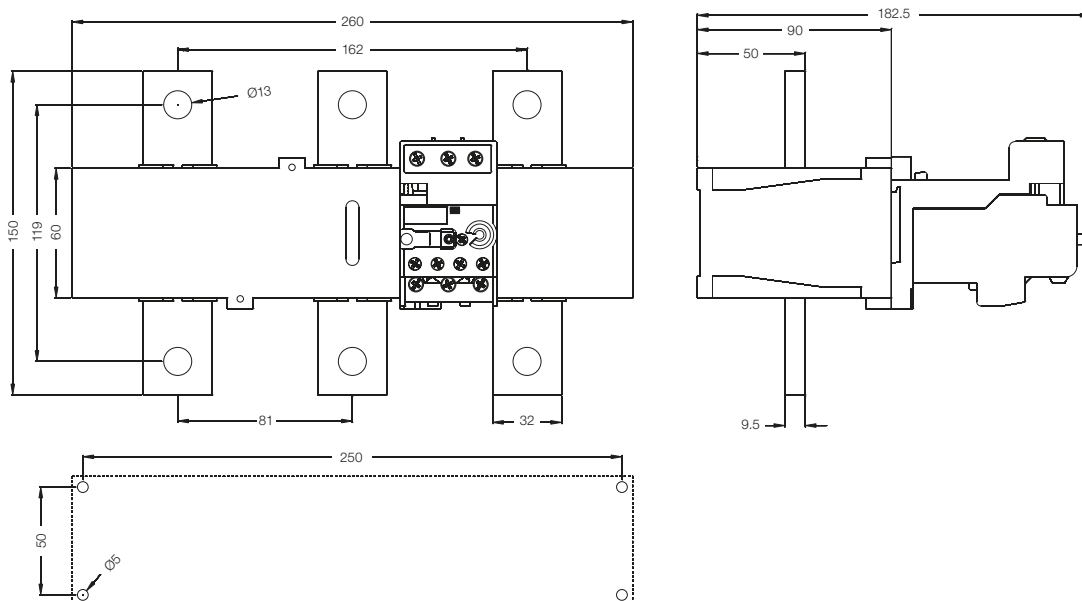

## Installation

### RW17...407

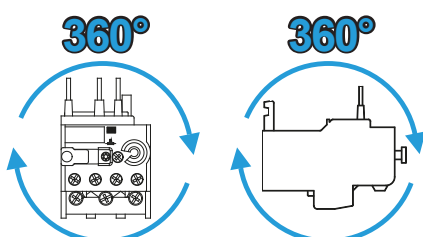

## Dimensions (mm)

### ERCRW

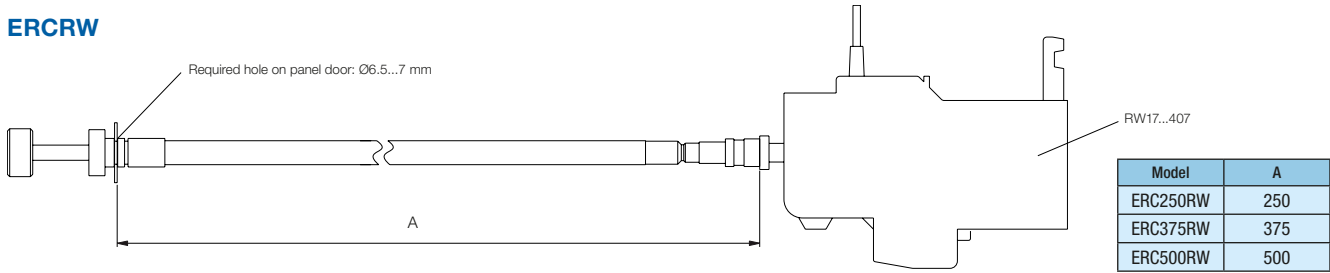

### IBRW317

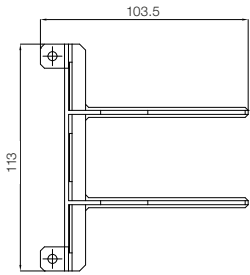

### RW317+IBRW317

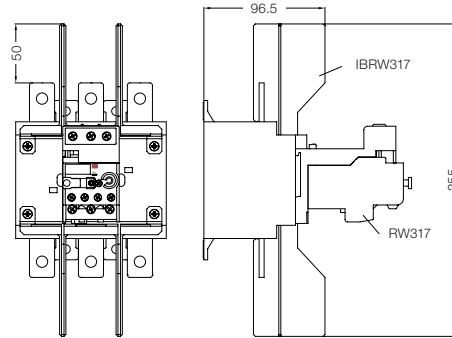

### BMPRW317

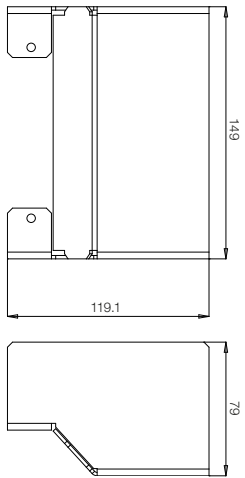

### RW317+ BMPRW317

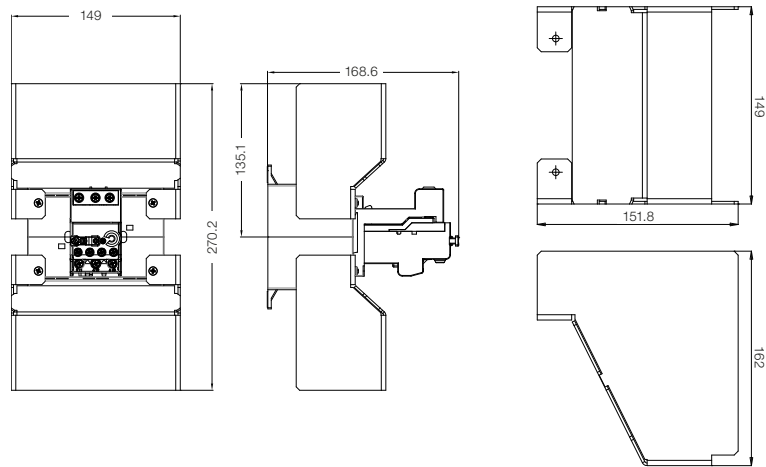

### BMP1RW317-CWM400

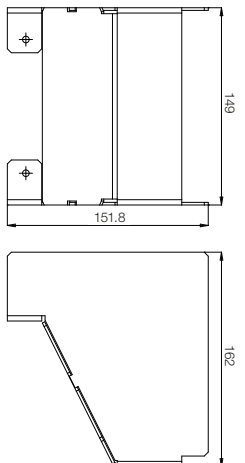



## Dimensions (mm)

### CW07 + RW17-1D

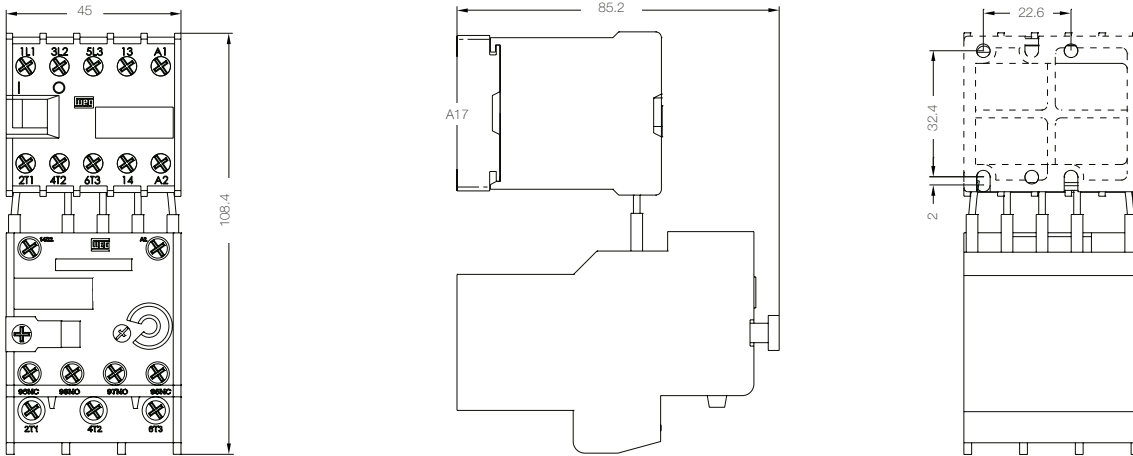

### CWC07...16 + RW17-1D

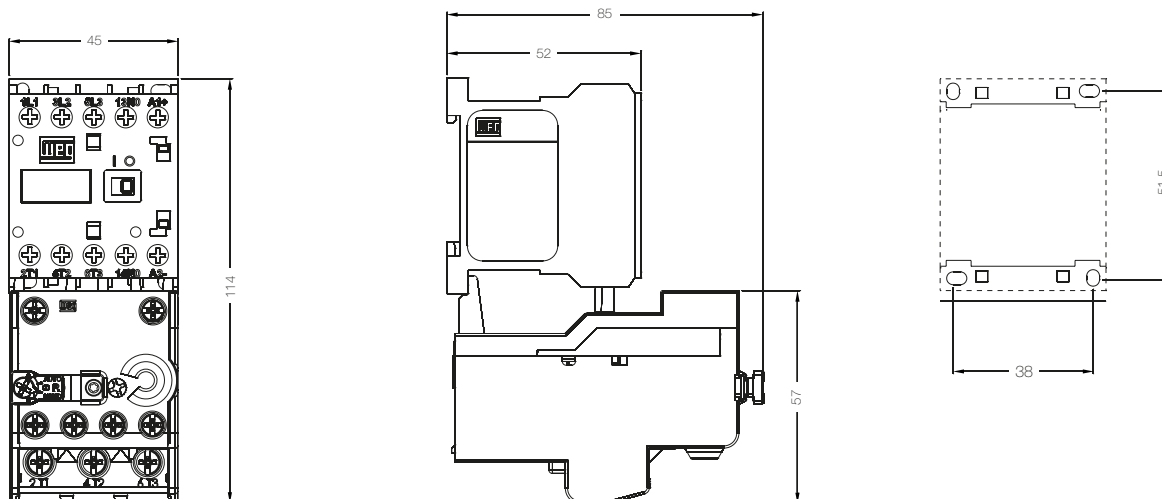

### CWC025 + RW17-2D

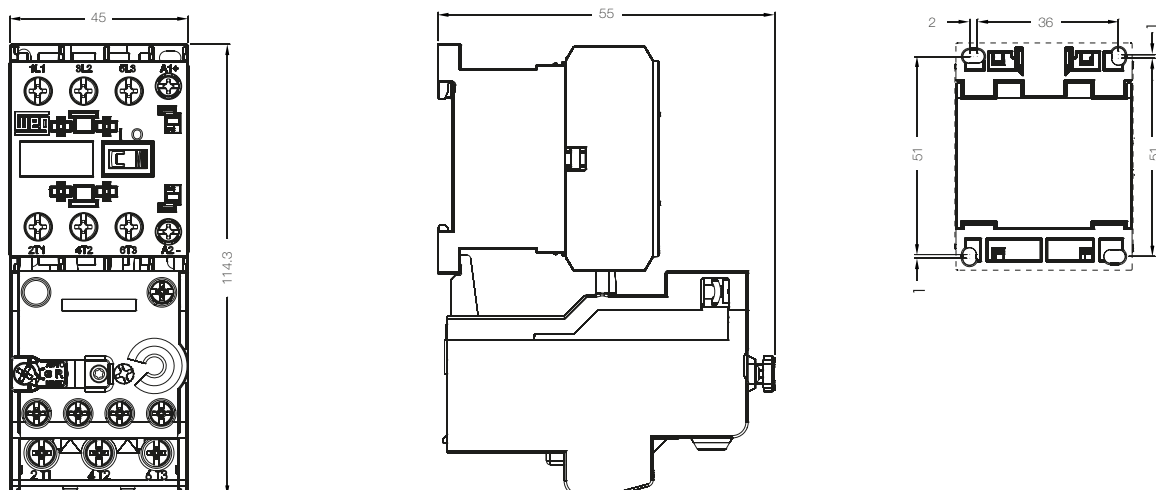

## Dimensions (mm)

### CWB9...38 + RW27-2D

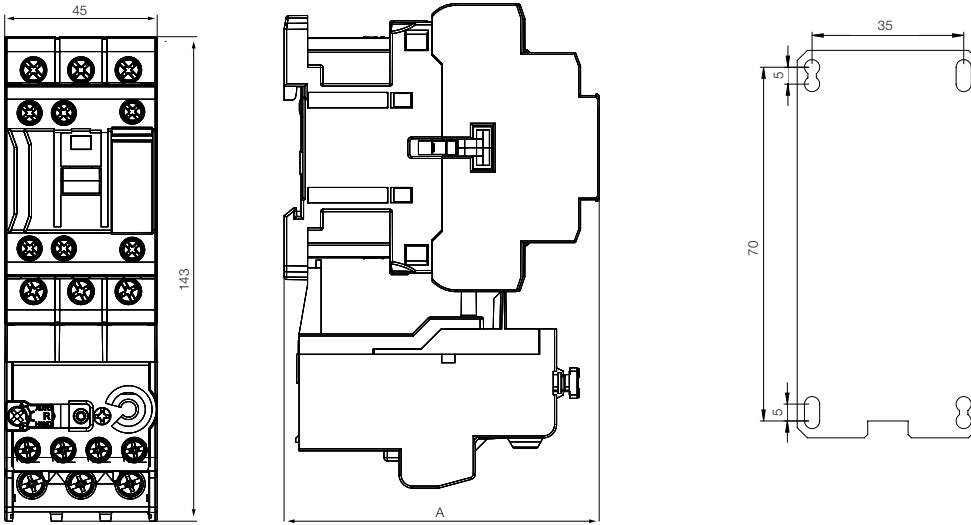

CWB9...38	A
AC coil	93
DC coil	102.2

### CWB40...80 + RW67-5D

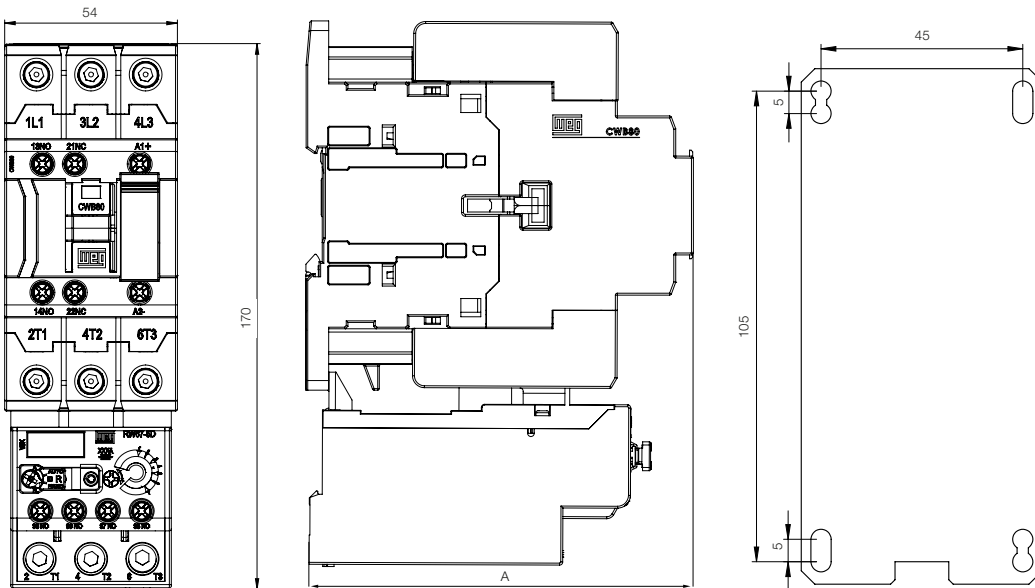

CWB40...80	A
AC coil	120.6
DC coil	120.6

### CWM9...25 + RW27-1D

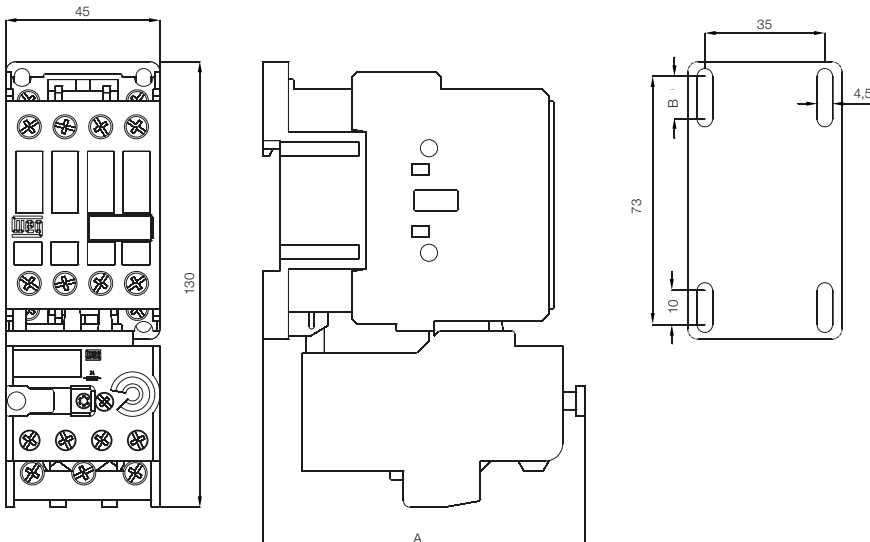

CWM9...25	A	B
AC coil	94	4.8
DC coil	124	13

## Dimensions (mm)

### CWM32 + RW27-1D

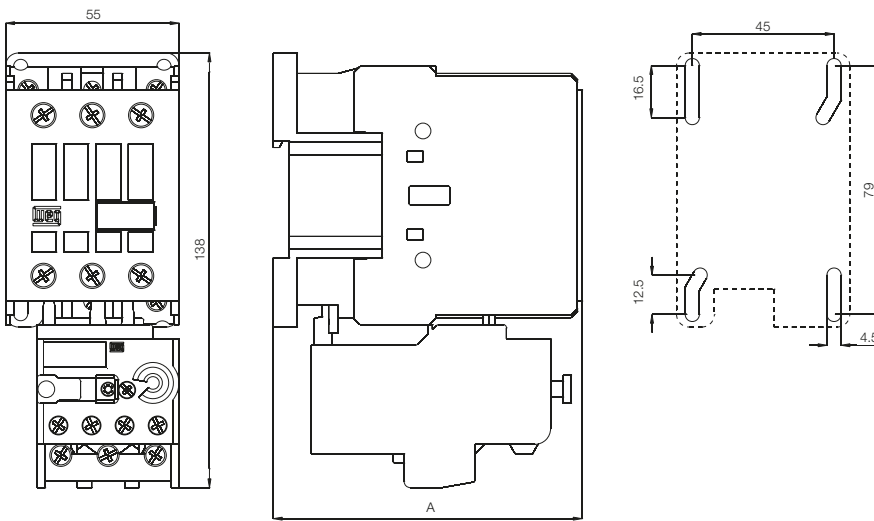

CWM32	A
AC coil	98
DC coil	118

### CWM32/40 + RW67-1D

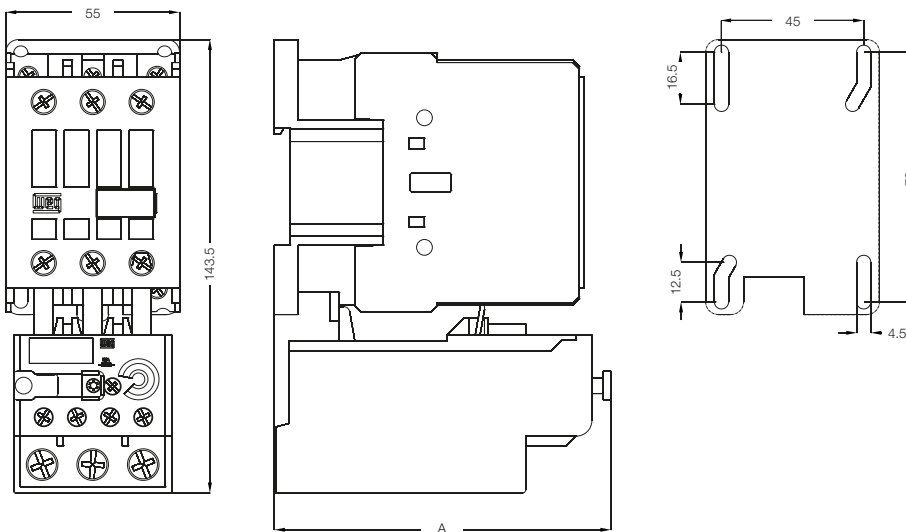

CWM32/40	A
AC coil	106.5
DC coil	126.5

### CWM50...80 + RW67-2D

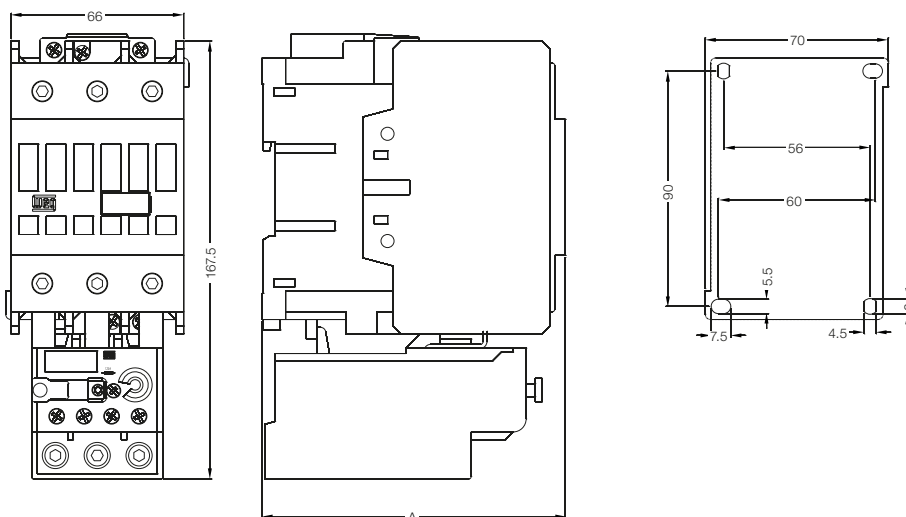

CWM50...80	A
AC coil	116
DC coil	116

## Dimensions (mm)

### CWM95/105 + RW117-1D

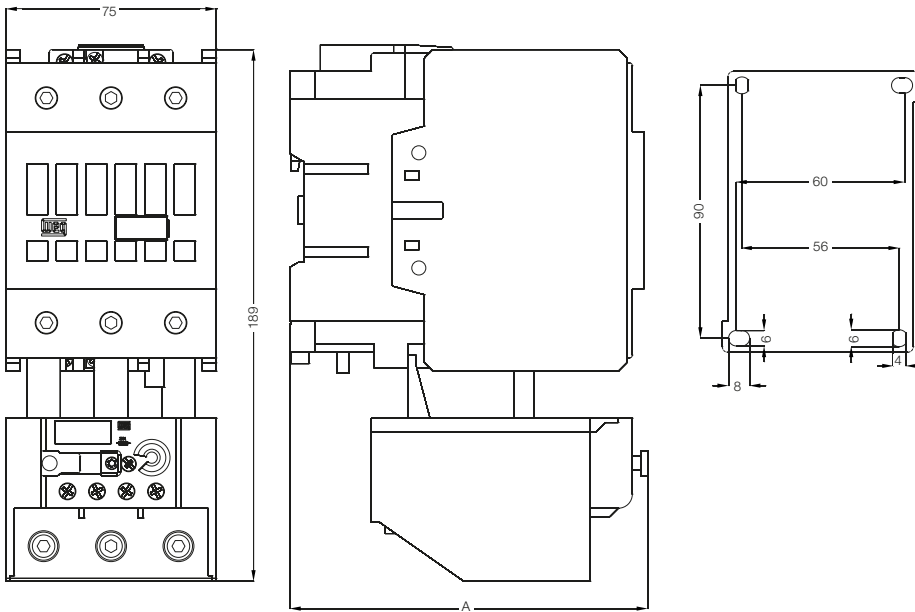

CWM95/105	A
AC coil	127.5
DC coil	127.5

### CWM112 + RW117-2D

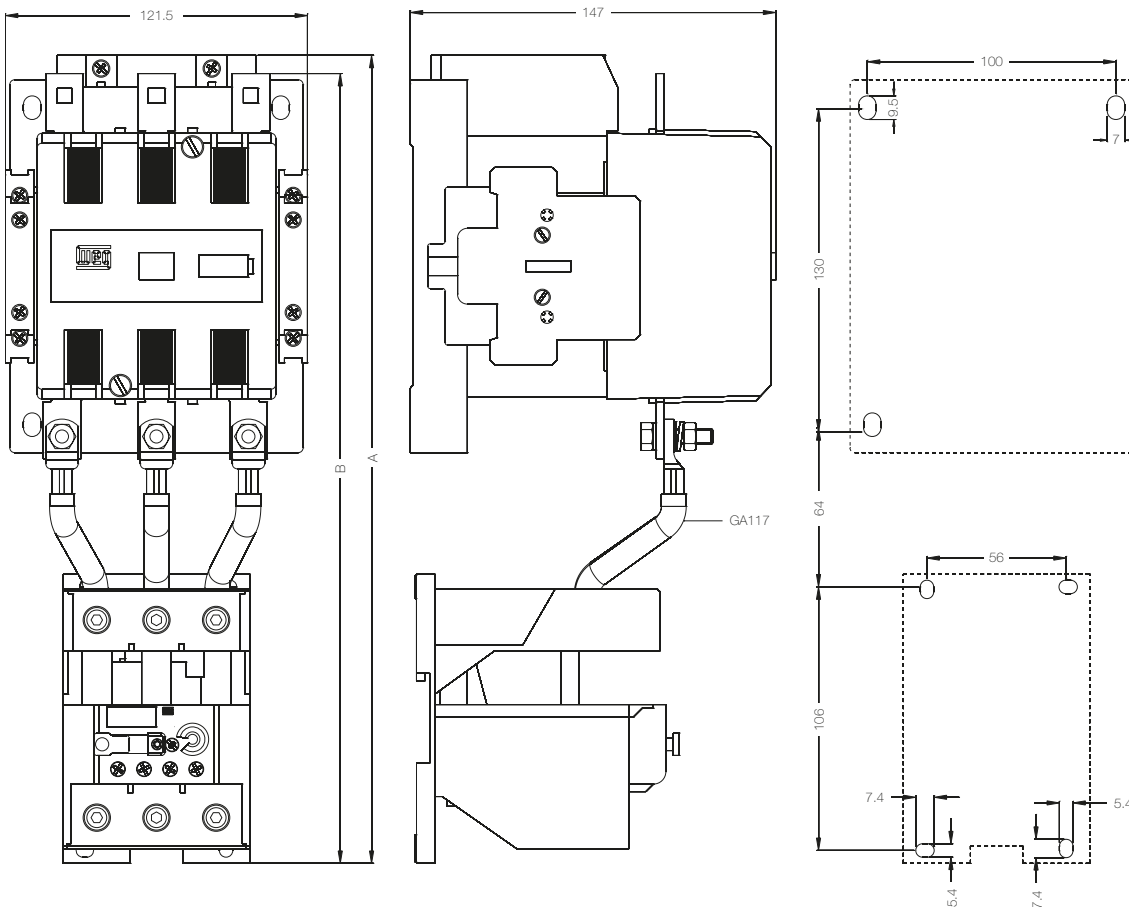

CWM112	A	B
Standard coil	-	317.7
Electronic module	325	317.7



## Dimensions (mm)

### CWM112/150 + RW317

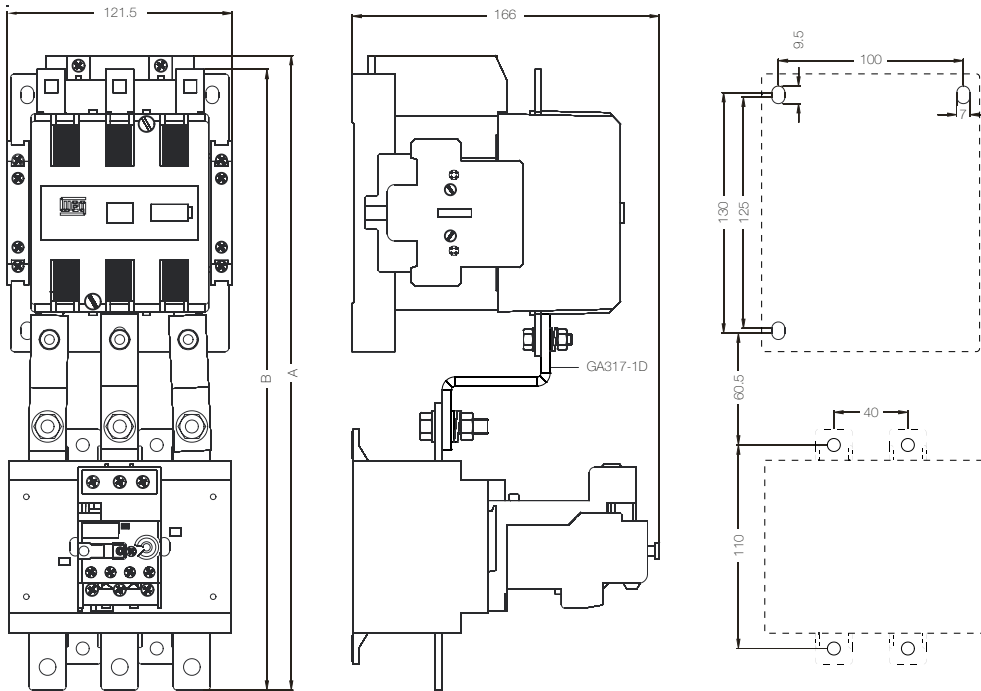

	A	B
CWM112 (standard coil)	-	335.5
CWM112/150 (electronic module)	343	335.5

### CWM180 + RW317

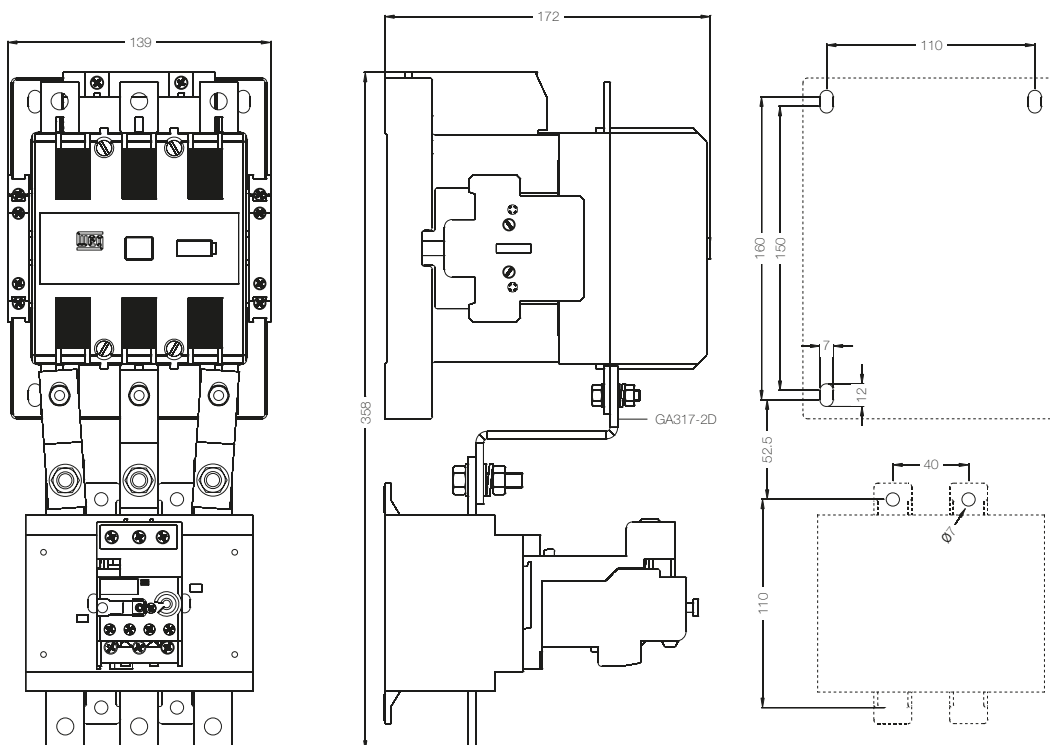

## Dimensions (mm)

### CWM250/300 + RW317

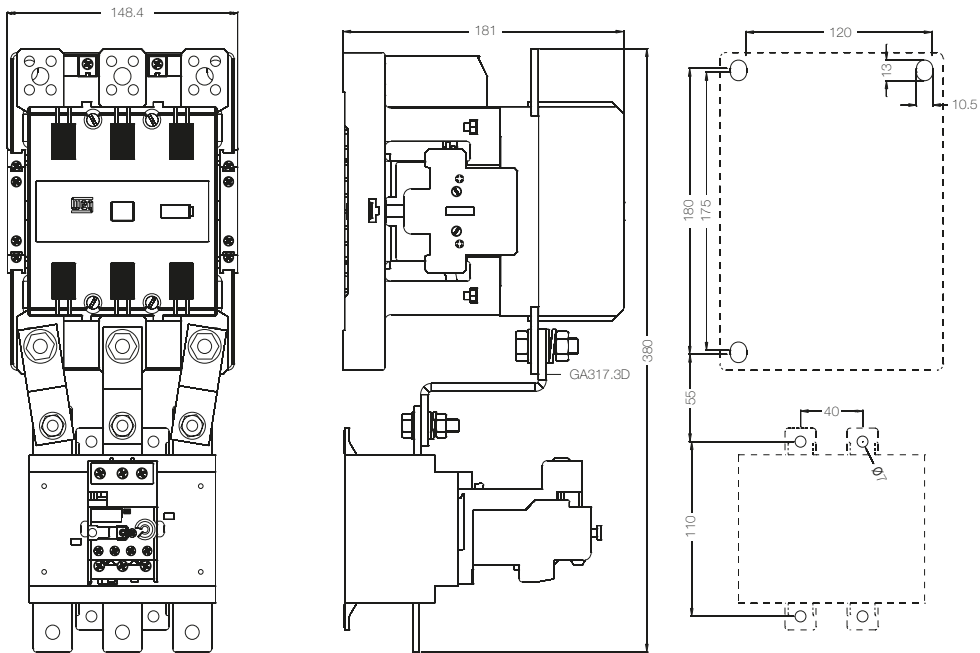

### CWM400 + RW317

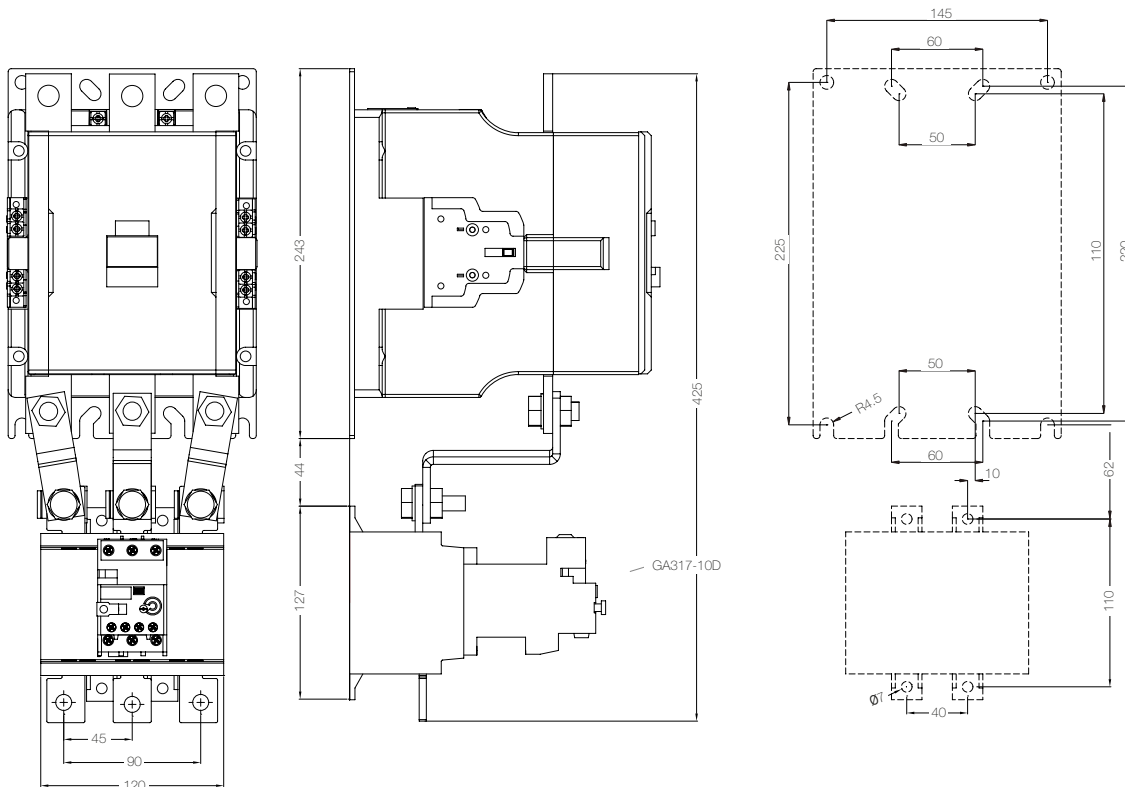

**Global presence** is essential,  
as much as understanding your needs.

#### Global Presence

With more than 30.000 employees worldwide, WEG is one of the largest electric motors, electronic equipments and systems manufacturers. We are constantly expanding our portfolio of products and services with expertise and market knowledge. We create integrated and customized solutions ranging from innovative products to complete after-sales service.

WEG's know-how guarantees our **Thermal Overload Relays RW Line** are the right choice for your application and business, assuring safety, efficiency and reliability.



**Availability** is to have a global support network



**Partnership** is to create solutions that suits your needs



**Competitive edge** is to unite technology and innovation

## Know More

High performance and reliable products to improve your production process.

Excellence is to provide a whole solution in industrial automation that improves our customers productivity.



Visit: [www.weg.net](http://www.weg.net)

 [youtube.com/wegvideos](https://youtube.com/wegvideos)

# WEG Worldwide Operations

## ARGENTINA

San Francisco - Cordoba  
Phone: +54 3564 421484  
[info-ar@weg.net](mailto:info-ar@weg.net)

Cordoba - Cordoba  
Phone: +54 351 4641366  
[weg-morbe@weg.com.ar](mailto:weg-morbe@weg.com.ar)

Buenos Aires  
Phone: +54 11 42998000  
[ventas@pulverlux.com.ar](mailto:ventas@pulverlux.com.ar)

## AUSTRALIA

Scoresby - Victoria  
Phone: +61 3 97654600  
[info-au@weg.net](mailto:info-au@weg.net)

## AUSTRIA

Markt Piesting - Wiener  
Neustadt-Land  
Phone: +43 2633 4040  
[watt@wattdrive.com](mailto:watt@wattdrive.com)

## BELGIUM

Nivelles - Belgium  
Phone: +32 67 888420  
[info-be@weg.net](mailto:info-be@weg.net)

## BRAZIL

Jaraguá do Sul - Santa Catarina  
Phone: +55 47 32764000  
[info-br@weg.net](mailto:info-br@weg.net)

## CHILE

La Reina - Santiago  
Phone: +56 2 27848900  
[info-cl@weg.net](mailto:info-cl@weg.net)

## CHINA

Nantong - Jiangsu  
Phone: +86 513 85989333  
[info-cn@weg.net](mailto:info-cn@weg.net)

Changzhou - Jiangsu  
Phone: +86 519 88067692  
[info-cn@weg.net](mailto:info-cn@weg.net)

## COLOMBIA

San Cayetano - Bogota  
Phone: +57 1 4160166  
[info-co@weg.net](mailto:info-co@weg.net)

## ECUADOR

El Batan - Quito  
Phone: +593 2 5144339  
[ceccato@weg.net](mailto:ceccato@weg.net)

## FRANCE

Saint-Quentin-Fallavier - Isère  
Phone: +33 4 74991135  
[info-fr@weg.net](mailto:info-fr@weg.net)

## GERMANY

Türnich - Kerpen  
Phone: +49 2237 92910  
[info-de@weg.net](mailto:info-de@weg.net)

Balingen - Baden-Württemberg  
Phone: +49 7433 90410  
[info@weg-antriebe.de](mailto:info@weg-antriebe.de)

Homberg (Efze) - Hesse  
Phone: +49 5681 99520  
[info@akh-antriebstechnik.de](mailto:info@akh-antriebstechnik.de)

## GHANA

Accra  
Phone: +233 30 2766490  
[info@zestghana.com.gh](mailto:info@zestghana.com.gh)

## INDIA

Bangalore - Karnataka  
Phone: +91 80 41282007  
[info-in@weg.net](mailto:info-in@weg.net)

Hosur - Tamil Nadu  
Phone: +91 4344 301577  
[info-in@weg.net](mailto:info-in@weg.net)

## ITALY

Cinisello Balsamo - Milano  
Phone: +39 2 61293535  
[info-it@weg.net](mailto:info-it@weg.net)

## JAPAN

Yokohama - Kanagawa  
Phone: +81 45 5503030  
[info-jp@weg.net](mailto:info-jp@weg.net)

## MALAYSIA

Shah Alam - Selangor  
Phone: +60 3 78591626  
[info@wattdrive.com.my](mailto:info@wattdrive.com.my)

## MEXICO

Huehuetoca - Mexico  
Phone: +52 55 53214275  
[info-mx@weg.net](mailto:info-mx@weg.net)

Tizayuca - Hidalgo  
Phone: +52 77 97963790

## NETHERLANDS

Oldenzaal - Overijssel  
Phone: +31 541 571080  
[info-nl@weg.net](mailto:info-nl@weg.net)

## PERU

La Victoria - Lima  
Phone: +51 1 2097600  
[info-pe@weg.net](mailto:info-pe@weg.net)

## PORTUGAL

Maia - Porto  
Phone: +351 22 9477700  
[info-pt@weg.net](mailto:info-pt@weg.net)

## RUSSIA and CIS

Saint Petersburg  
Phone: +7 812 363 2172  
[sales-wes@weg.net](mailto:sales-wes@weg.net)

## SOUTH AFRICA

Johannesburg  
Phone: +27 11 7236000  
[info@zest.co.za](mailto:info@zest.co.za)

## SPAIN

Coslada - Madrid  
Phone: +34 91 6553008  
[wegiberia@wegiberia.es](mailto:wegiberia@wegiberia.es)

## SINGAPORE

Singapore  
Phone: +65 68589081  
[info-sg@weg.net](mailto:info-sg@weg.net)

Singapore  
Phone: +65 68622220  
[watteuro@watteuro.com.sg](mailto:watteuro@watteuro.com.sg)

## SCANDINAVIA

Mölnlycke - Sweden  
Phone: +46 31 888000  
[info-se@weg.net](mailto:info-se@weg.net)

## UK

Redditch - Worcestershire  
Phone: +44 1527 513800  
[info-uk@weg.net](mailto:info-uk@weg.net)

## UNITED ARAB EMIRATES

Jebel Ali - Dubai  
Phone: +971 4 8130800  
[info-ae@weg.net](mailto:info-ae@weg.net)

## USA

Duluth - Georgia  
Phone: +1 678 2492000  
[info-us@weg.net](mailto:info-us@weg.net)

Minneapolis - Minnesota  
Phone: +1 612 3788000

## VENEZUELA

Valencia - Carabobo  
Phone: +58 241 8210582  
[info-ve@weg.net](mailto:info-ve@weg.net)

For those countries where there is not a WEG own operation, find our local distributor at [www.weg.net](http://www.weg.net).



WEG Group - Automation Business Unit  
Jaraguá do Sul - SC - Brazil  
Phone: +55 47 3276 4000  
[automacao@weg.net](mailto:automacao@weg.net)  
[www.weg.net](http://www.weg.net)

