

# Wire Rope Isolators

Vibration Control

ACE: Your partner for vibration control,  
industrial shock absorbers and gas springs

Special Catalog 2020



Helical Isolator



Square Mount Isolator

# Vibration Control

Wire Rope Isolators

**NEW**

Vibration-Isolating Pads

Rubber-Metal Isolators

Low Frequency Pneumatic Levelling Mounts

---



# Wire Rope Isolators

## Isolation and damping of vibrations

Noise reduction and vibration insulation are becoming increasingly important in our daily lives. Wire rope isolators are ideal for shock and vibration-proof bearings. They also meet the requirements of military assumptions such as MIL specifications.

Due to the great variety in the possible design of wire rope isolators, they can isolate a wide range of different loads from vibration. The WR, WRS and CR families are suitable for masses from a few grams up to several tons and are absolutely maintenance-free.

Wire rope isolators can be used particularly well in areas where other vibration isolators cannot be used due to extreme conditions such as heat or cold, acids, seawater, UV, etc.

Wire rope isolators offer a particularly large usable spring travel, low natural frequencies, low resonance transmission and rapid decay of the amplitude in the event of shocks. Furthermore, there are no signs of fatigue after dynamic overload.

### Wire Rope Isolators



**WR**  
**Helical Isolator**

WR2, WR3, WR4, WR5, WR6A, WR6, WR8, WR10, WR12A, WR12, WR16A, WR16, WR20, WR24, WR28, WR32, WR36, WR40

Page 2 to 73



**WRS**  
**Helical Isolator Short**

WRS2, WRS3, WRS4, WRS5, WRS6, WRS6A, WRS8, WRS12, WRS16, WRS20, WRS24, WRS28, WRS32

Page 74 to 125



**CR**  
**Square Mount Isolator**

CR2, CR3, CR4, CR5, CR6, CR7, CR8

Page 126 to 139

# WR2

## Helical Isolator

### 1.59 mm (1/16") Diameter Cable

#### Features

- Rugged all metal construction
- Fail safe construction
- Long life and maintenance free
- Three axis capability (6 dof)
- High damping: C/cc ≈ 0.15 to 0.20

#### Operating temperature range

-130°C to +260°C

#### Material

- Cable: 300 Series SS per MIL-W-83420 or RR-W-410
- Screws: 300 Series SS per MS51959-12
- Inserts: 300 Series SS (alum bars only)
- Retainer bars: Standard: 6061-T6 Alum alloy/ Chem film IAW MIL-DTL-5541, TYPE II, Class 3

#### Note

- Mounting hole tolerances: ±0.25 mm
- Add 0.03 kg to Isolator weight for all stainless steel versions

#### On request

- Special materials, size, mounting holes, finish, etc. available

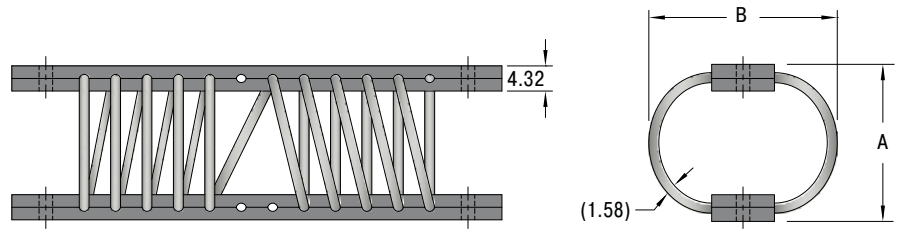
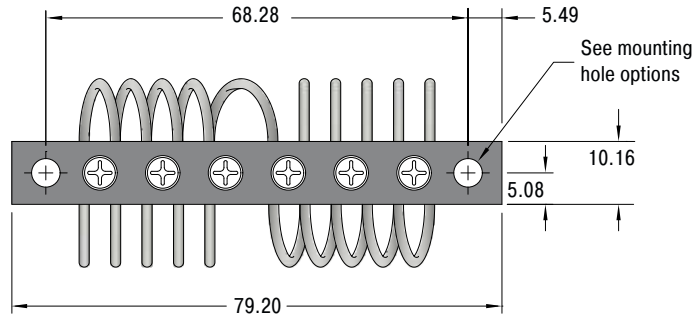

TYPES	A (+/- 0.8)		B	Compression			Shear/Roll (Average)			Weight kg
	mm	mm		Kv (Vibe) kN/m	Ks (Shock) kN/m	Deflection max. mm	Kv (Vibe) kN/m	Ks (Shock) kN/m	Deflection max. mm	
WR2-018-025-10	17.8	25.4	17	14	7.6	5.6	10	7.6	0.020	
WR2-020-028-10	20.3	27.9	15	12	10.2	4.9	8.8	10.2	0.023	
WR2-025-031-10	25.4	30.5	8.1	6.5	15.2	1.9	4.7	15.2	0.026	
WR2-028-033-10	27.9	33.0	5.3	4.0	17.8	1.4	4.2	17.8	0.028	
WR2-031-036-10	30.5	35.6	4.2	3.2	18.3	1.1	3.5	18.3	0.031	
WR2-033-038-10	33.0	38.1	3.5	2.5	22.9	0.7	3.2	22.9	0.034	

#### Ordering Example

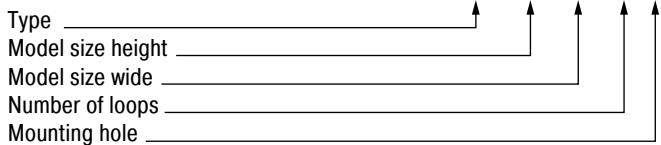

Mounting Hole Options	
<p>A</p>	<p>D</p>
<p>B</p>	<p>E</p>
<p>C</p>	<p>F</p>

Issue 07.2020 – Specifications subject to change

## Compression

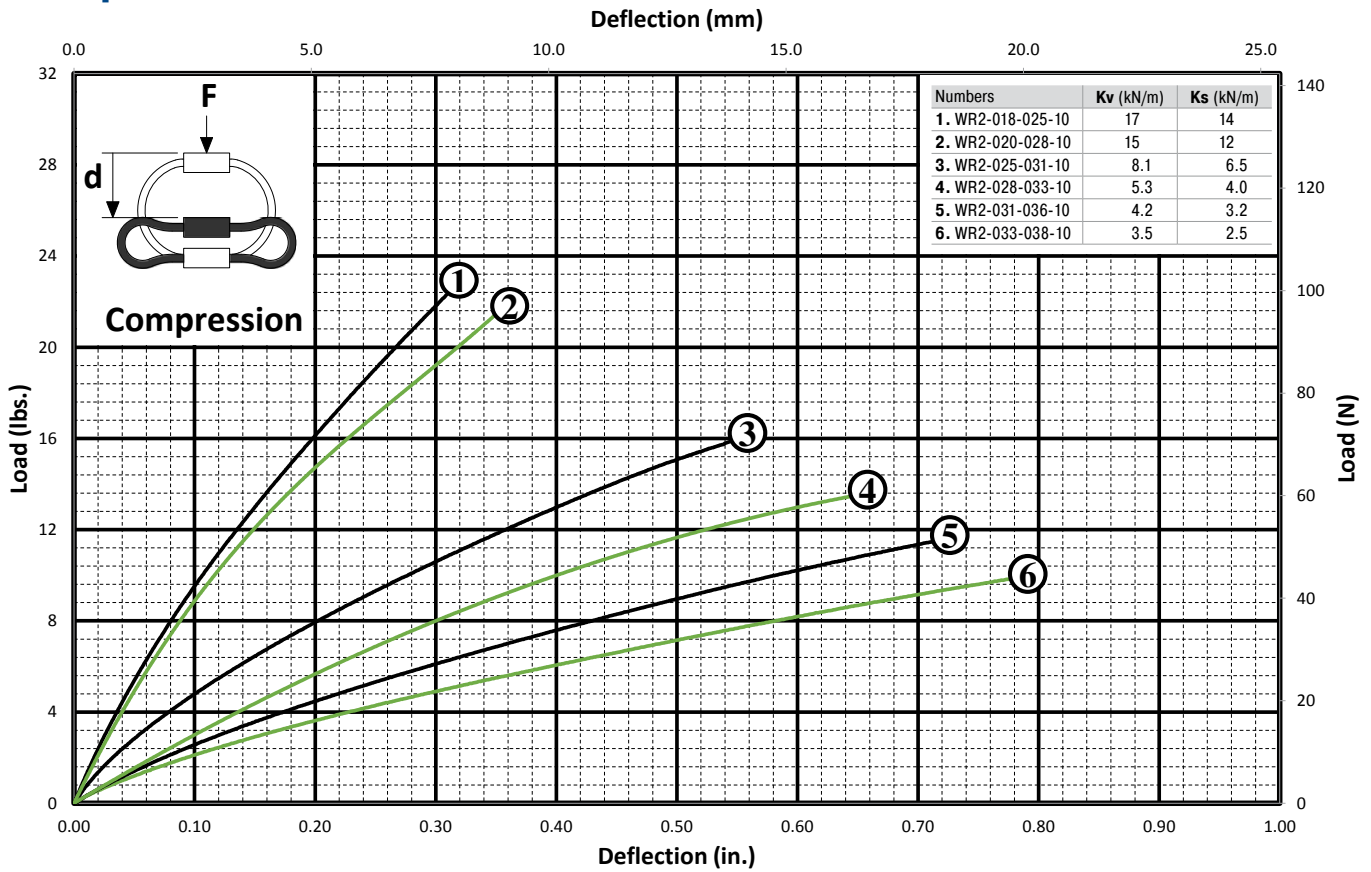

## Tension

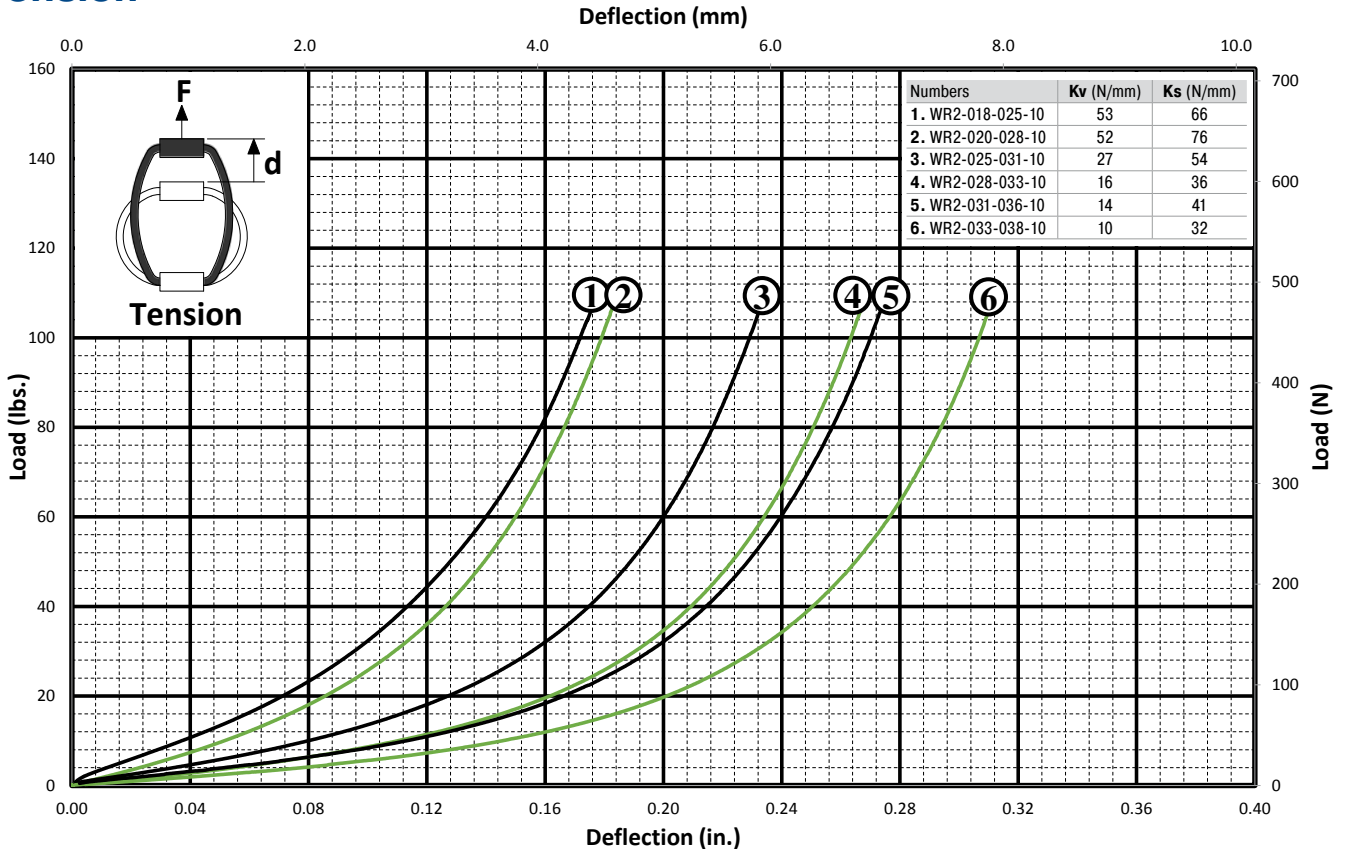

### Shear

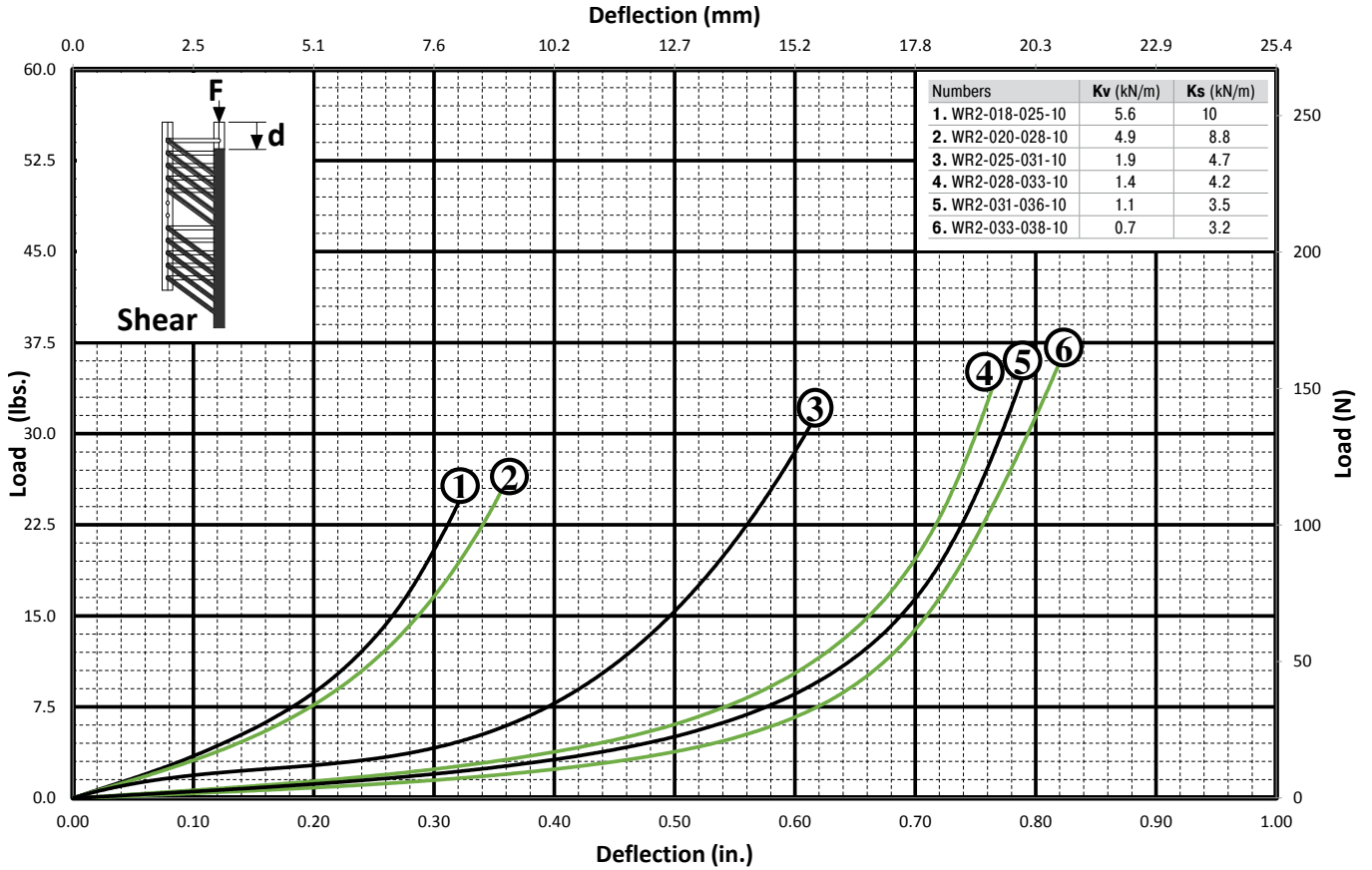

### Roll

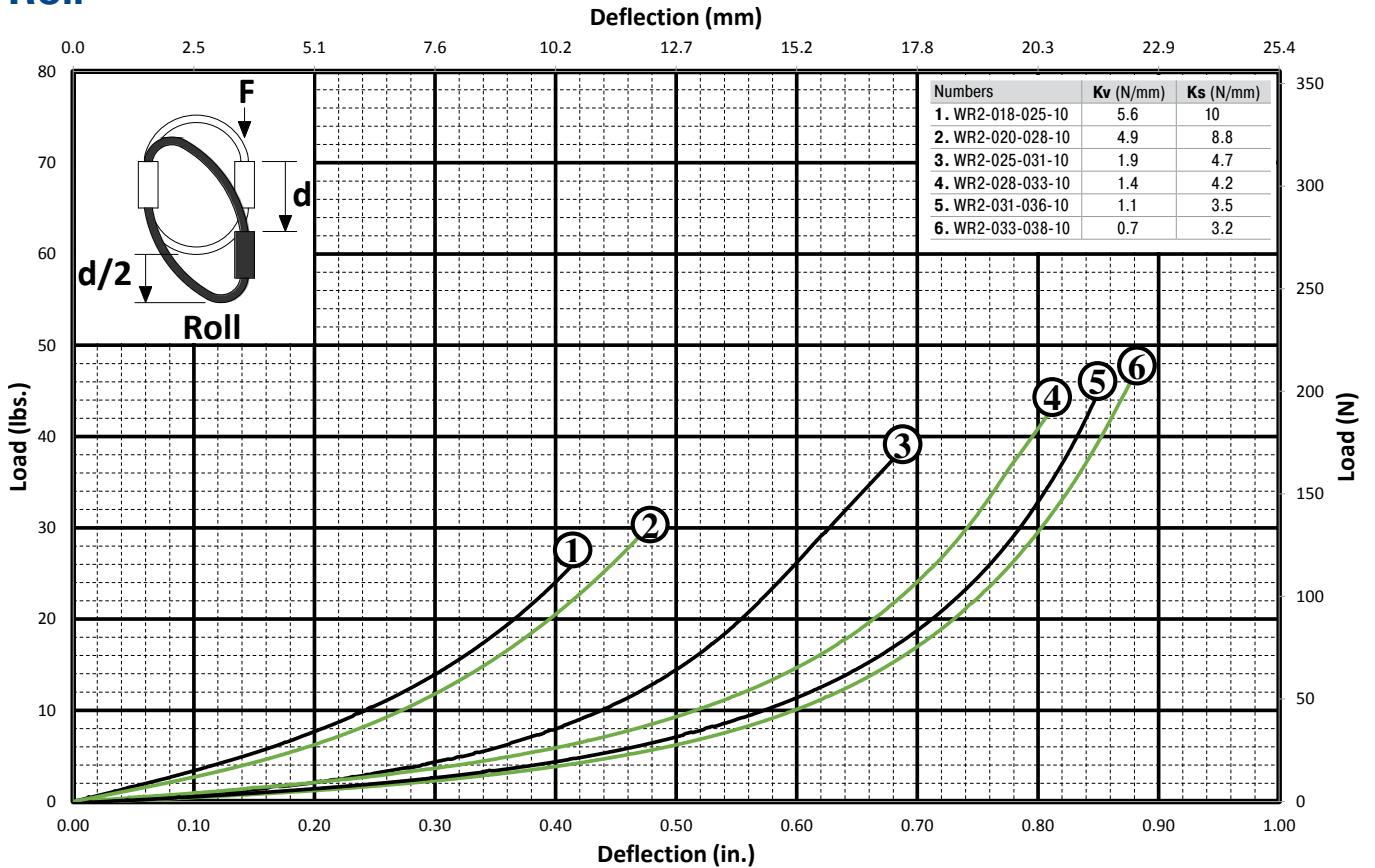

## 45° Compression/Roll

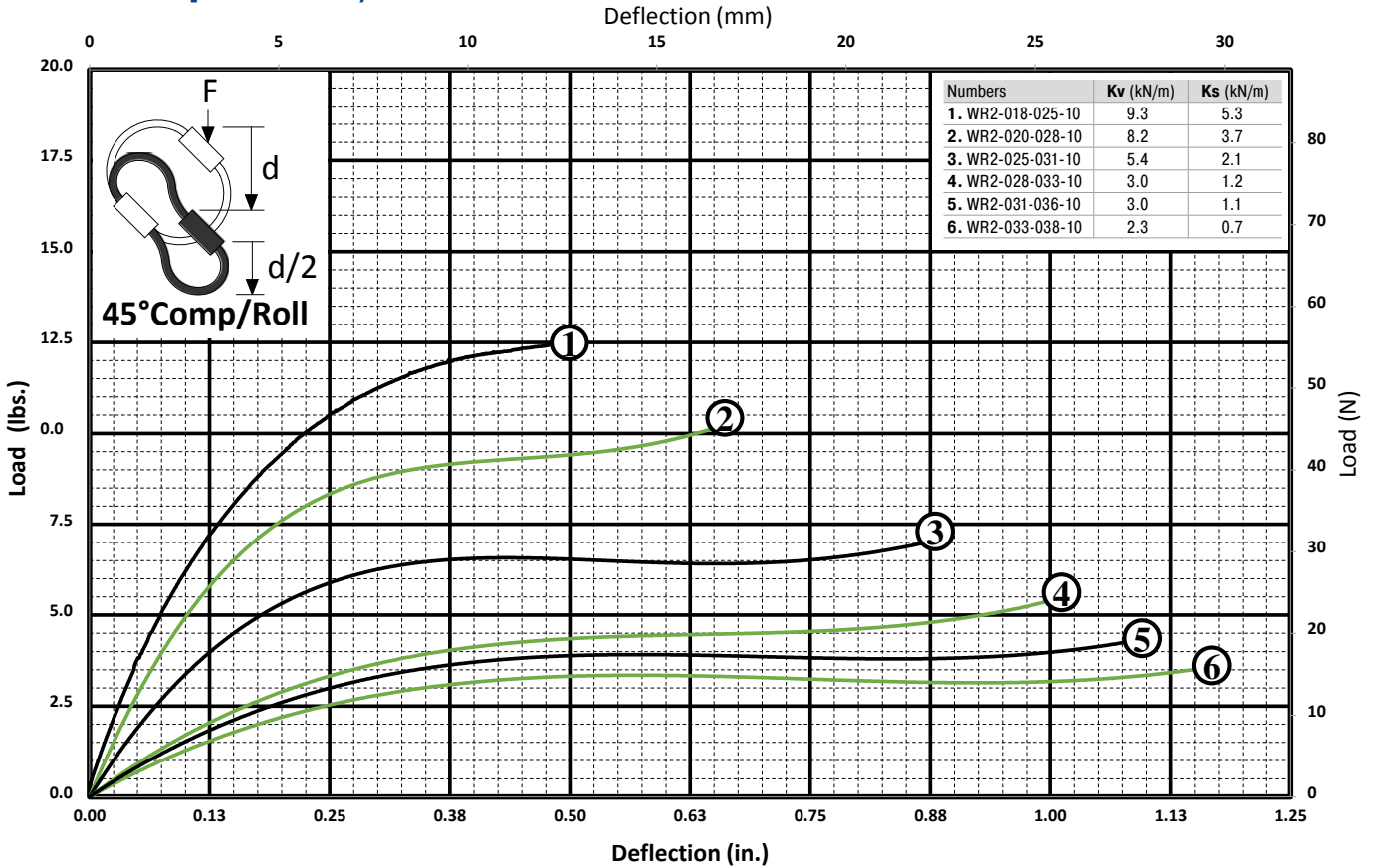

## 45° Tension/Roll

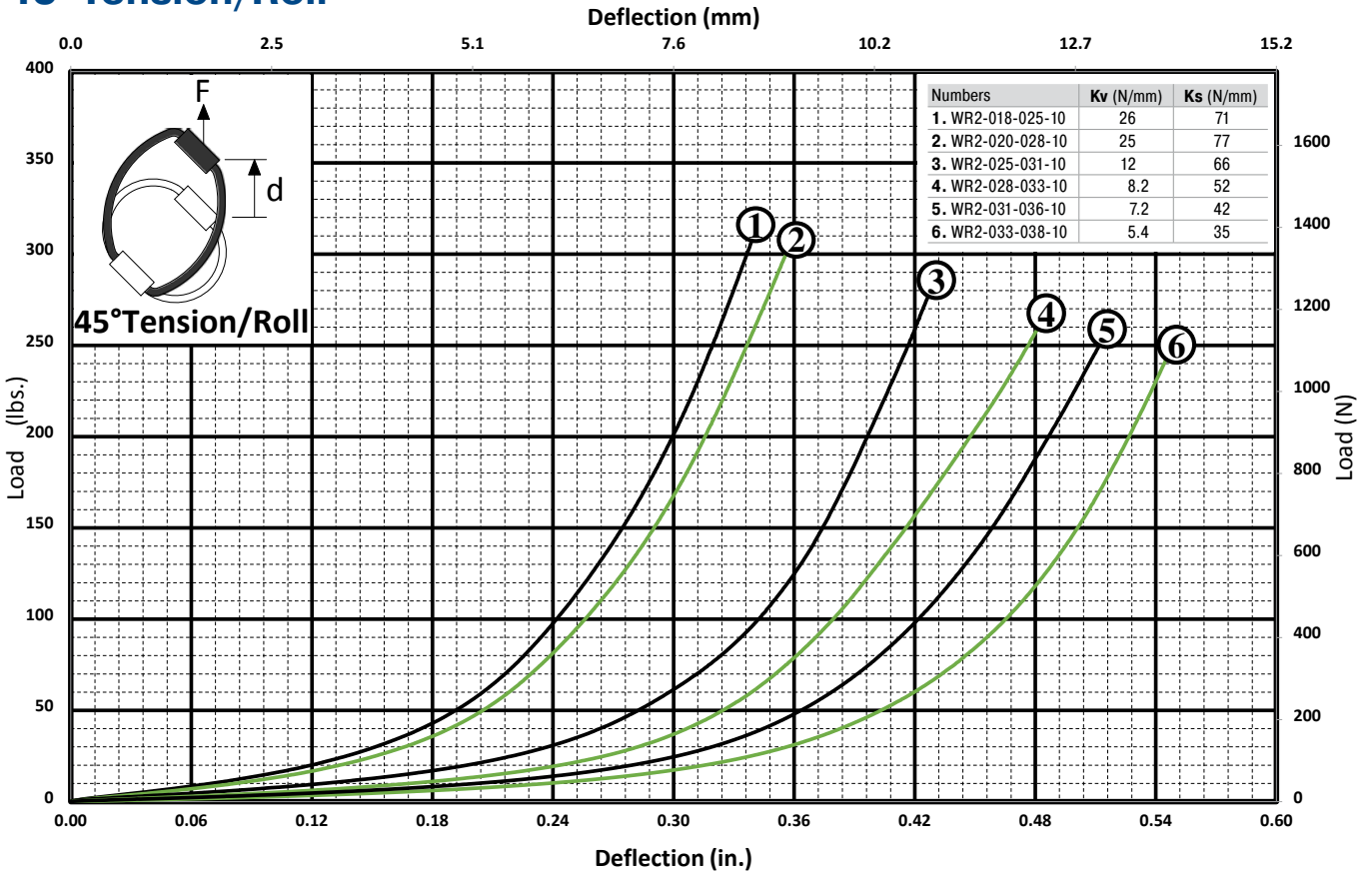

# WR3

## Helical Isolator

### 2.38 mm (3/32") Diameter Cable

#### Features

- Rugged all metal construction
- Fail safe construction
- Long life and maintenance free
- Three axis capability (6 dof)
- High damping: C/cc ≈ 0.15 to 0.20

#### Operating temperature range

-130°C to +260°C

#### Material

- Cable: 300 Series SS per MIL-W-83420 or RR-W-410
- Screws: 300 Series SS per MS51959-26
- Inserts: 300 Series SS (alum bars only)
- Retainer bars: Standard: 6061-T6 Alum alloy/ Chem film IAW MIL-DTL-5541, TYPE II, Class 3

#### Note

- Mounting hole tolerances: ±0.25 mm
- Add 0.07 kg to Isolator weight for all stainless steel versions

#### On request

- Special materials, size, mounting holes, finish, etc. available

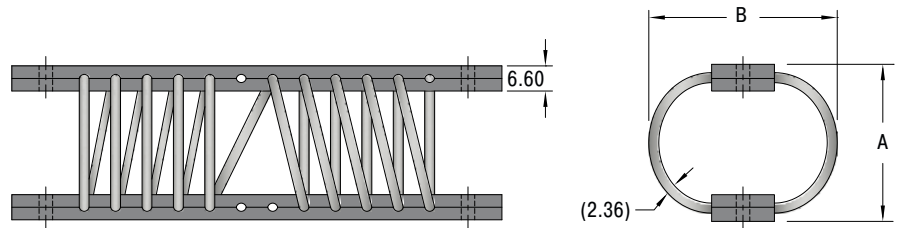
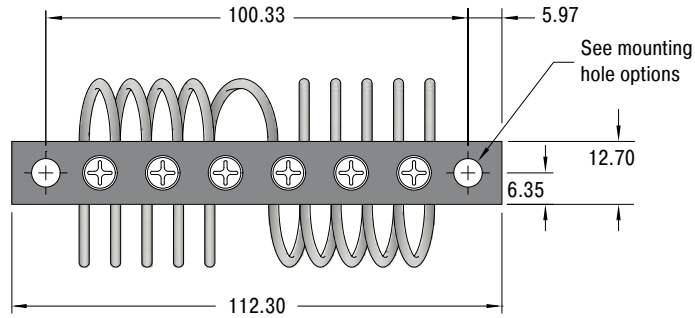

TYPES	A (+/- 0.8)		Compression			Shear/Roll (Average)			Weight kg
	mm	mm	Kv (Vibe) kN/m	Ks (Shock) kN/m	Deflection max. mm	Kv (Vibe) kN/m	Ks (Shock) kN/m	Deflection max. mm	
WR3-023-028-10	22.9	27.9	73	62	7.6	25	36	7.6	0.068
WR3-025-031-10	25.4	30.5	50	45	10.2	17	30	10.2	0.071
WR3-028-034-10	27.9	33.5	34	30	12.7	9.6	18	12.7	0.074
WR3-033-038-10	33.0	38.1	17	14	17.8	5.1	8.1	17.8	0.077
WR3-036-041-10	35.6	40.6	15	12	20.3	4.2	7.2	20.3	0.079
WR3-038-043-10	38.1	43.2	11	8.8	22.9	3.0	5.4	22.9	0.085

#### Ordering Example

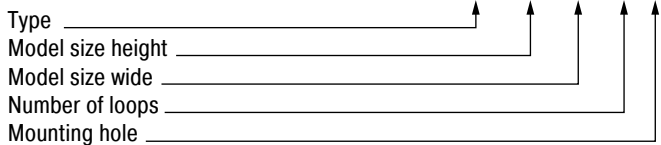

Mounting Hole Options	
<p>A</p>	<p>D</p>
<p>B</p>	<p>E</p>
<p>C</p>	<p>F</p>

Issue 07.2020 – Specifications subject to change



## Compression

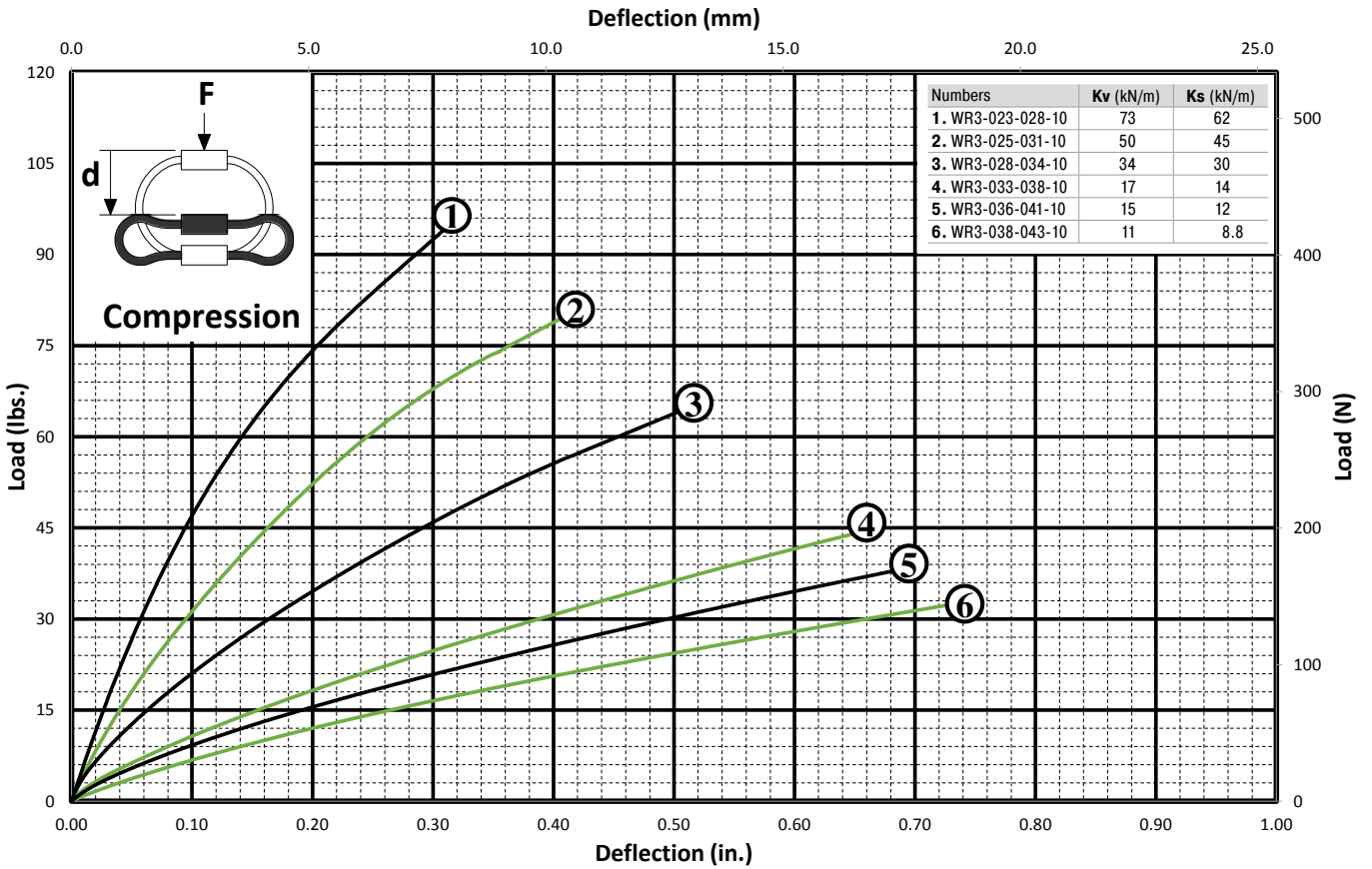

## Tension

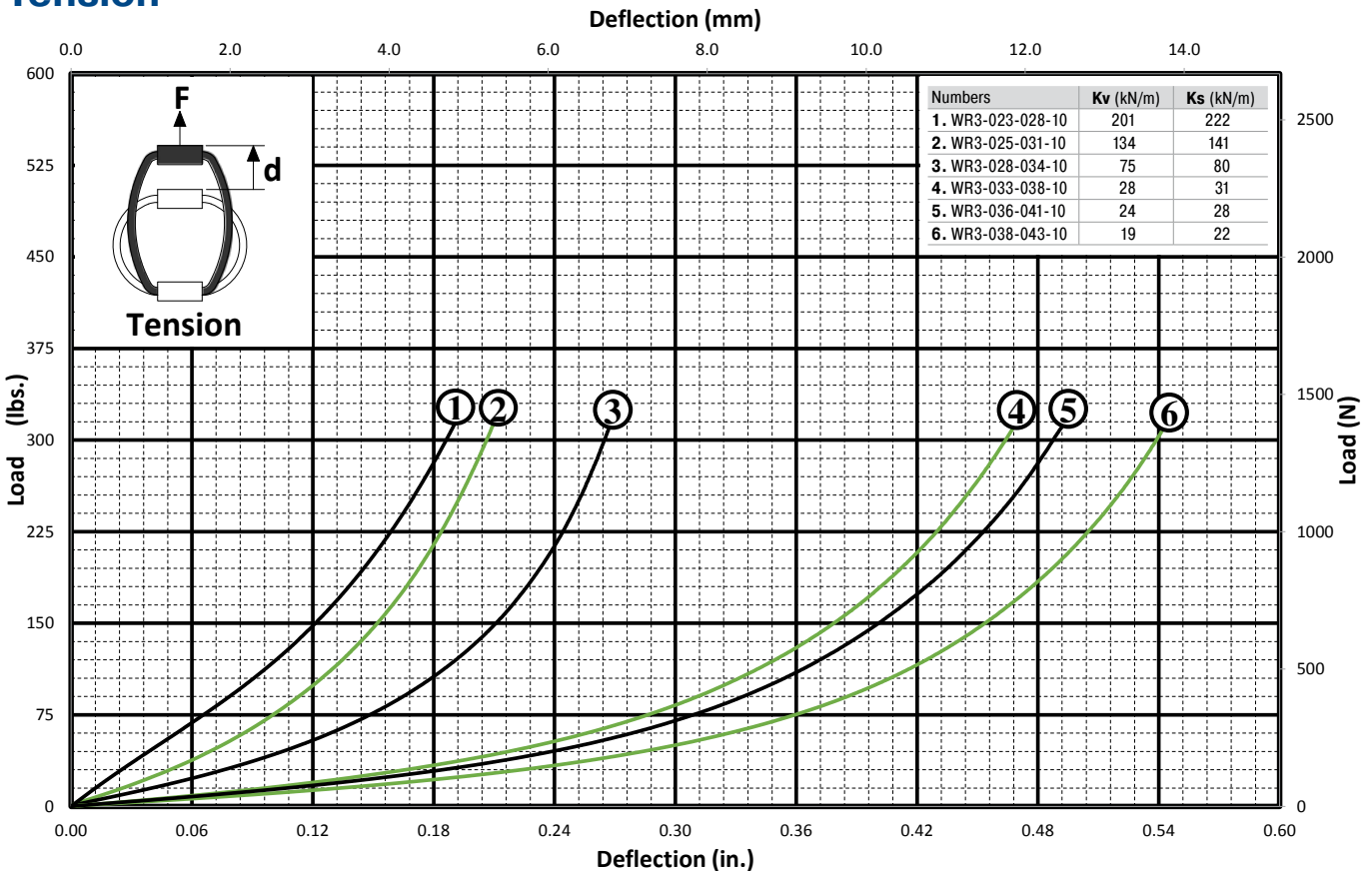

Issue 07.2020 – Specifications subject to change



### Shear

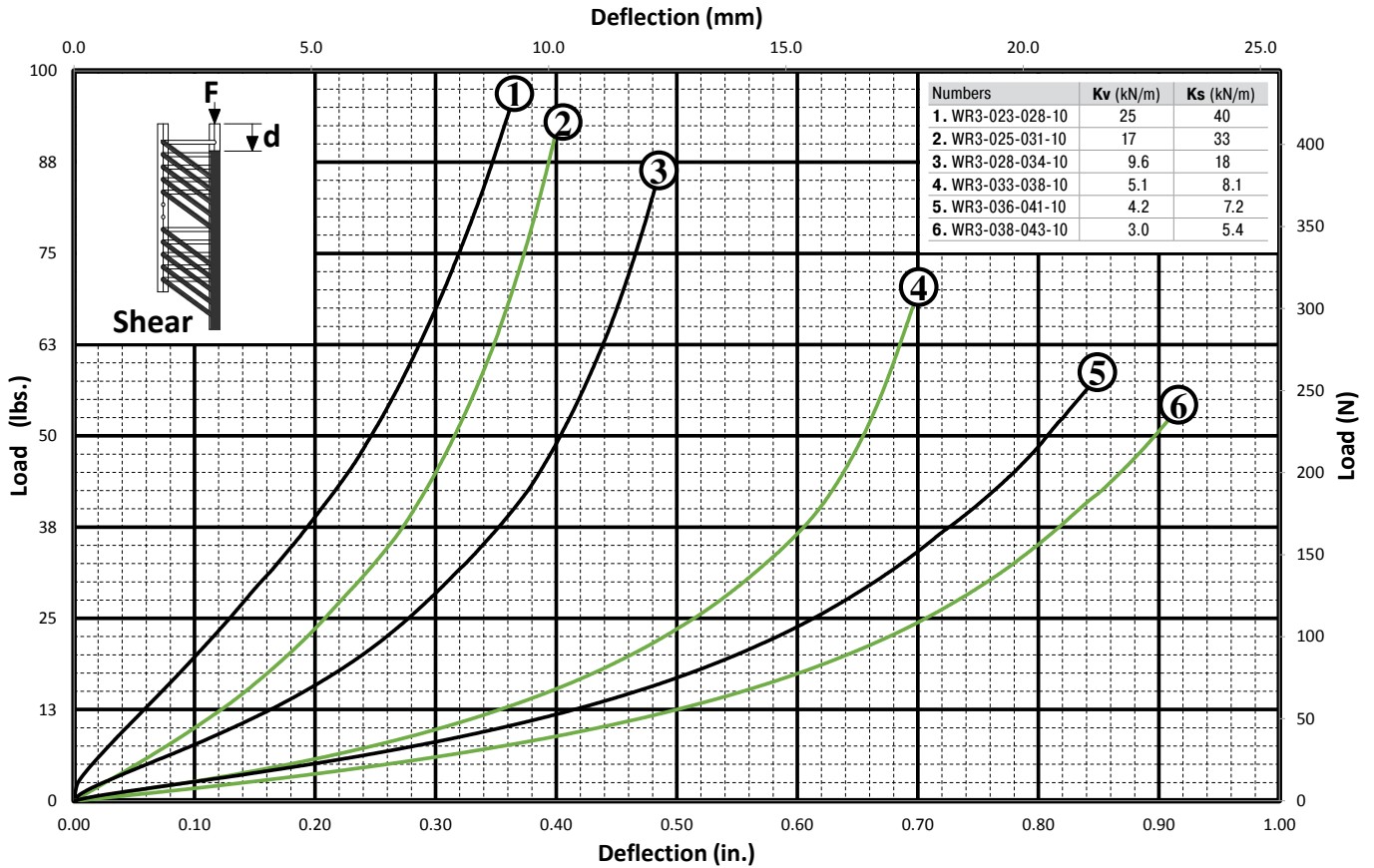

### Roll

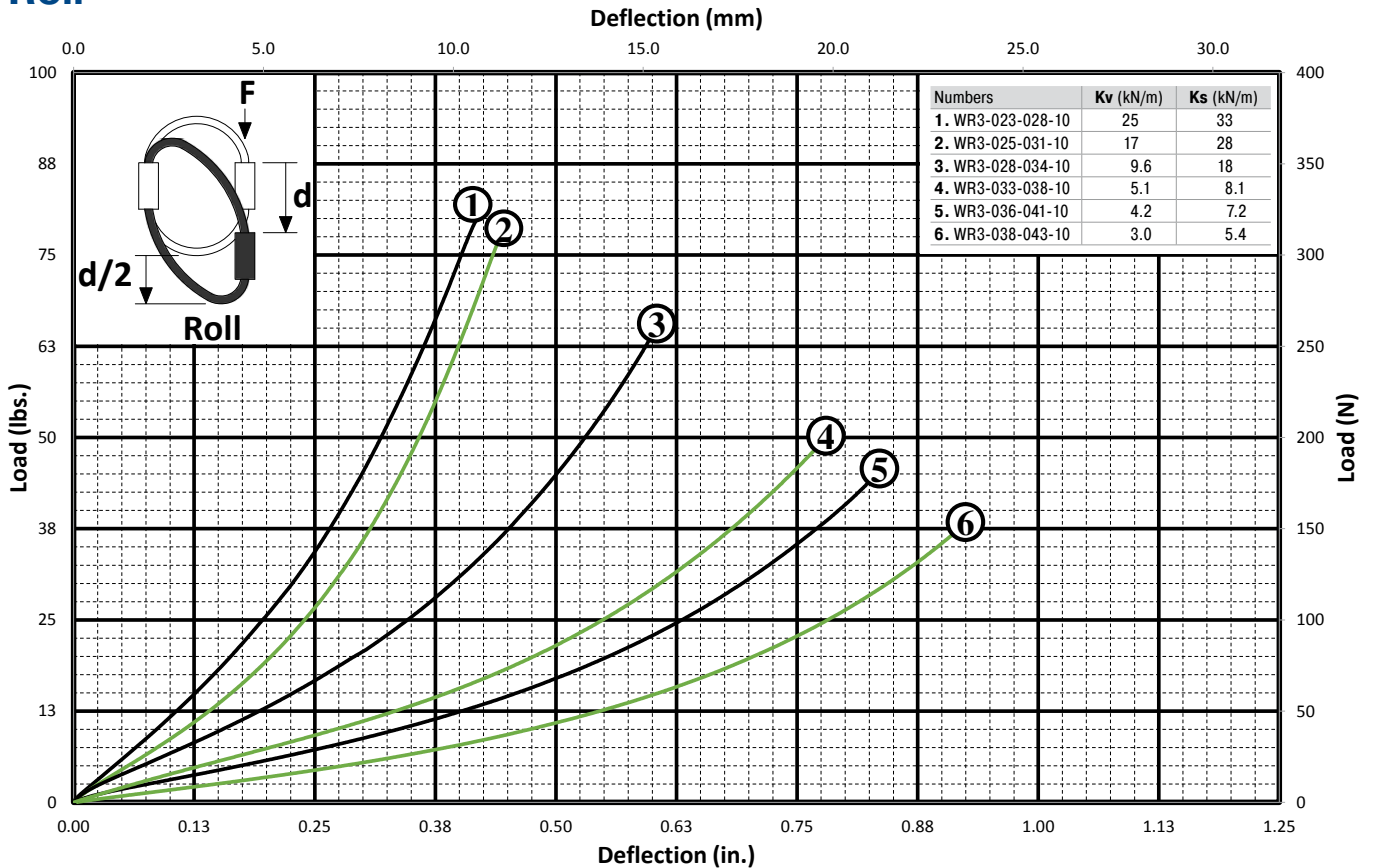

## 45° Compression/Roll

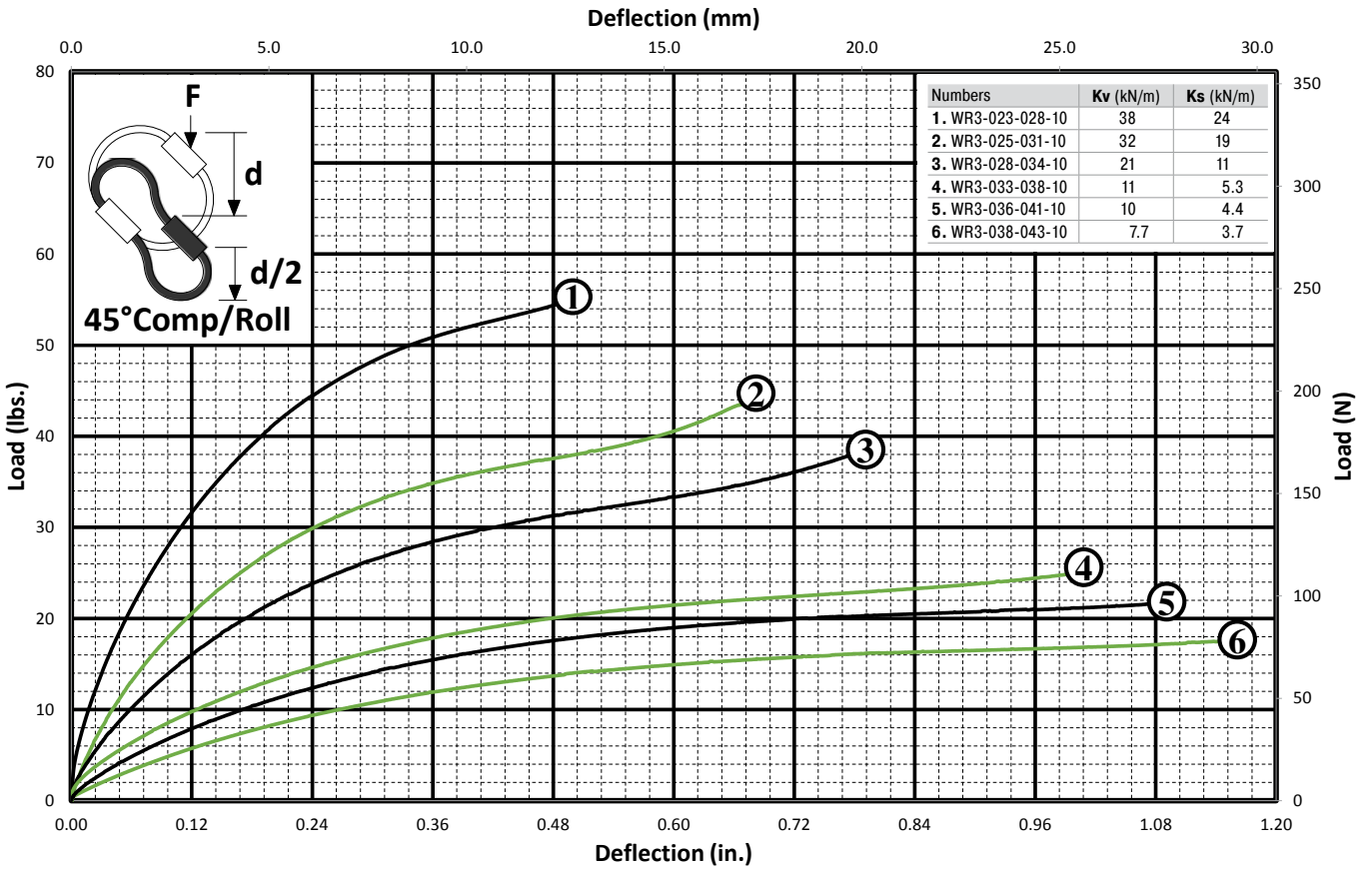

## 45° Tension/Roll

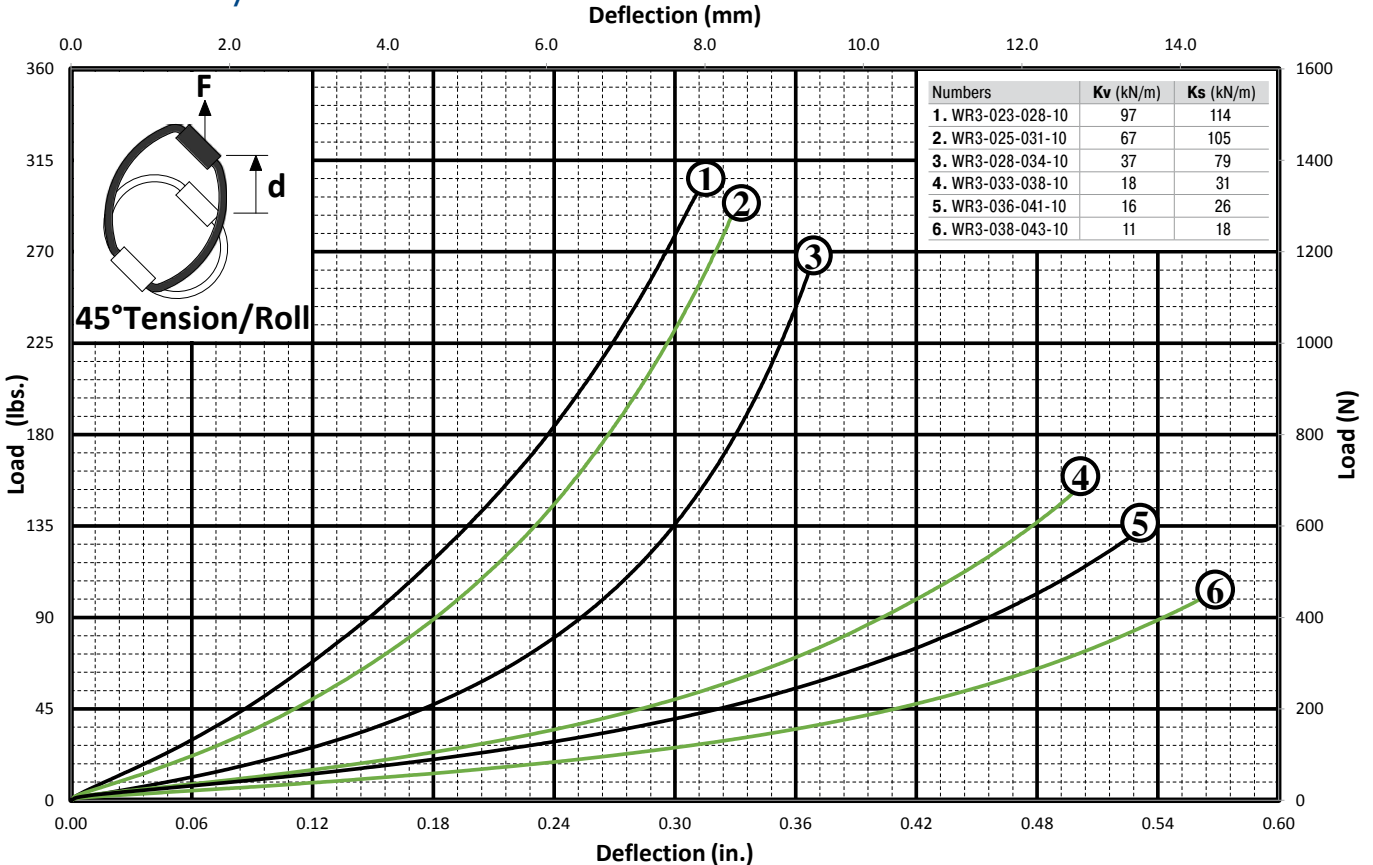

# WR4

## Helical Isolator

### 3.18 mm (1/8") Diameter Cable

#### Features

- Rugged all metal construction
- Fail safe construction
- Long life and maintenance free
- Three axis capability (6 dof)
- High damping: C/cc ≈ 0.15 to 0.20

#### Operating temperature range

-130°C to +260°C

#### Material

- Cable: 300 Series SS per MIL-W-83420 or RR-W-410
- Screws: 300 Series SS per MS51959-42
- Inserts: 300 Series SS (alum bars only)
- Retainer bars: Standard: 6061-T6 Alum alloy/ Chem film IAW MIL-DTL-5541, TYPE II, Class 3

#### Note

- Mounting hole tolerances: ±0.25 mm
- Add 0.12 kg to Isolator weight for all stainless steel versions

#### On request

- Special materials, size, mounting holes, finish, etc. available

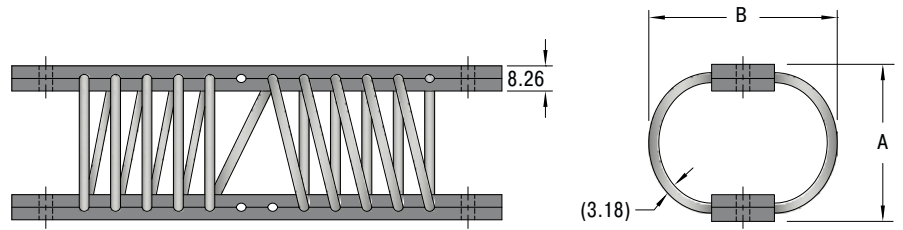
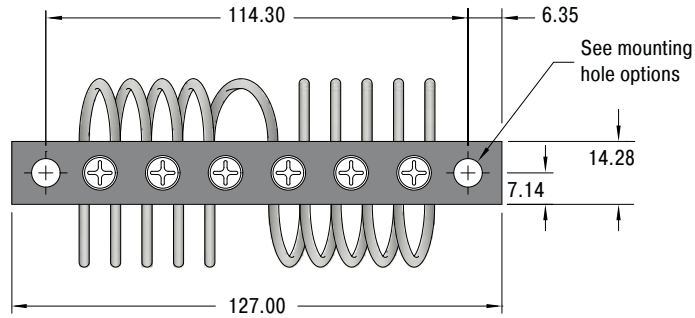

TYPES	A (+/- 0.8)		Compression			Shear/Roll (Average)			Weight kg
	mm	mm	Kv (Vibe) kN/m	Ks (Shock) kN/m	Deflection max. mm	Kv (Vibe) kN/m	Ks (Shock) kN/m	Deflection max. mm	
WR4-028-036-10	27.9	35.6	88	83	8.9	31	37	8.9	0.114
WR4-031-038-10	30.5	38.1	86	73	11.4	26	34	11.4	0.116
WR4-033-041-10	33.0	40.6	67	52	14.0	21	29	14.0	0.119
WR4-036-043-10	35.6	43.2	50	41	16.5	15	22	16.5	0.122
WR4-038-046-10	38.1	45.7	40	32	19.1	13	20	19.1	0.125
WR4-041-048-10	40.6	48.2	34	25	21.6	9.5	15	21.6	0.128

#### Ordering Example

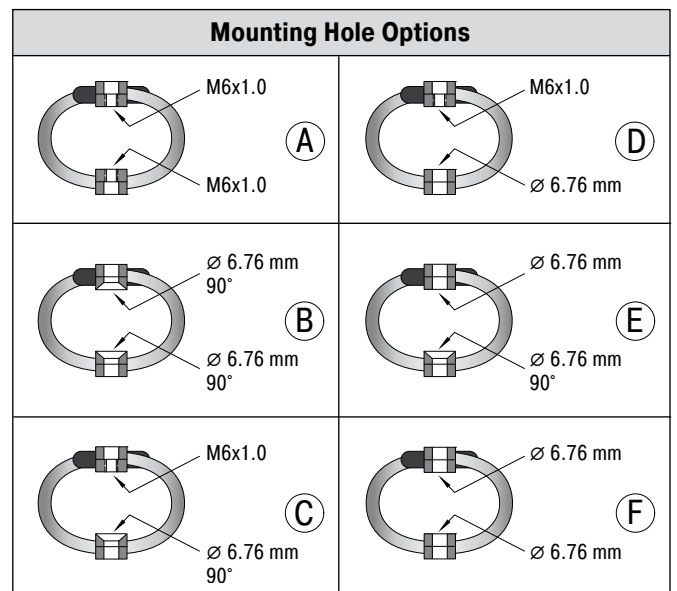
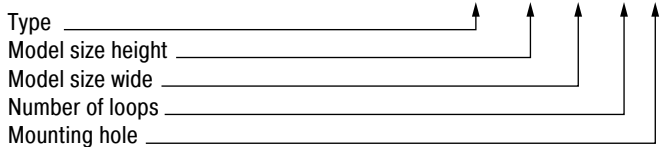

Issue 07.2020 – Specifications subject to change

## Compression

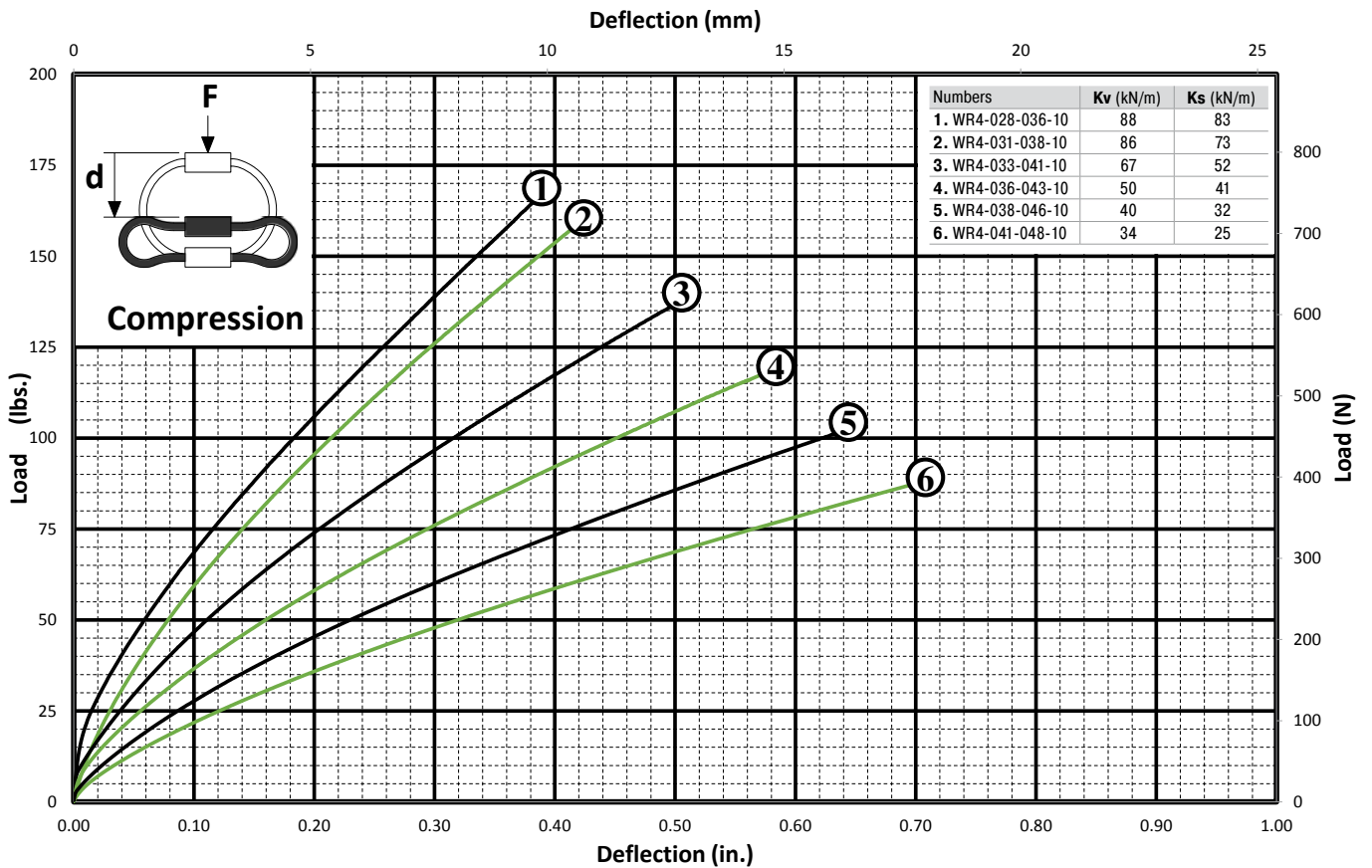

## Tension

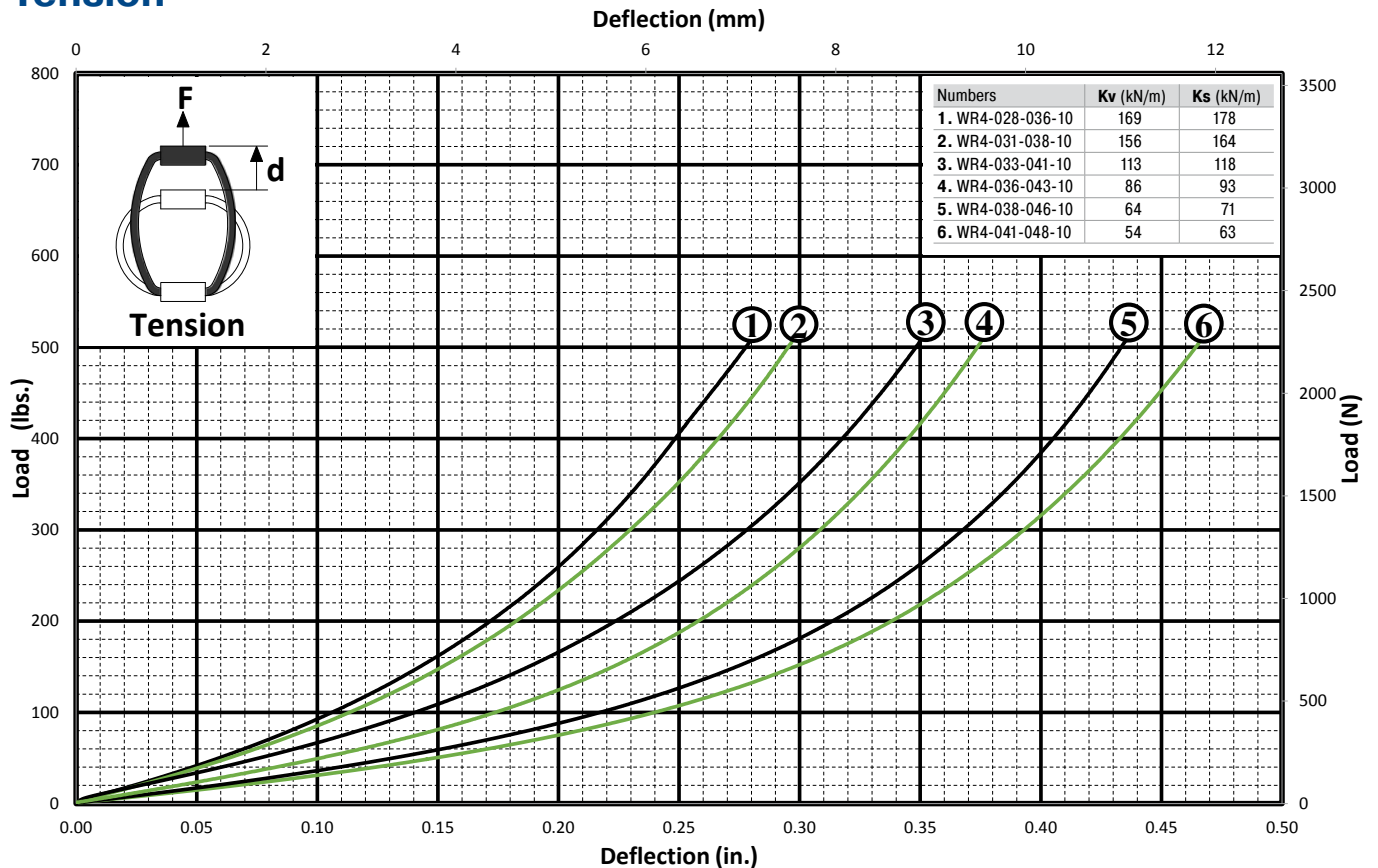

Issue 07.2020 – Specifications subject to change

### Shear

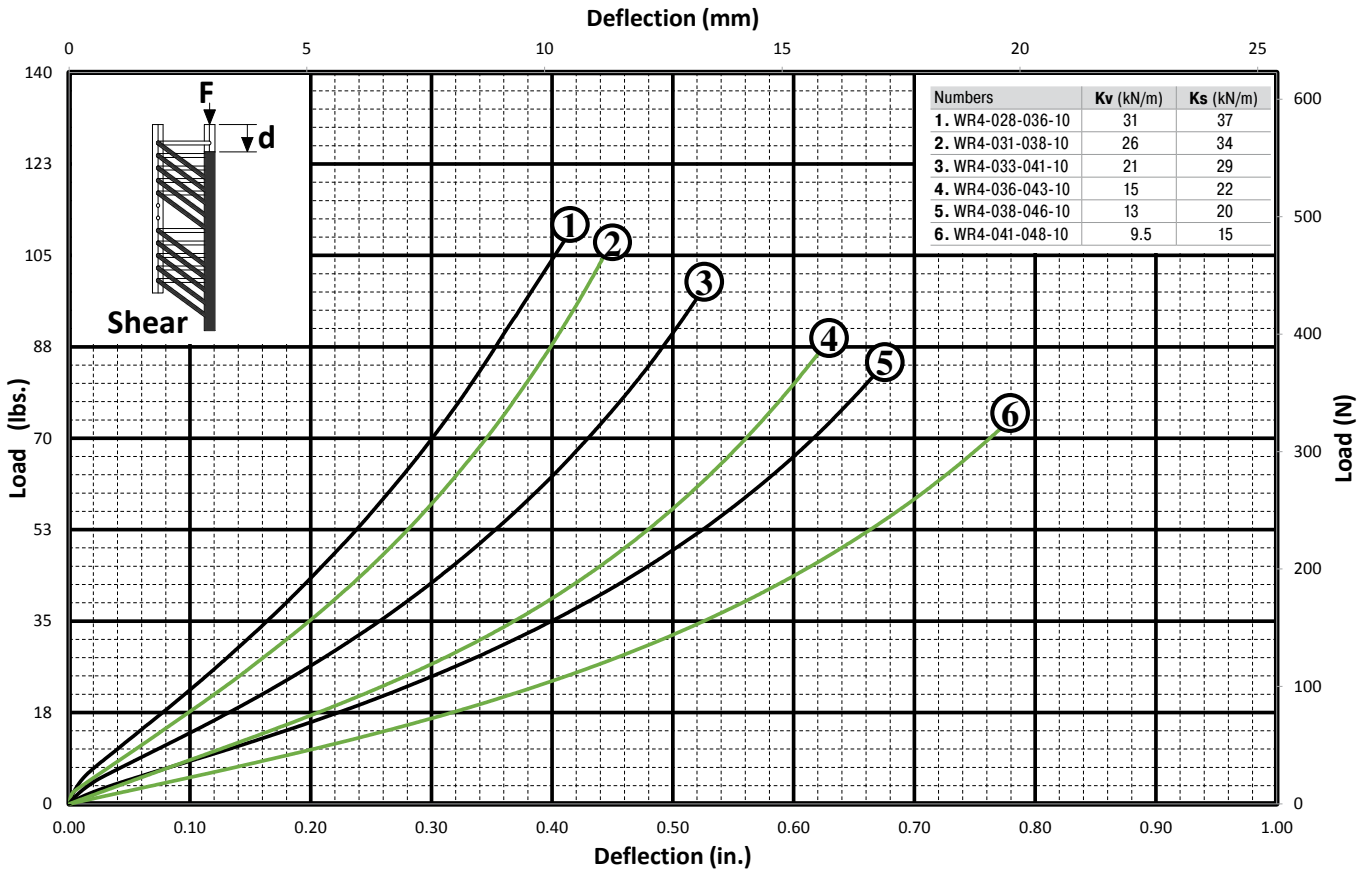

### Roll

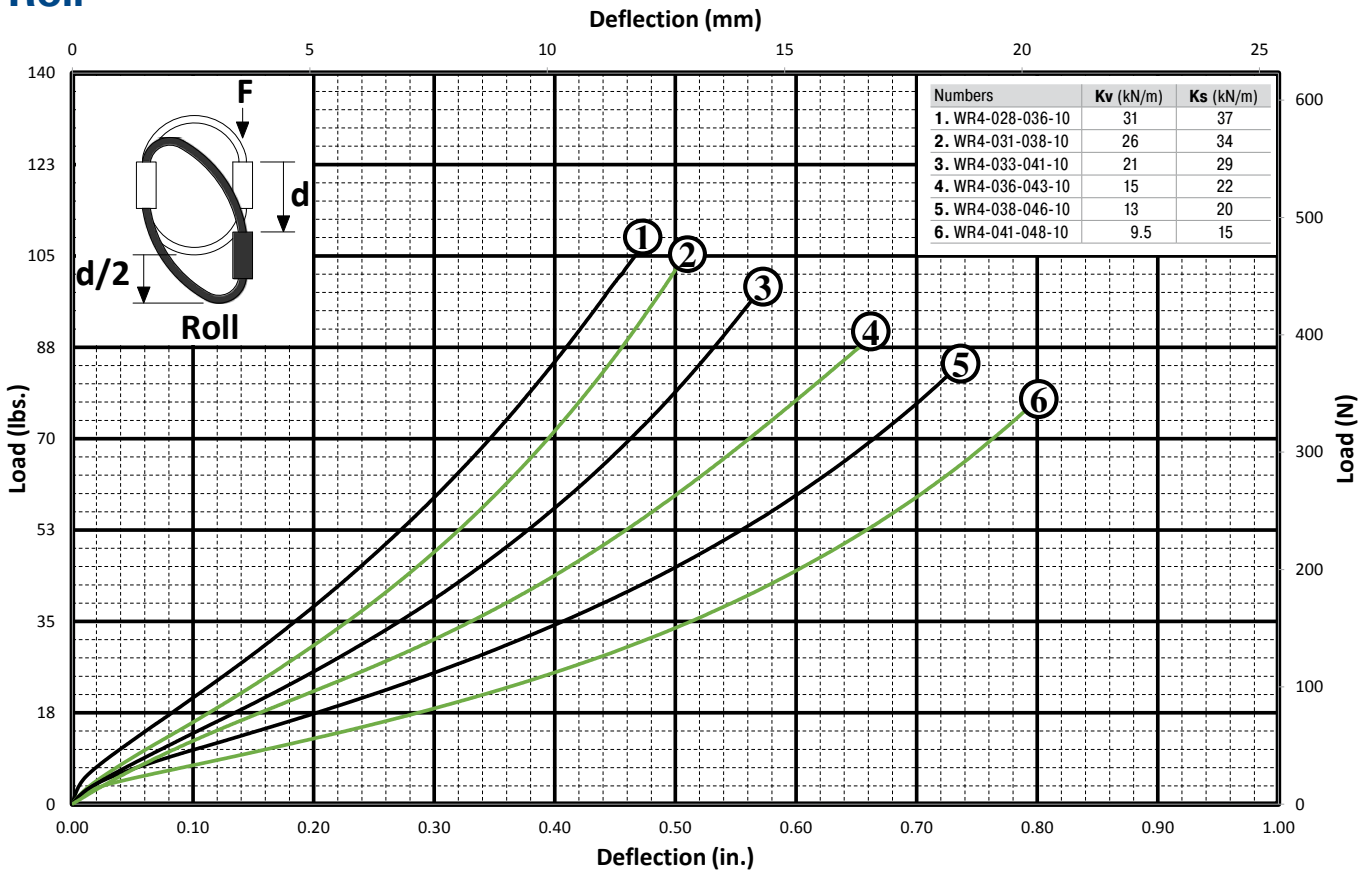



### 45° Compression/Roll

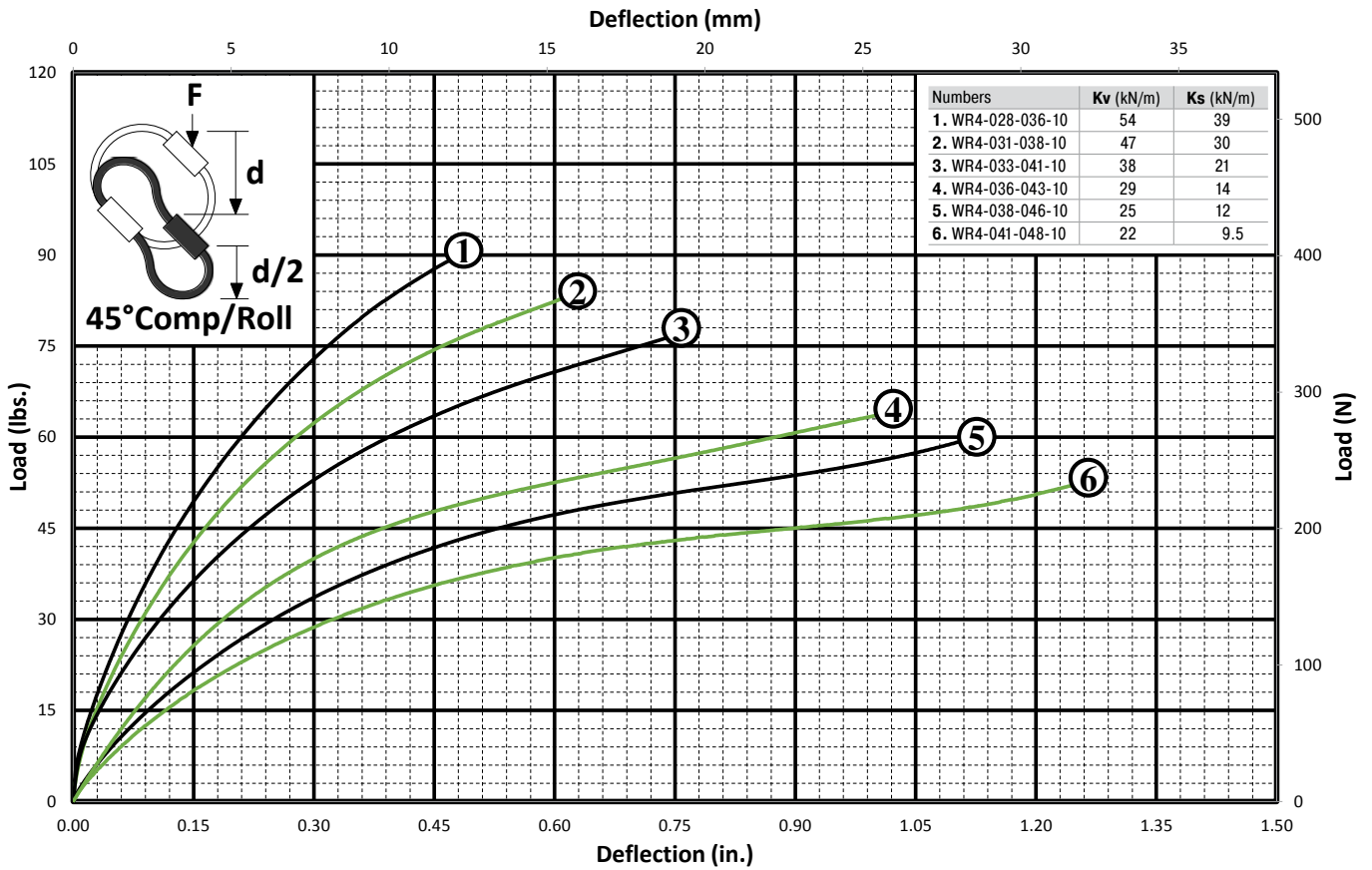

### 45° Tension/Roll

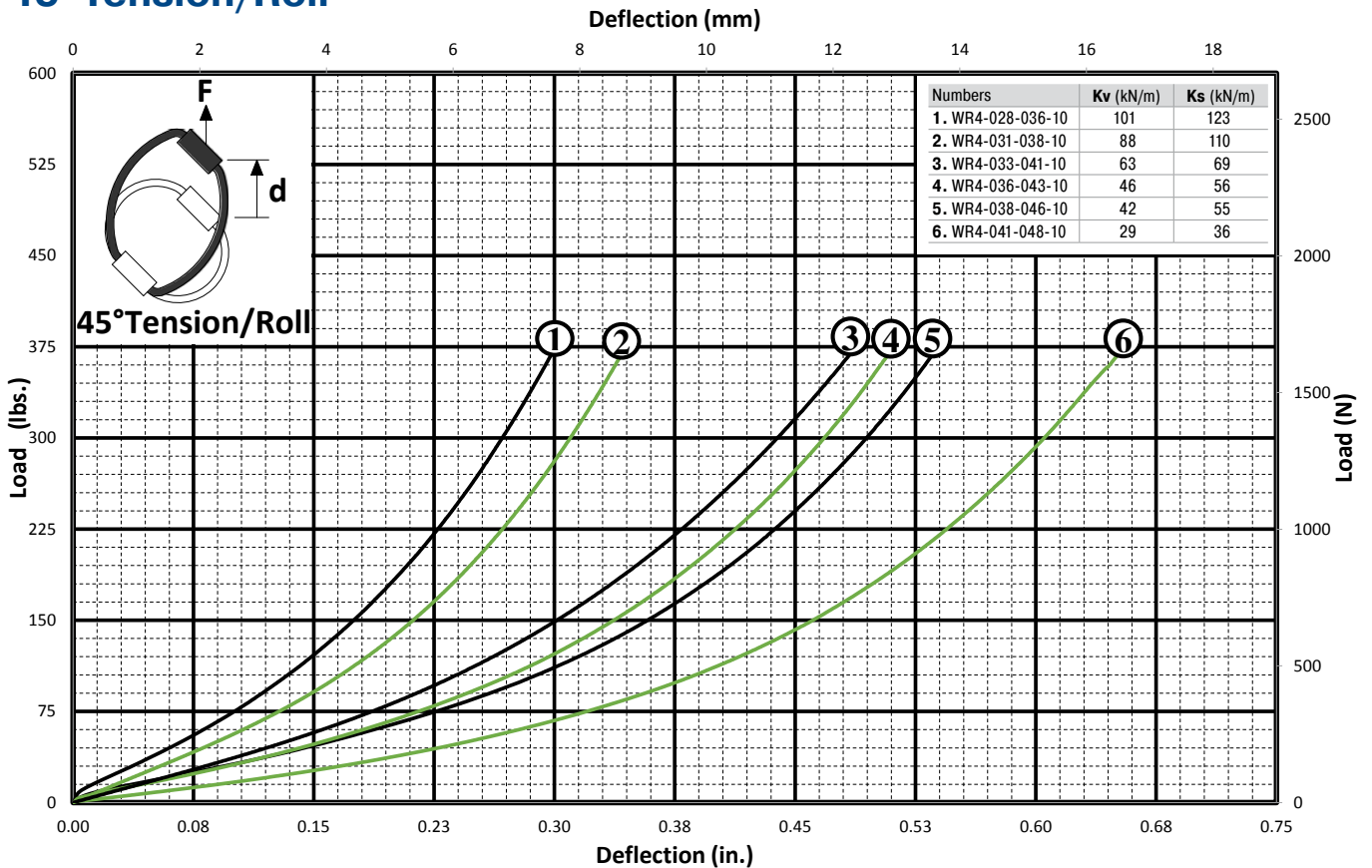

# WR5

## Helical Isolator

### 3.97 mm (5/32") Diameter Cable

#### Features

- Rugged all metal construction
- Fail safe construction
- Long life and maintenance free
- Three axis capability (6 dof)
- High damping: C/cc ≈ 0.15 to 0.20

#### Operating temperature range

-130°C to +260°C

#### Material

- Cable: 300 Series SS per MIL-W-83420 or RR-W-410
- Screws: 300 Series SS per MS51959-42
- Inserts: 300 Series SS (alum bars only)
- Retainer bars: Standard: 6061-T6 Alum alloy/ Chem film IAW MIL-DTL-5541, TYPE II, Class 3

#### Note

- Mounting hole tolerances: ±0.25 mm
- Add 0.11 kg to Isolator weight for all stainless steel versions

#### On request

- Special materials, size, mounting holes, finish, etc. available

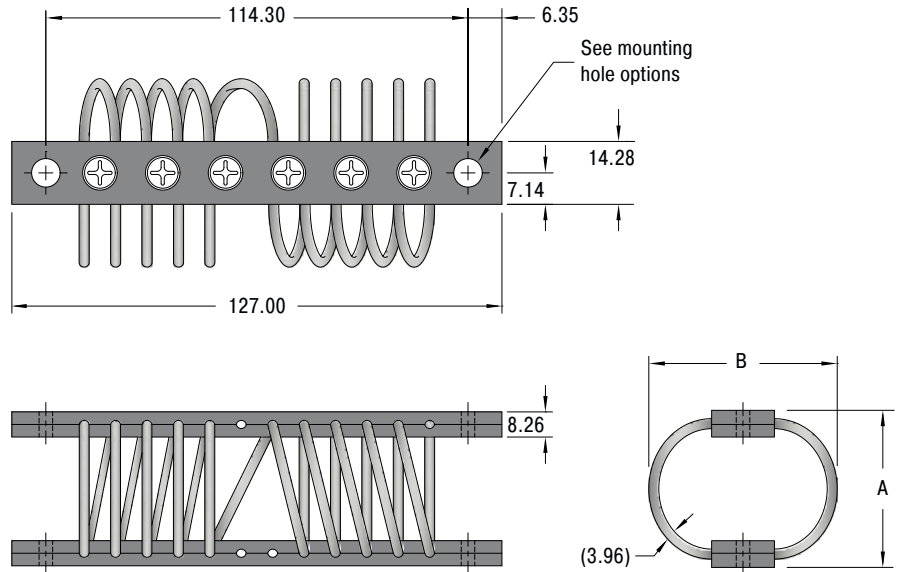

TYPES	A (+/- 0.8)		Compression			Shear/Roll (Average)			Weight kg
	mm	mm	Kv (Vibe) kN/m	Ks (Shock) kN/m	Deflection max. mm	Kv (Vibe) kN/m	Ks (Shock) kN/m	Deflection max. mm	
WR5-028-036-10	27.9	35.6	228	210	8.9	81	96	8.9	0.131
WR5-031-038-10	30.5	38.1	197	176	11.4	62	75	11.4	0.136
WR5-033-041-10	33.0	40.6	137	117	14.0	43	51	14.0	0.148
WR5-036-043-10	35.6	43.2	117	93	16.5	33	43	16.5	0.148
WR5-038-046-10	38.1	45.7	90	72	19.1	22	35	19.1	0.153
WR5-041-048-10	40.6	48.2	69	52	21.6	19	27	21.6	0.153

#### Ordering Example

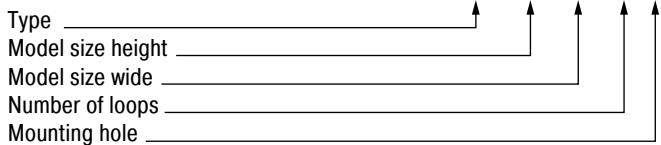

Mounting Hole Options	
<p>A</p>	<p>D</p>
<p>B</p>	<p>E</p>
<p>C</p>	<p>F</p>



## Compression

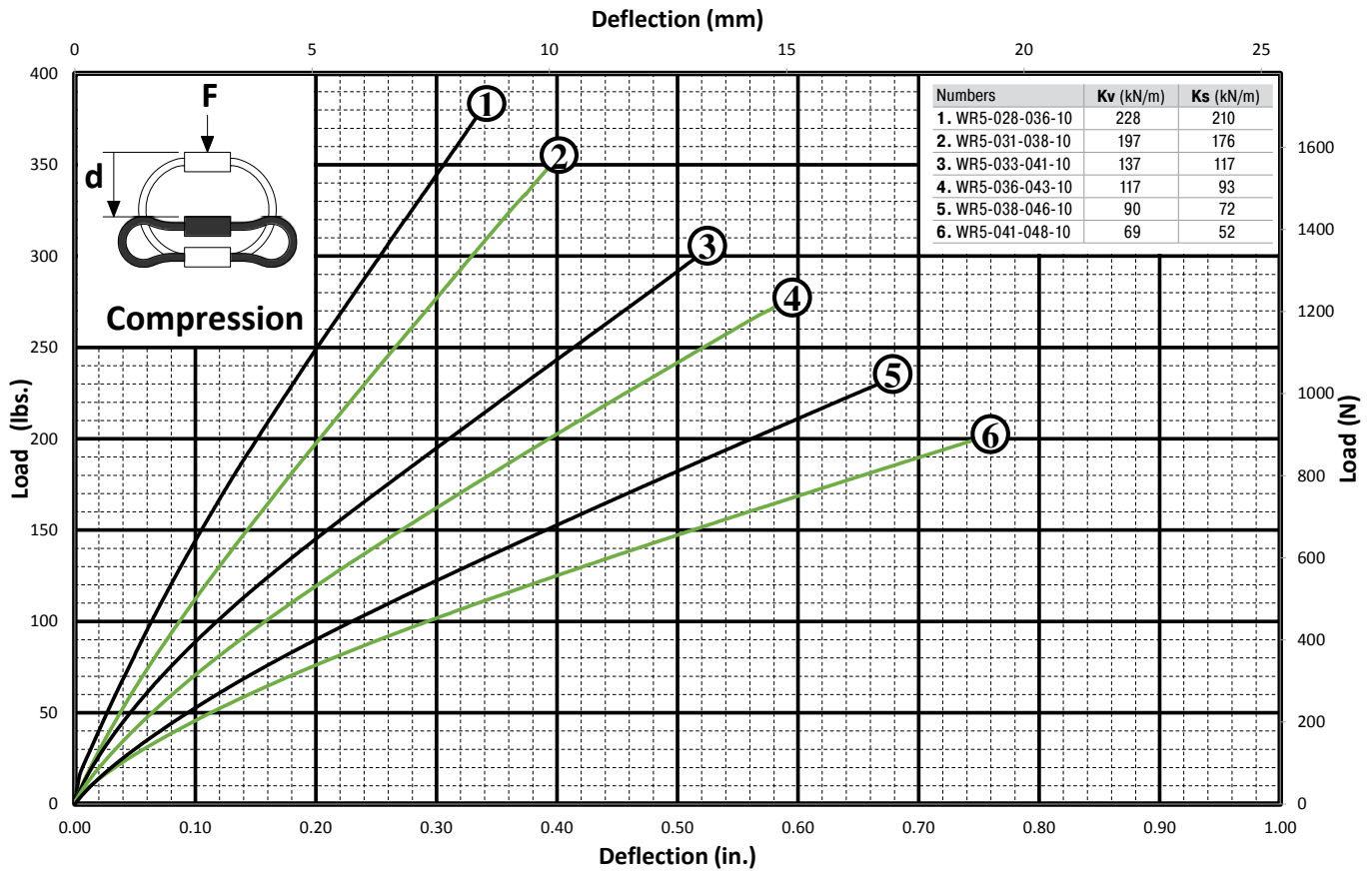

## Tension

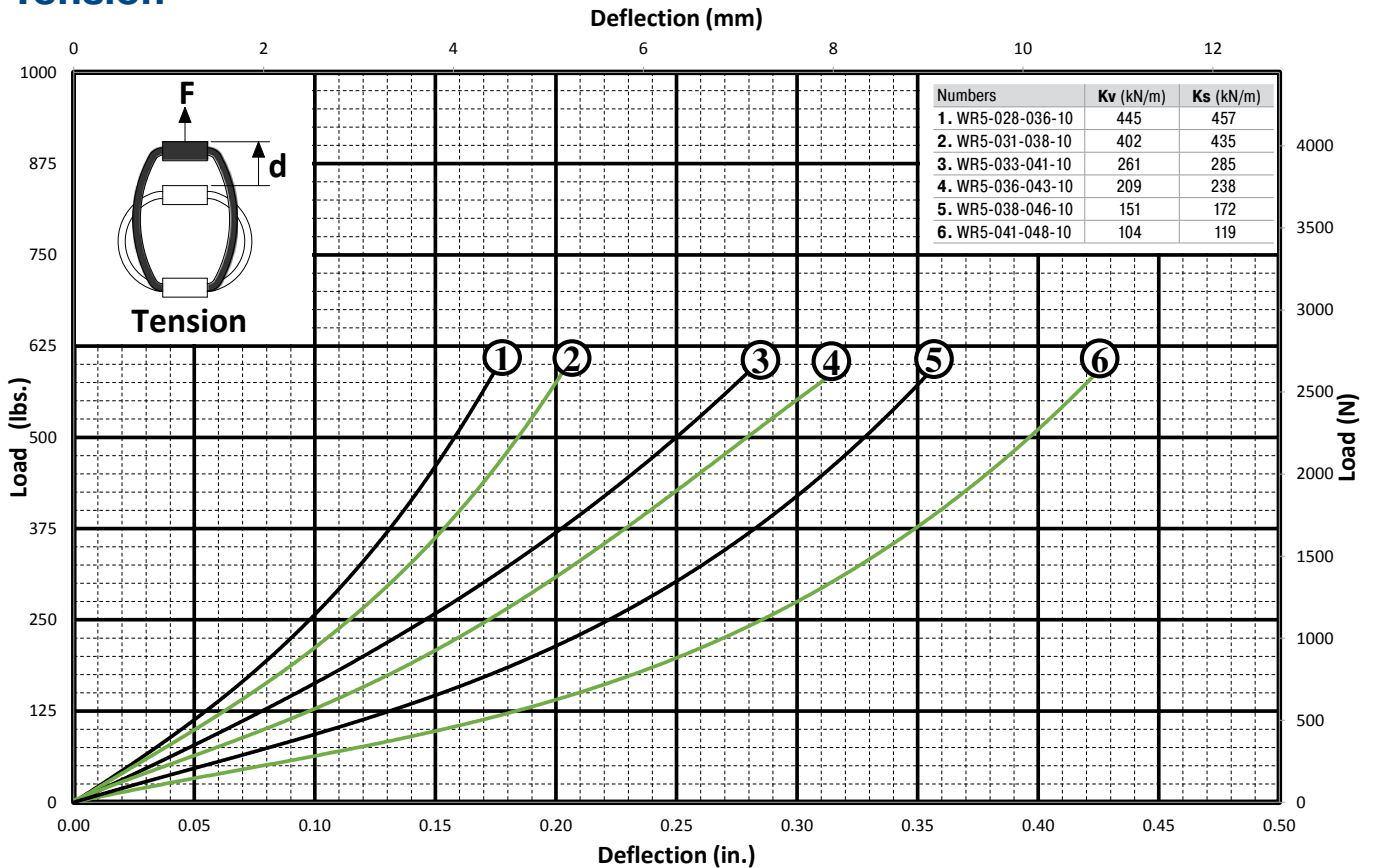

### Shear

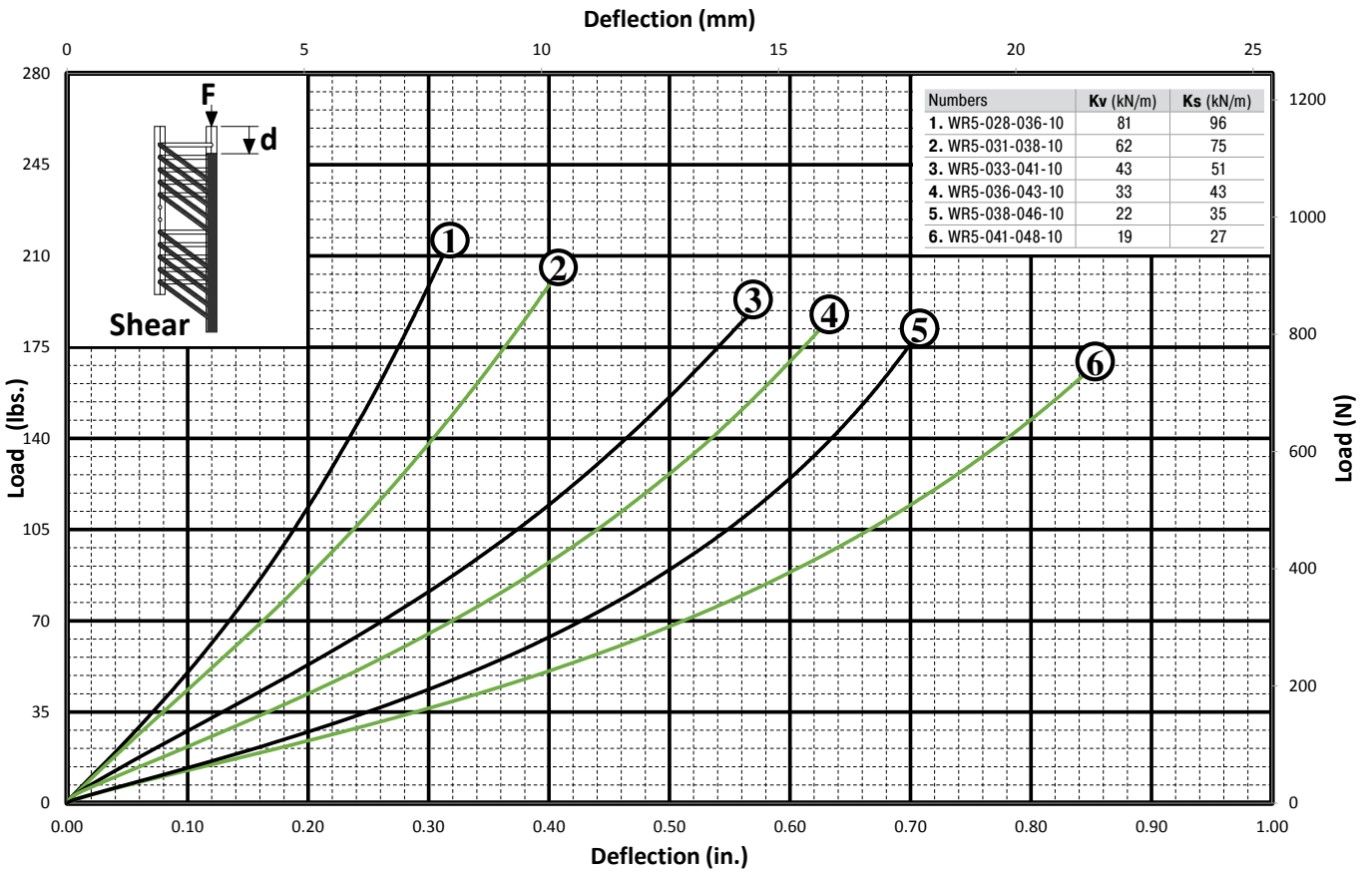

### Roll

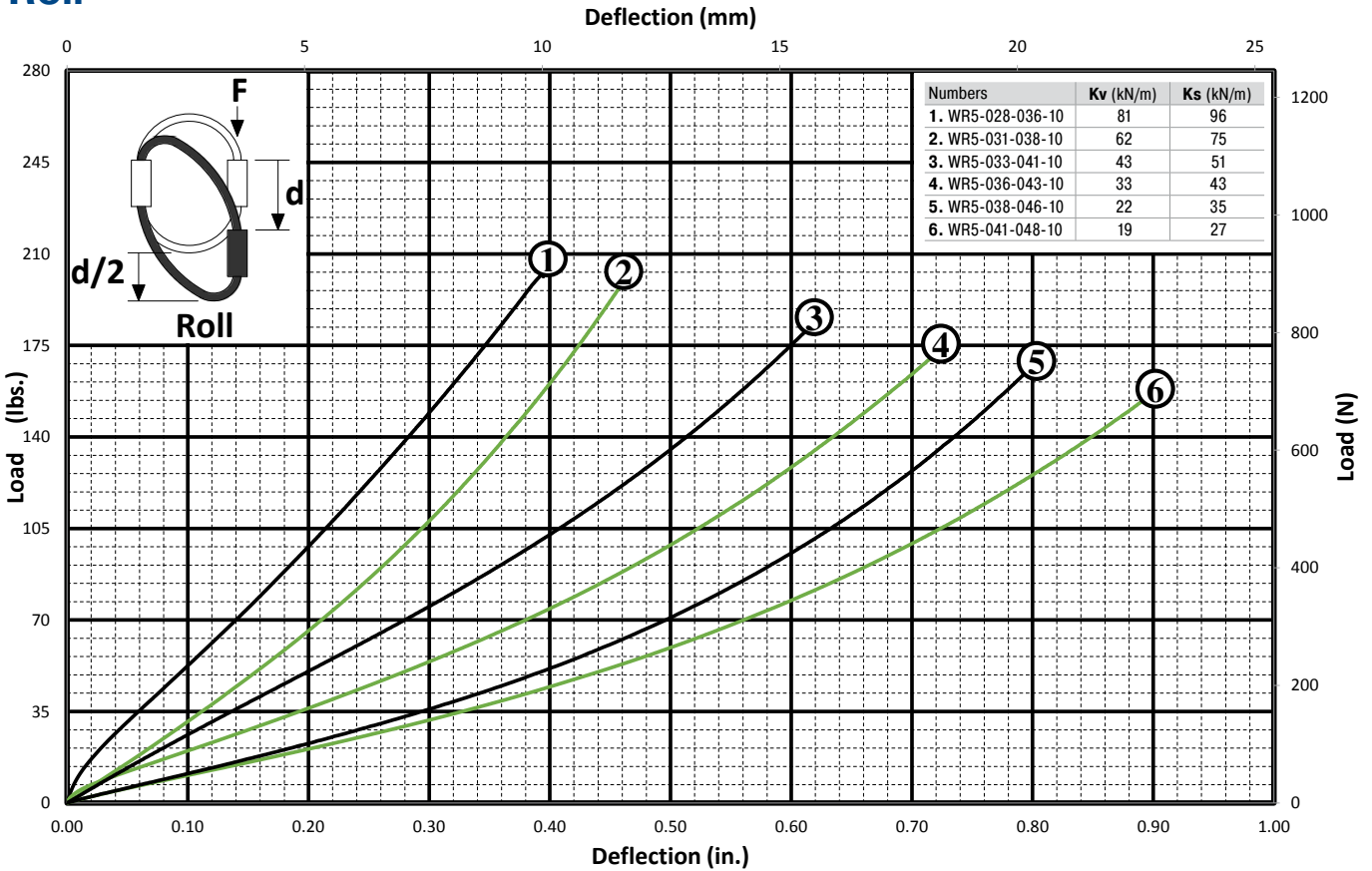

### 45° Compression/Roll

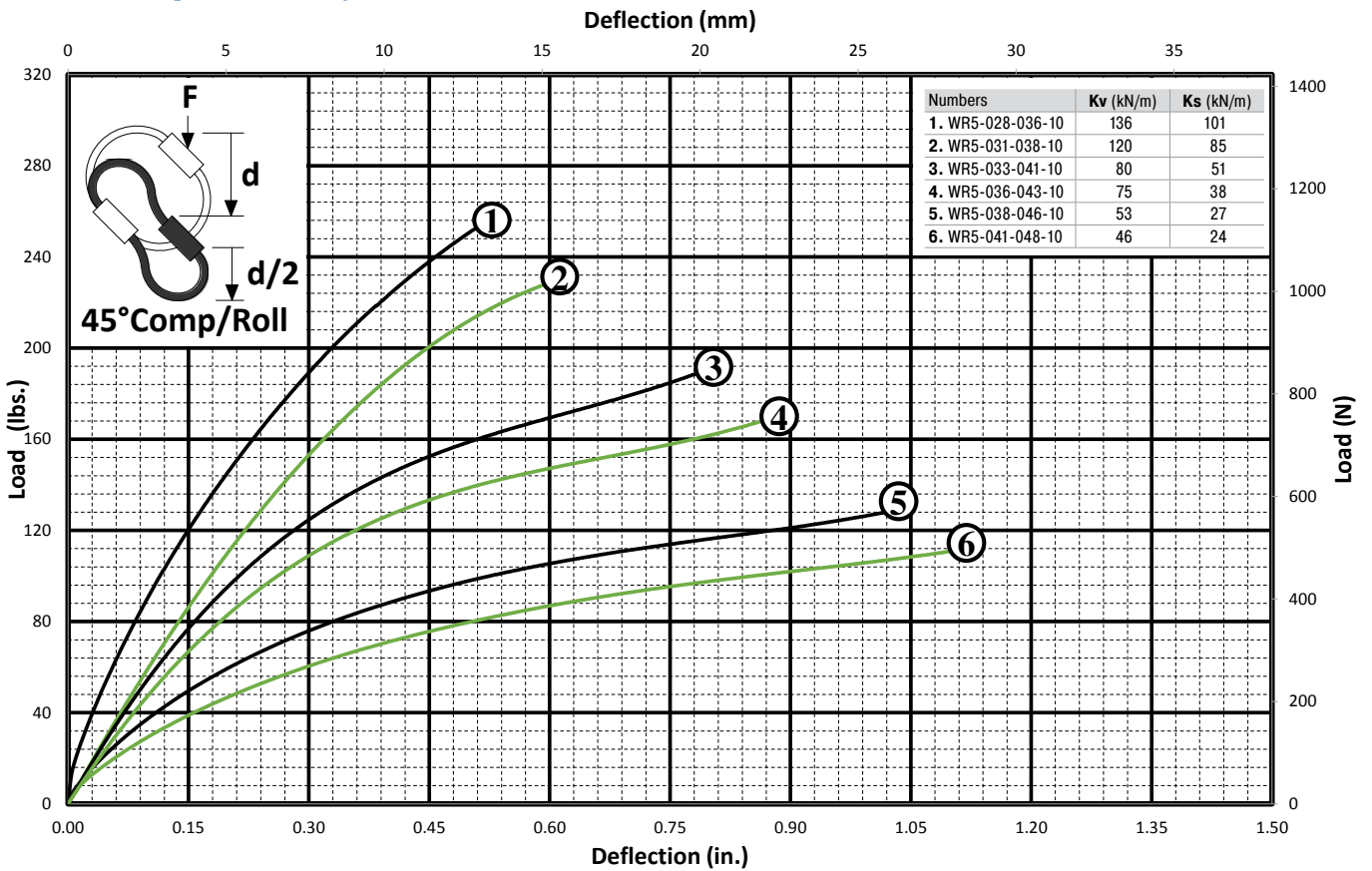

### 45° Tension/Roll

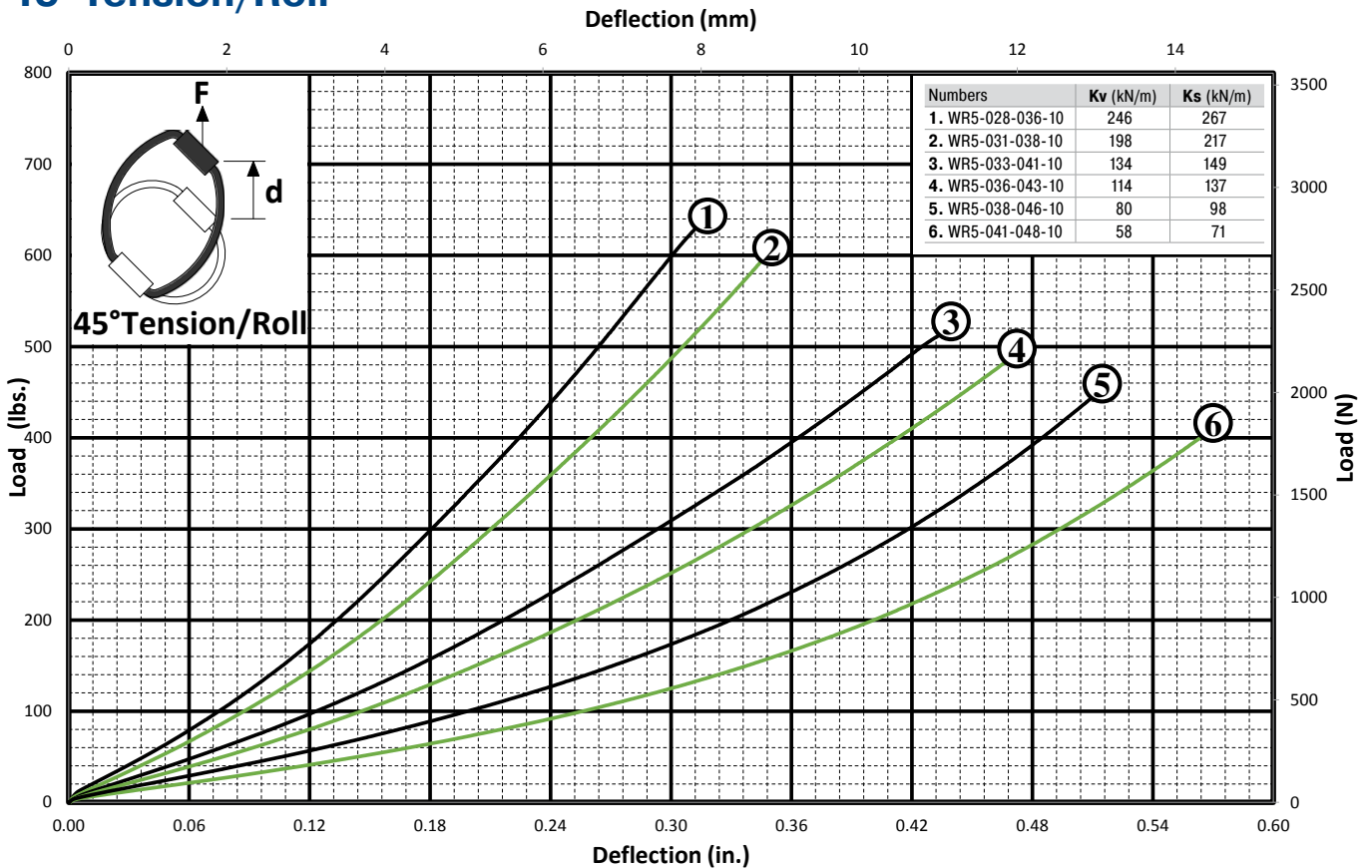

Product also available in stainless steel



# WR6A

## Helical Isolator

### 4.76 mm (3/16") Diameter Cable

#### Features

- Rugged all metal construction
- Fail safe construction
- Long life and maintenance free
- Three axis capability (6 dof)
- High damping: C/cc ≈ 0.15 to 0.20

#### Operating temperature range

-130°C to +260°C

#### Material

- Cable: 300 Series SS per MIL-W-83420 or RR-W-410
- Screws: 300 Series SS per MS51959-28
- Inserts: 300 Series SS (alum bars only)
- Retainer bars: Standard: 6061-T6 Alum alloy/ Chem film IAW MIL-DTL-5541, TYPE II, Class 3

#### Note

- Mounting hole tolerances: ±0.25 mm
- Add 0.15 kg to Isolator weight for all stainless steel versions

#### On request

Special materials, size, mounting holes, finish, etc. available

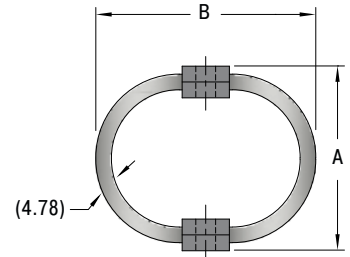
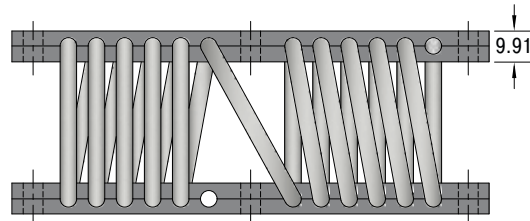
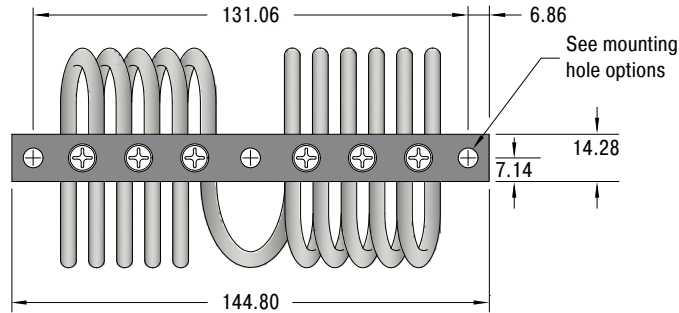

#### Performance

TYPES	A (+/- 0.8) mm	B mm	Compression			Shear/Roll (Average)			Weight kg
			Kv (Vibe) kN/m	Ks (Shock) kN/m	Deflection max. mm	Kv (Vibe) kN/m	Ks (Shock) kN/m	Deflection max. mm	
WR6A-051-058-11	50.8	57.9	81	58	25.4	27	29	25.4	0.244
WR6A-052-064-11	52.3	63.5	66	48	26.7	18	25	26.7	0.253
WR6A-054-075-11	54.1	74.7	45	32	27.9	13	18	27.9	0.267
WR6A-056-081-11	55.6	81.0	32	23	29.2	11	15	29.2	0.289
WR6A-062-088-11	62.2	87.6	29	19	40.6	6.7	11	40.6	0.301
WR6A-081-107-11	81.3	106.7	15	8.6	55.9	3.2	6.0	55.9	0.363

#### Ordering Example

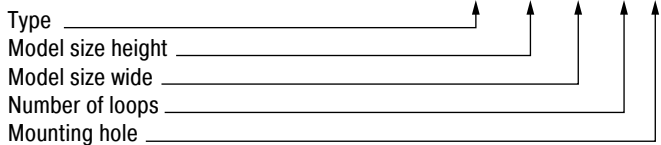

#### Mounting Hole Options

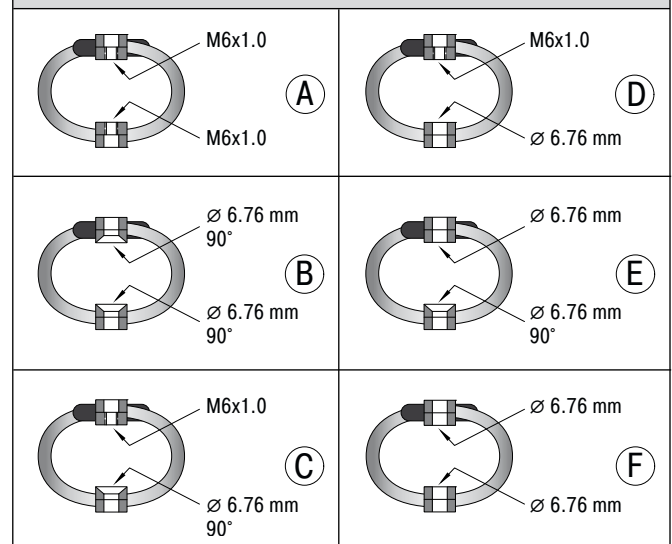

Issue 07.2020 – Specifications subject to change

### Compression

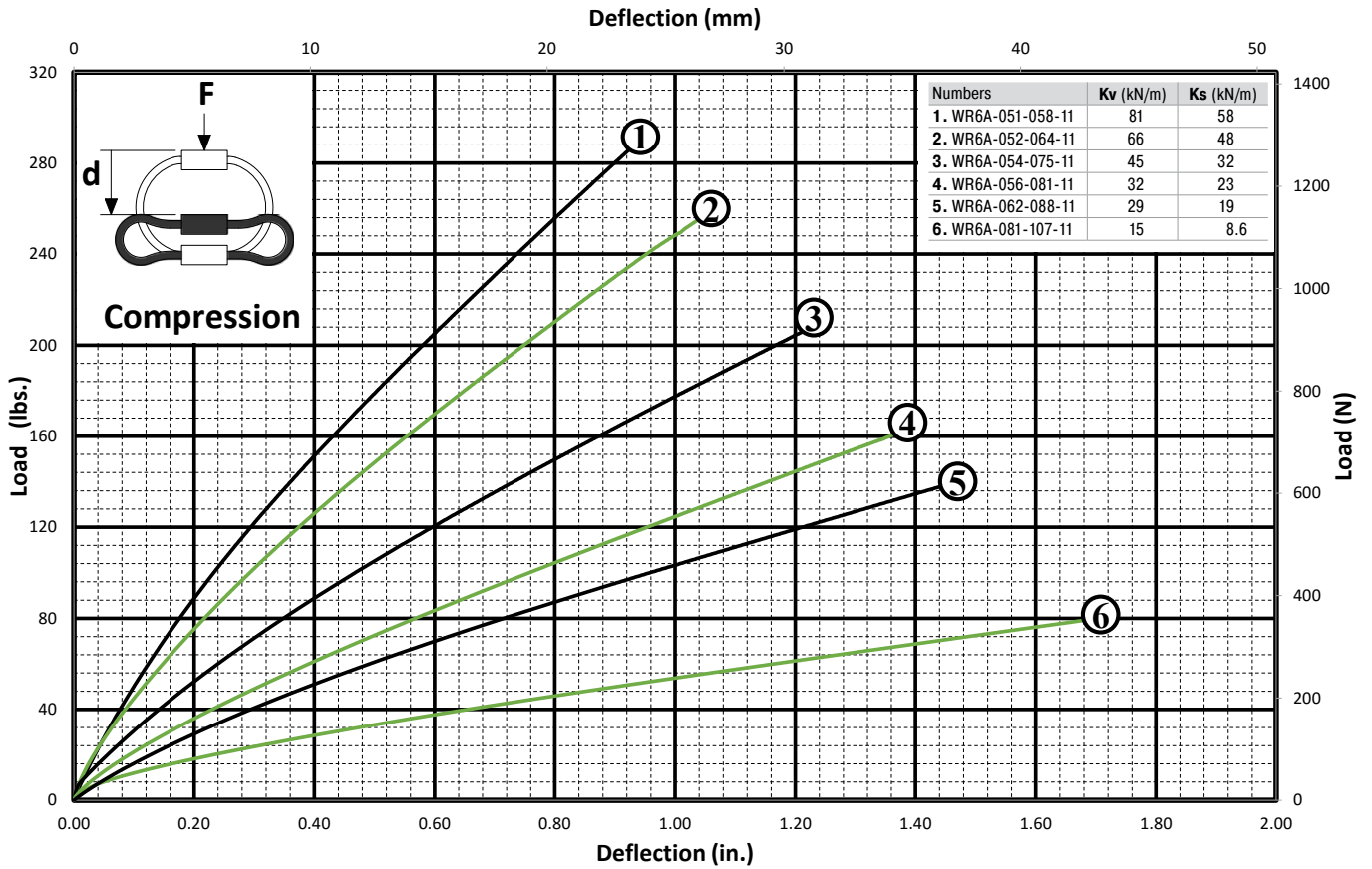

### Tension

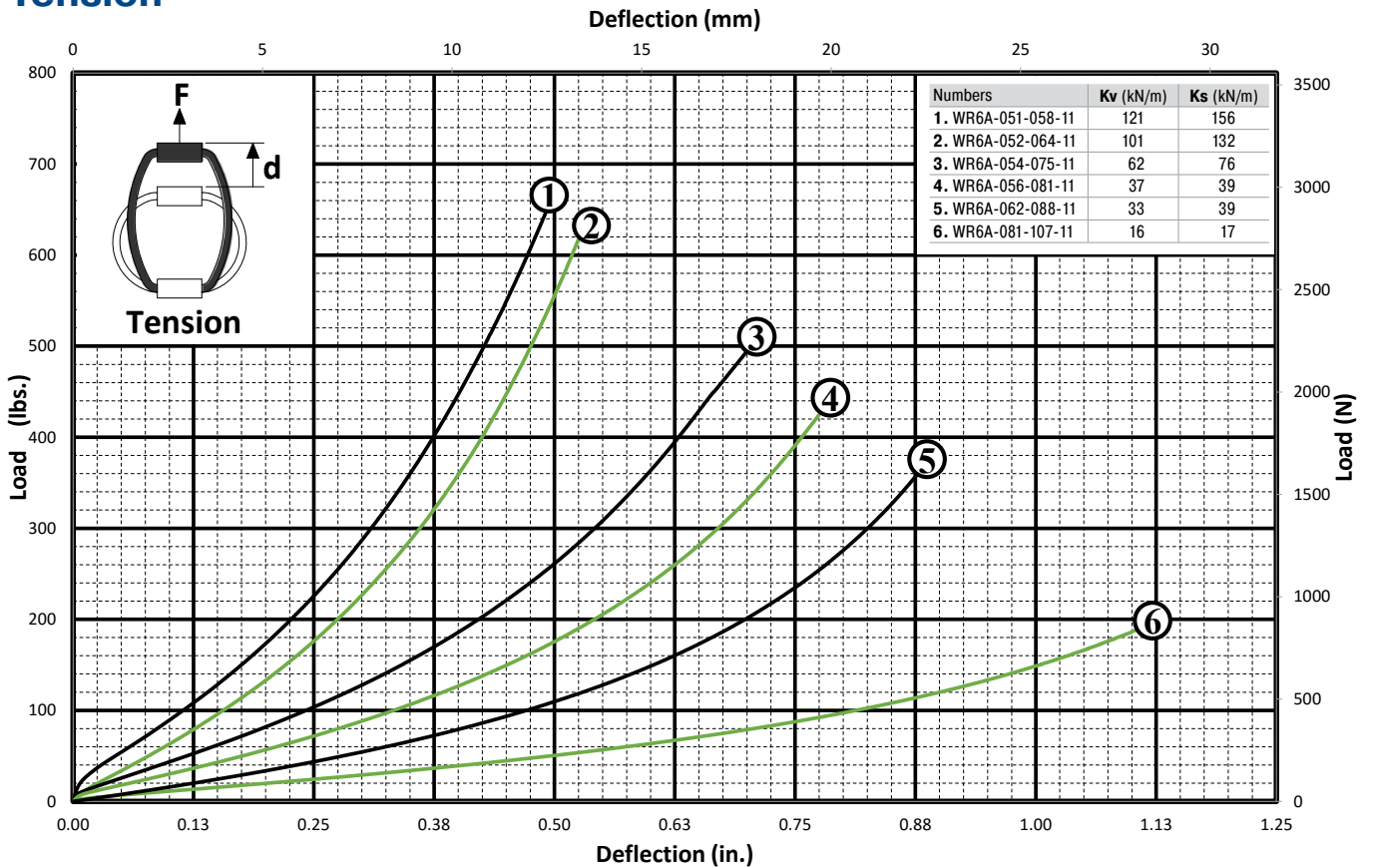

Issue 07.2020 – Specifications subject to change



### Shear

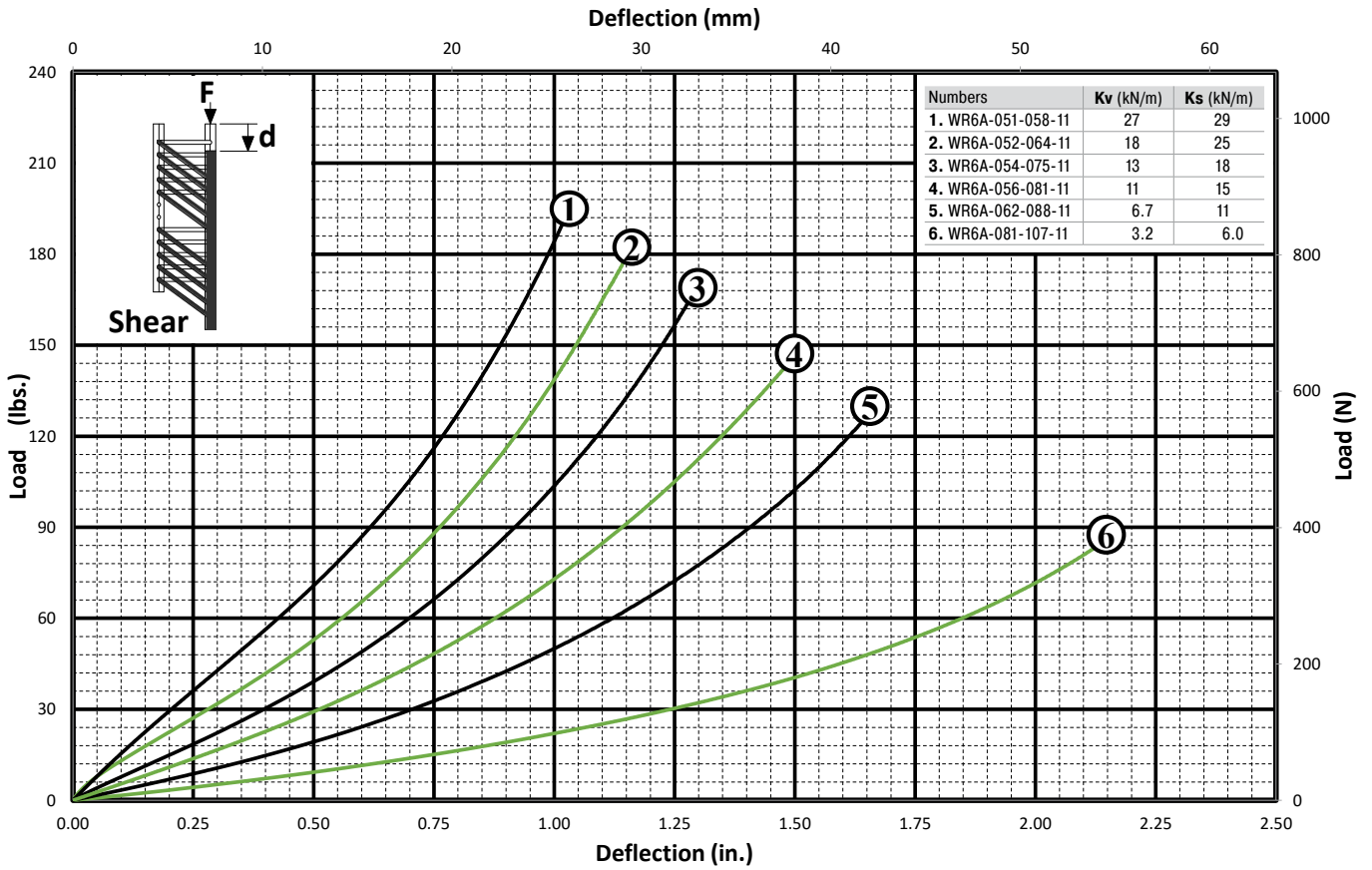

### Roll

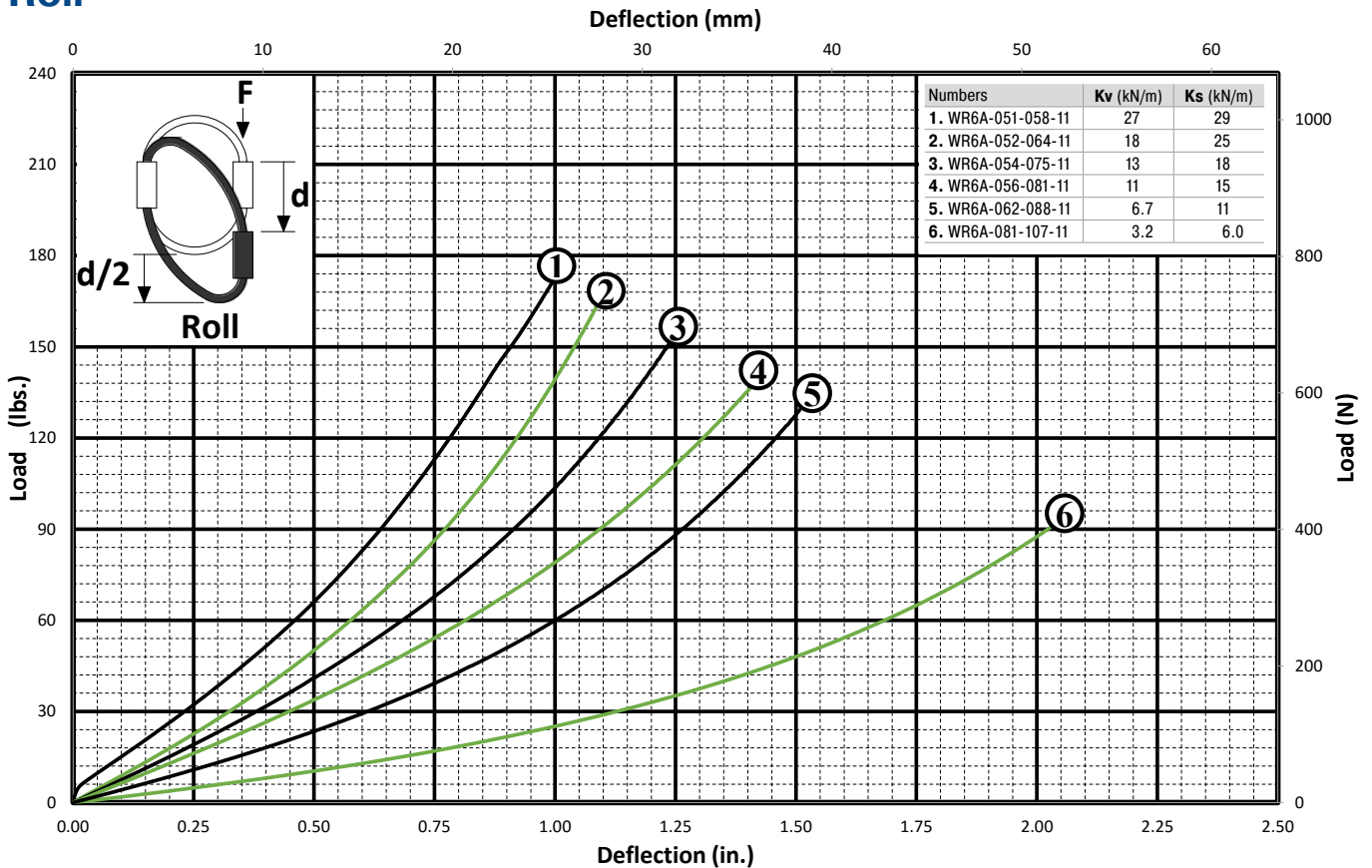

### 45° Compression/Roll

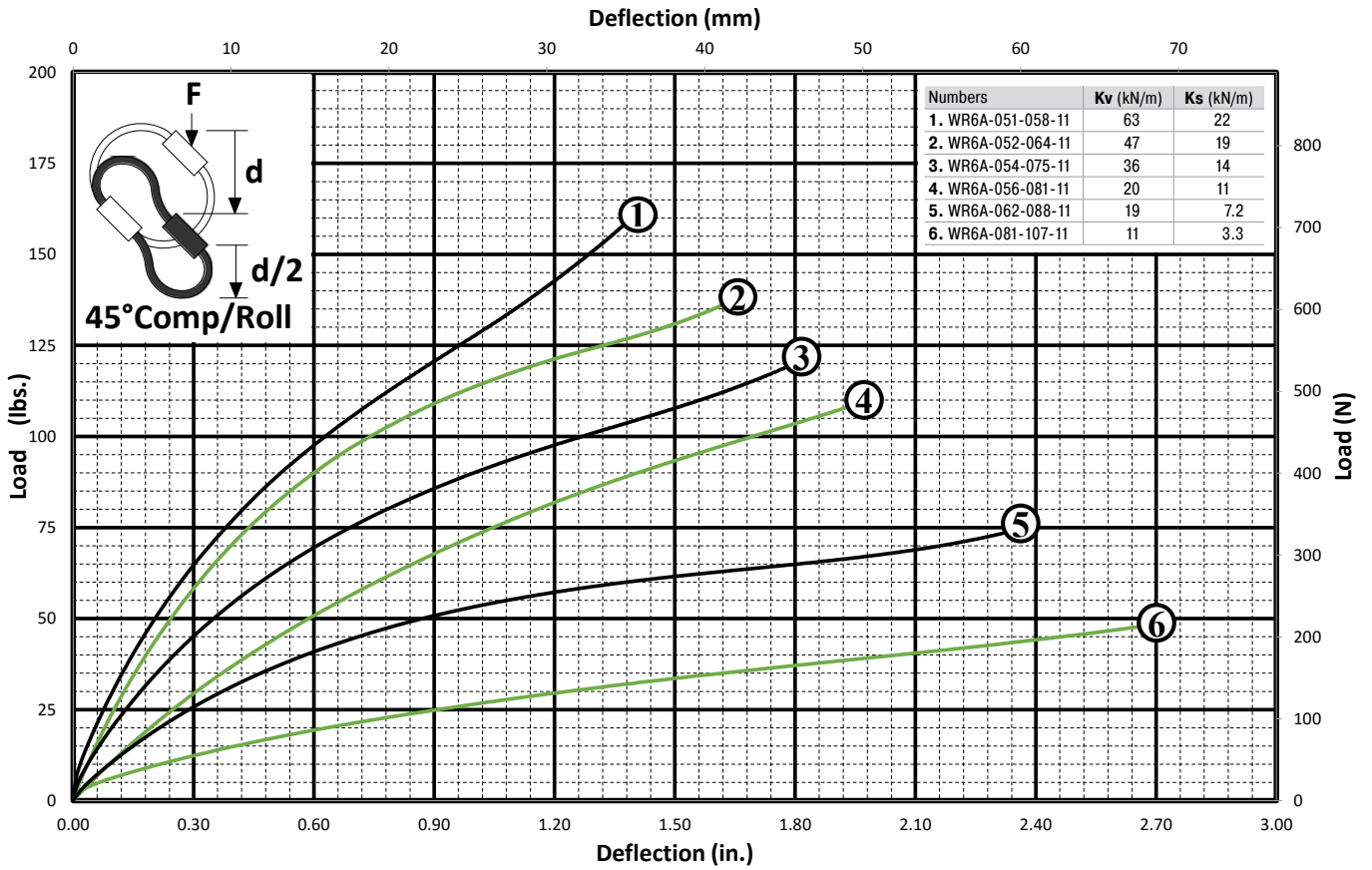

### 45° Tension/Roll

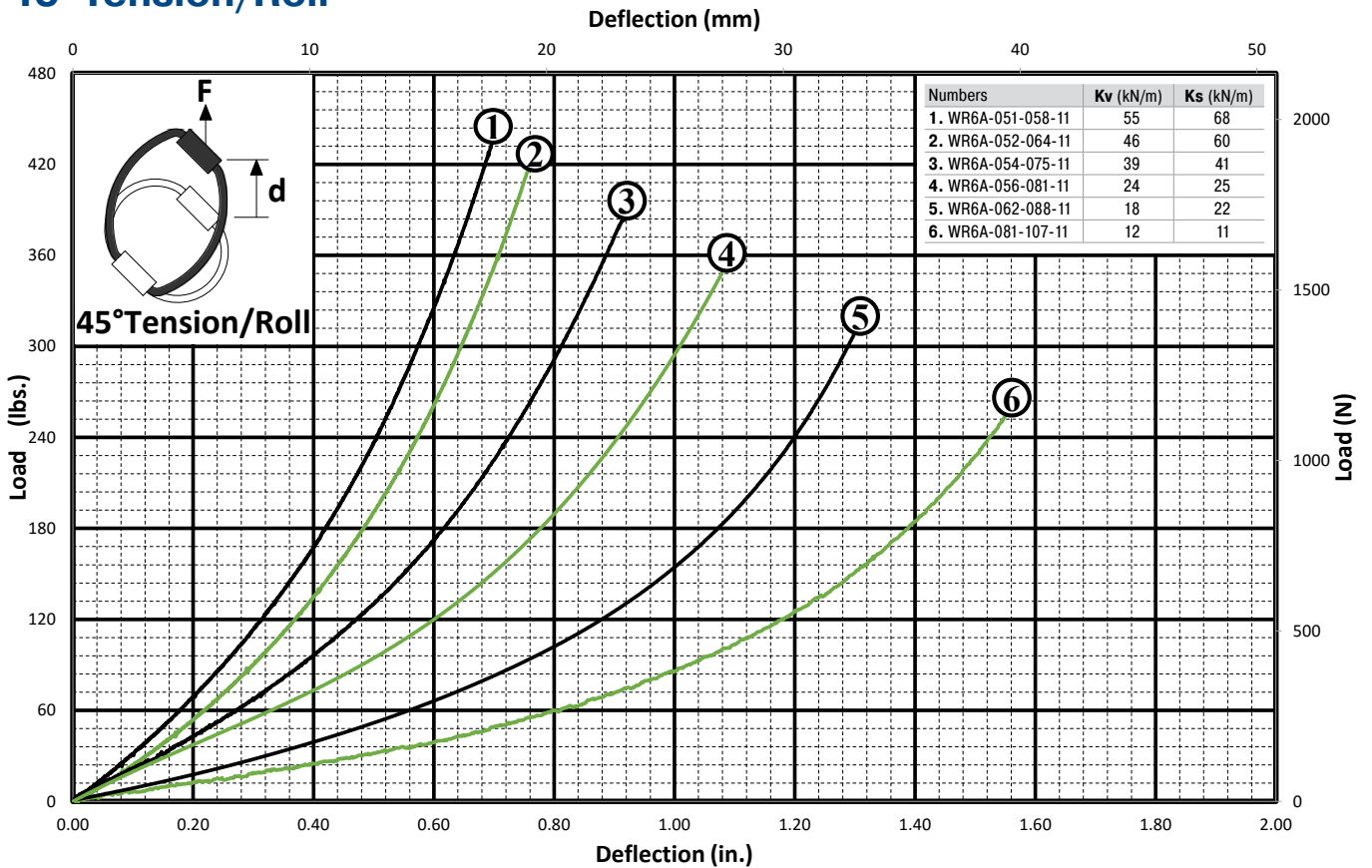



Product also available in stainless steel



# WR6

## Helical Isolator

### 4.76 mm (3/16") Diameter Cable



#### Features

- Rugged all metal construction
- Fail safe construction
- Long life and maintenance free
- Three axis capability (6 dof)
- High damping: C/cc ≈ 0.15 to 0.20

#### Operating temperature range

-130°C to +260°C

#### Material

- Cable: 300 Series SS per MIL-W-83420 or RR-W-410
- Screws: 300 Series SS per MS51959-28
- Inserts: 300 Series SS (alum bars only)
- Retainer bars: Standard: 6061-T6 Alum alloy/ Chem film IAW MIL-DTL-5541, TYPE II, Class 3

#### Note

- Mounting hole tolerances: ±0.25 mm
- Add 0.12 kg to Isolator weight for all stainless steel versions

#### On request

Special materials, size, mounting holes, finish, etc. available

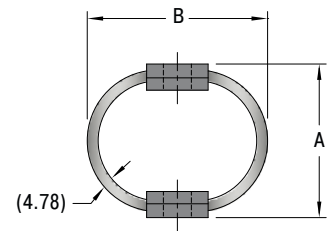
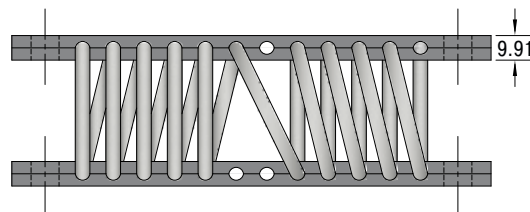
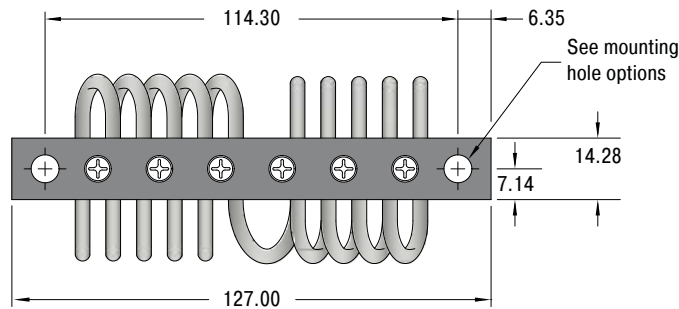

#### Performance

TYPES	A (+/- 0.8) mm	B mm	Compression			Shear/Roll (Average)			Weight kg
			Kv (Vibe) kN/m	Ks (Shock) kN/m	Deflection max. mm	Kv (Vibe) kN/m	Ks (Shock) kN/m	Deflection max. mm	
WR6-031-036-10	30.5	35.6	336	319	10.2	110	138	10.2	0.167
WR6-033-038-10	33.0	38.1	278	248	11.4	100	123	11.4	0.170
WR6-036-041-10	35.6	40.6	251	223	12.7	73	90	12.7	0.176
WR6-038-043-10	38.1	43.2	219	187	15.2	63	82	15.2	0.182
WR6-041-046-10	40.6	45.7	168	138	17.8	51	65	17.8	0.187
WR6-043-048-10	43.2	48.2	129	103	20.3	39	54	20.3	0.193
WR6-048-053-10	48.2	53.3	89	67	25.4	28	35	25.4	0.210
WR6-051-058-10	51.0	58.4	75	57	27.9	21	30	27.9	0.221

#### Ordering Example

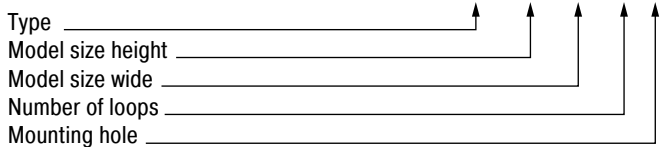

#### Mounting Hole Options

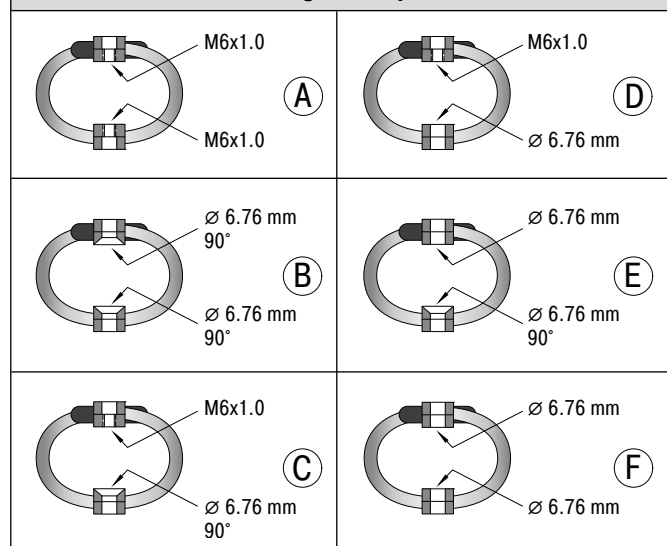

Issue 07.2020 – Specifications subject to change

## Compression

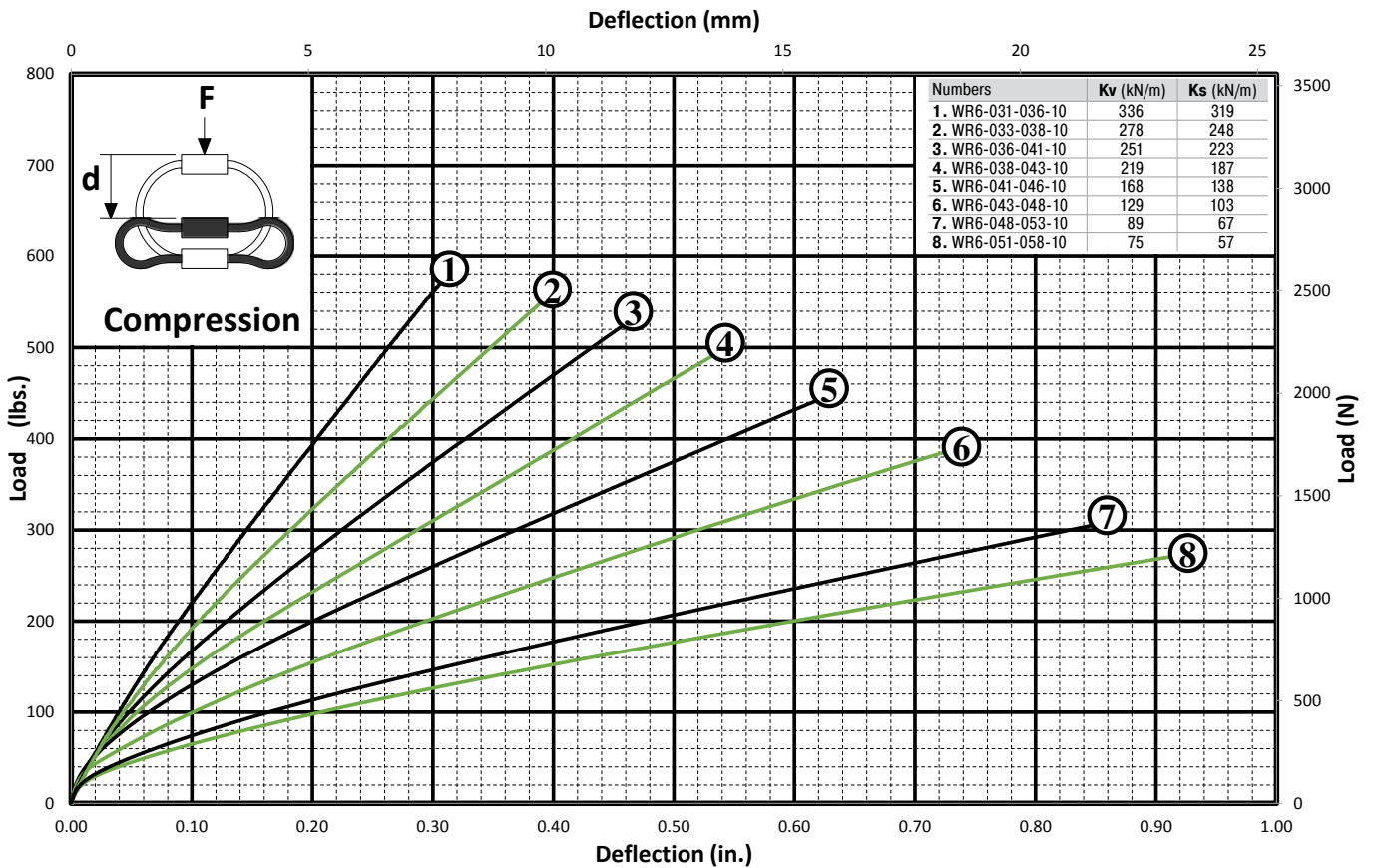

## Tension

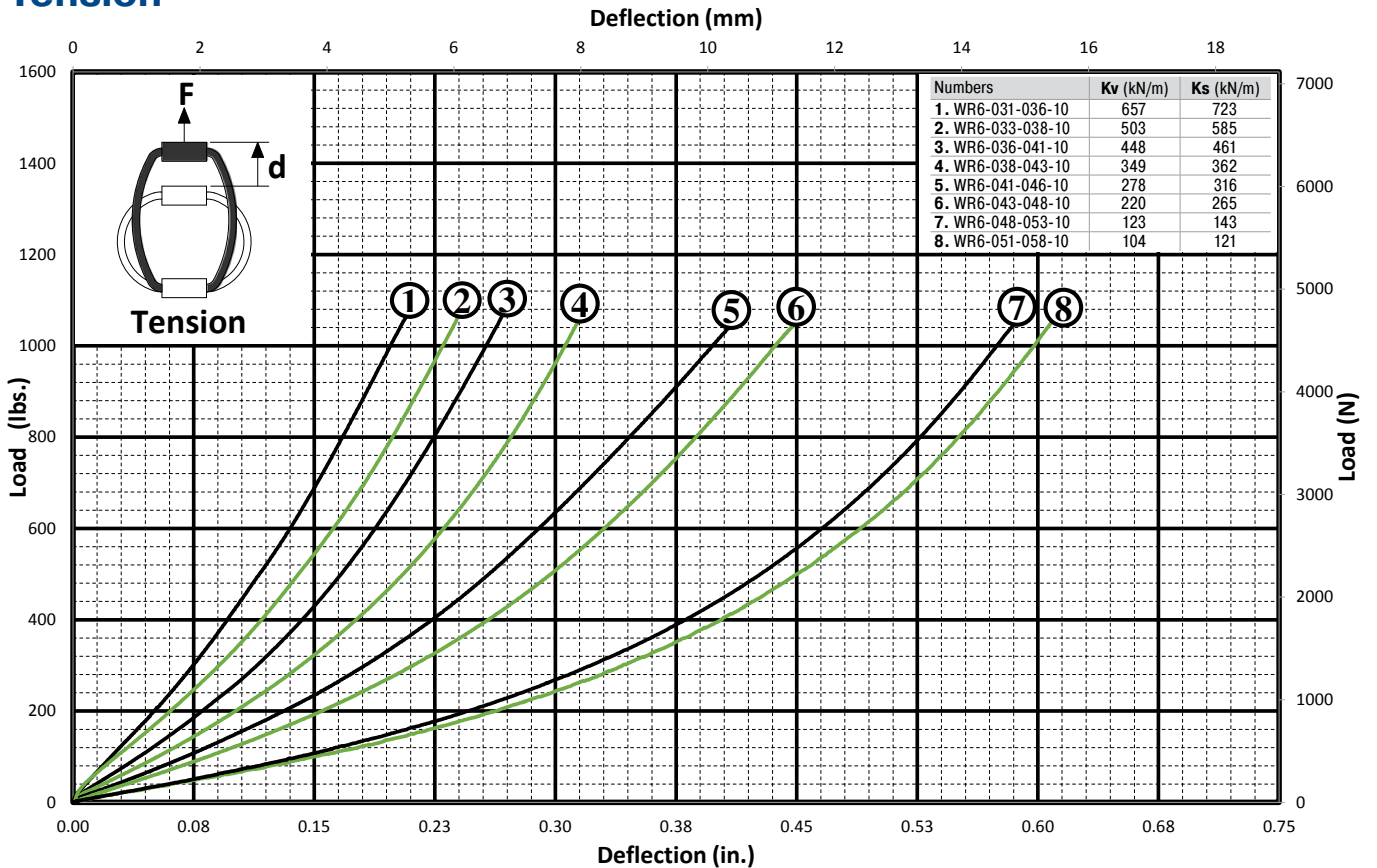

Issue 07.2020 – Specifications subject to change

Helical Isolator, 4.76 mm (3/16") Diameter Cable

### Shear

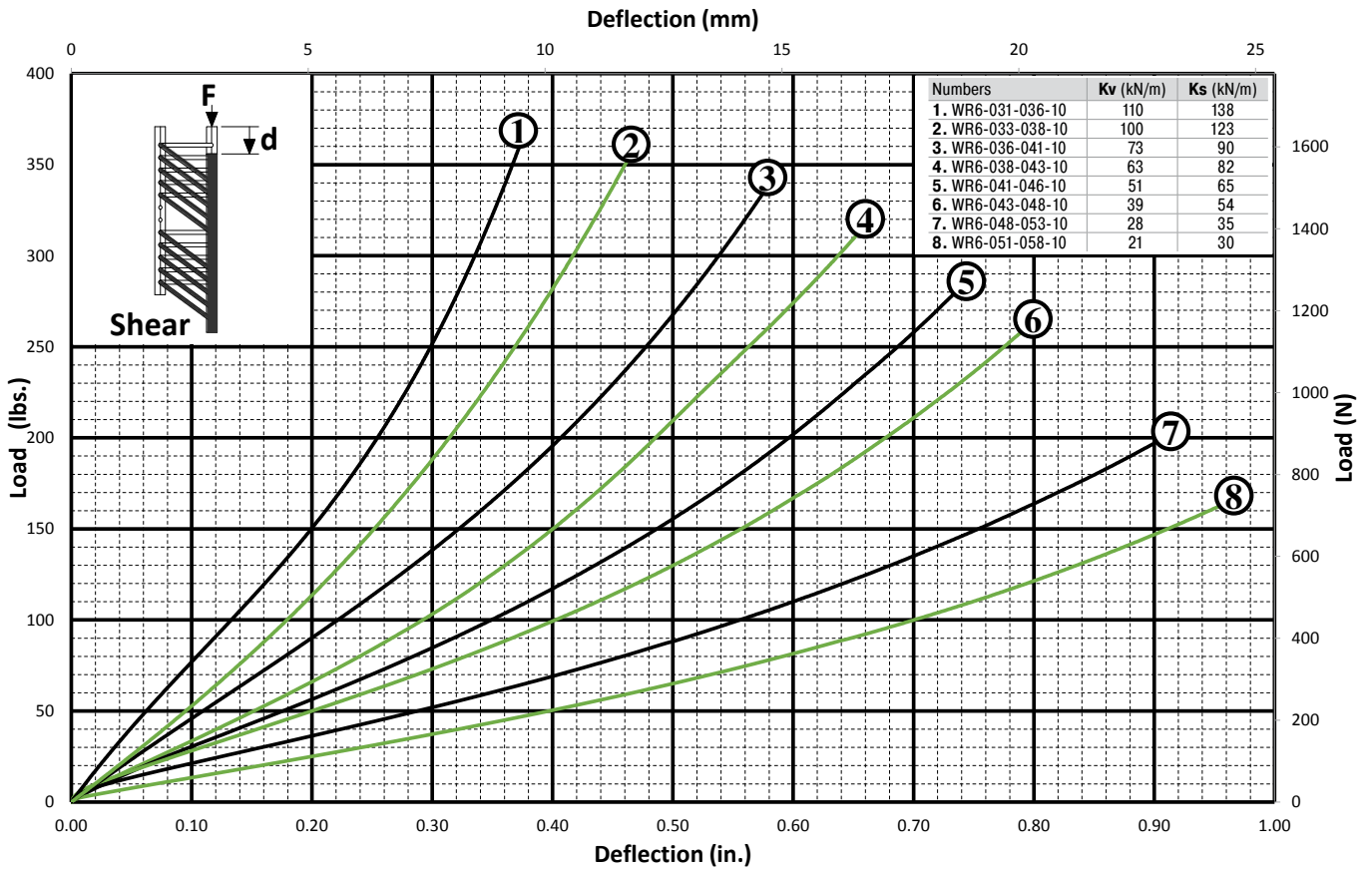

### Roll

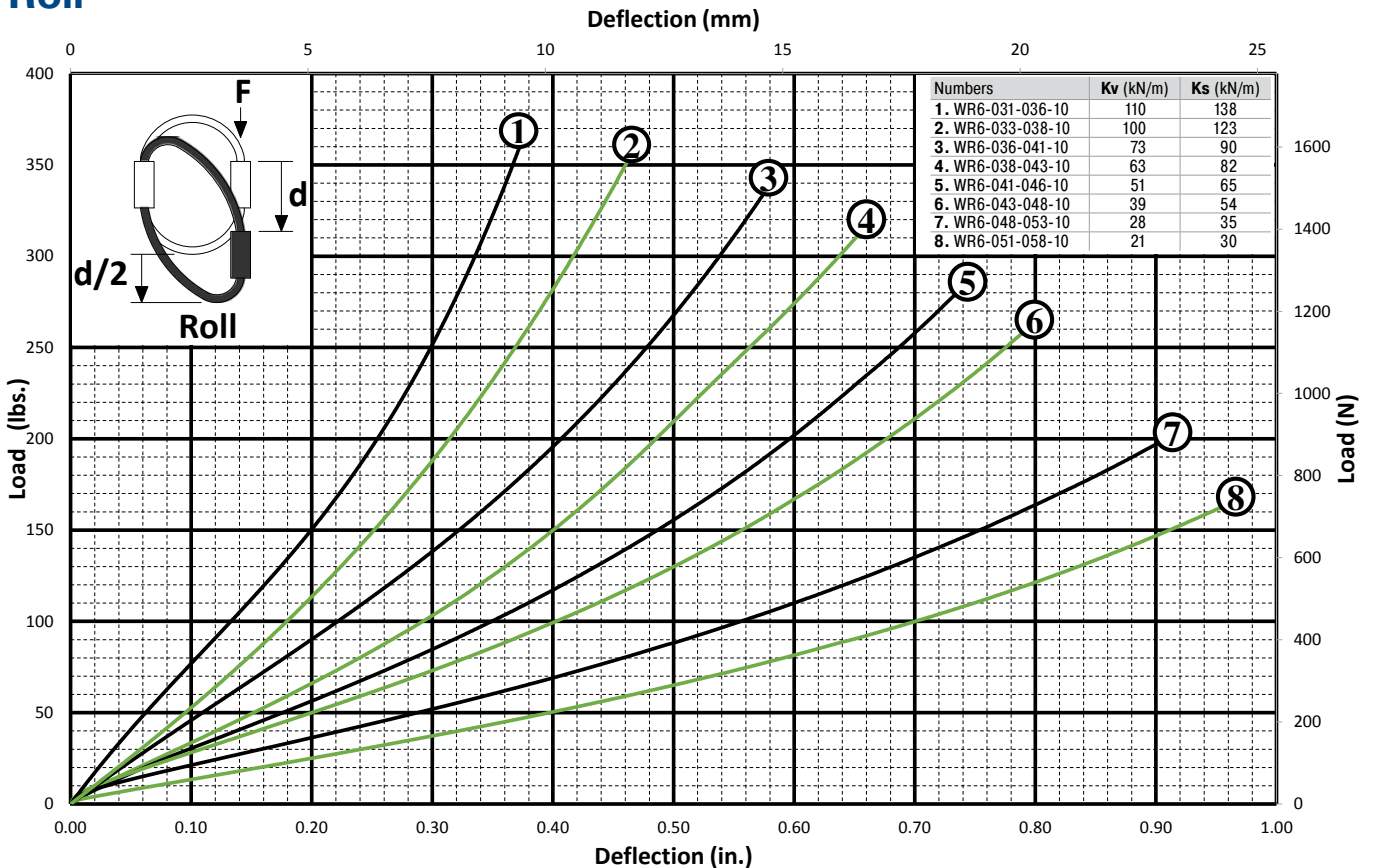

## 45° Compression/Roll

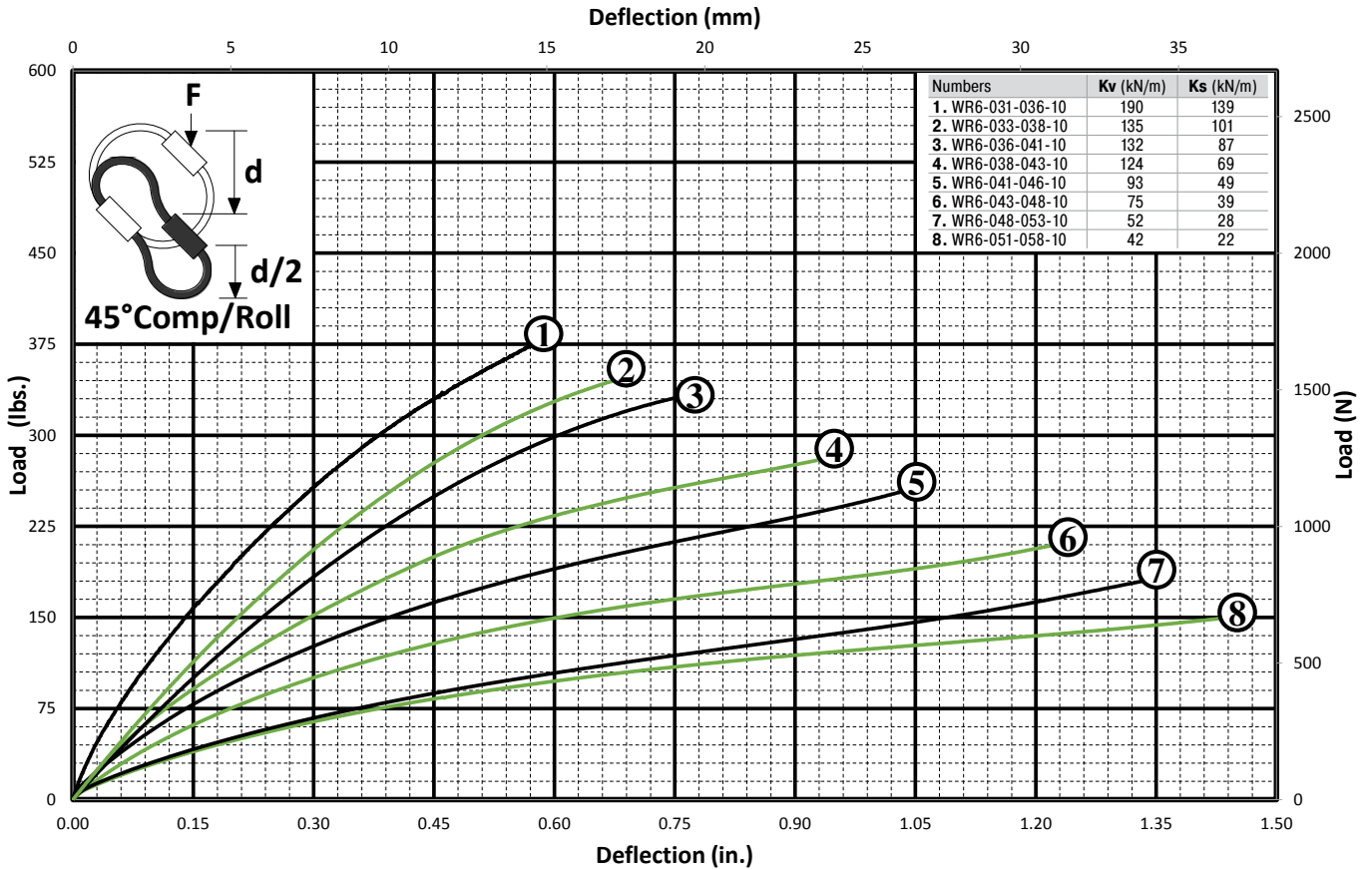

## 45° Tension/Roll

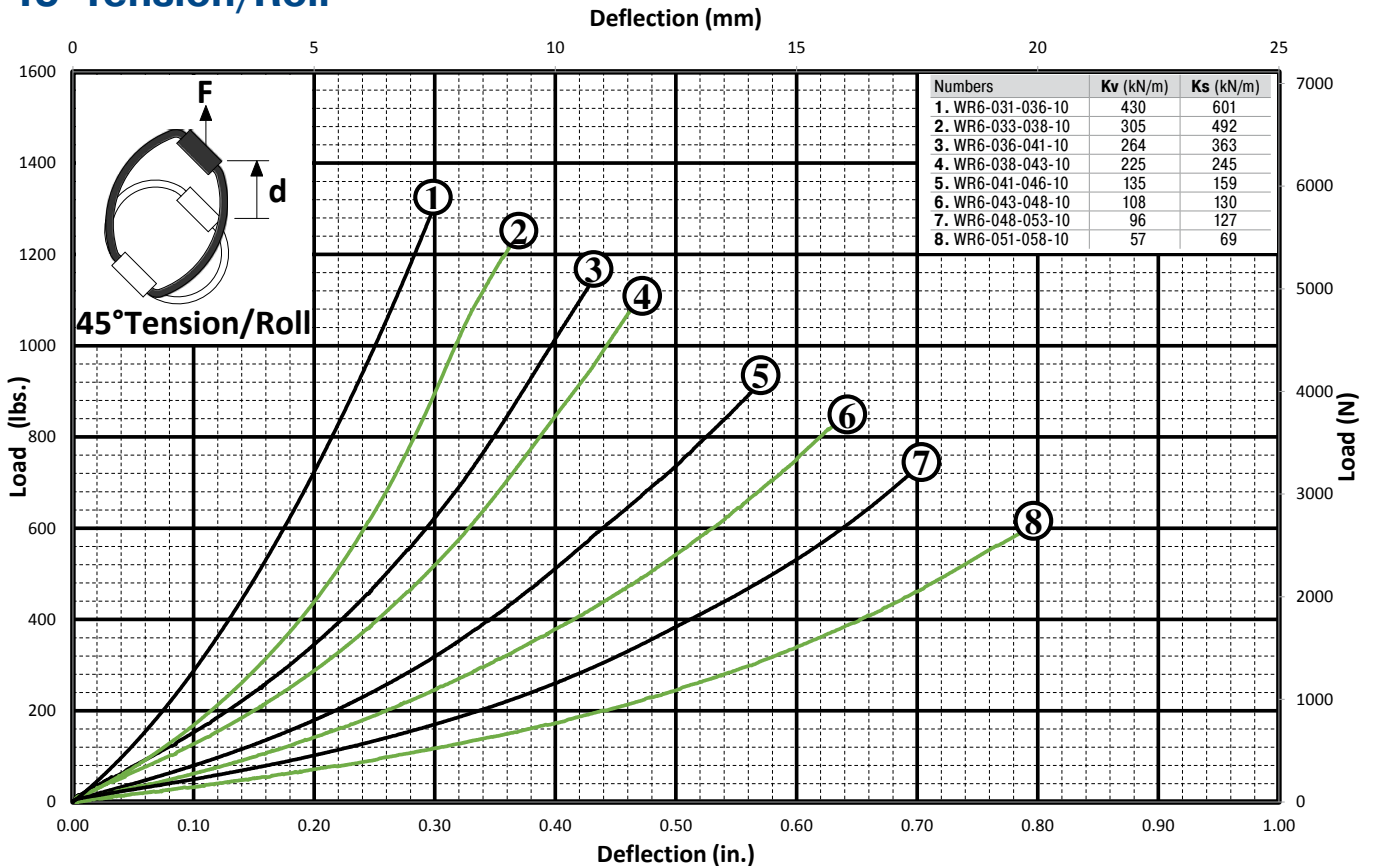

Product also available in stainless steel



# WR8

## Helical Isolator

### 6.35 mm (1/4") Diameter Cable



#### Features

- Rugged all metal construction
- Fail safe construction
- Long life and maintenance free
- Three axis capability (6 dof)
- High damping: C/cc ≈ 0.15 to 0.20

#### Operating temperature range

-130°C to +260°C

#### Material

- Cable: 300 Series SS per MIL-W-83420 or RR-W-410
- Screws: 300 Series SS passivated IAW ASTM A967
- Inserts: 300 Series SS (alum bars only)
- Retainer bars: Standard: 6061-T6 Alum alloy/ Chem film IAW MIL-DTL-5541, TYPE II, Class 3

#### Note

- Mounting hole tolerances: ±0.25 mm
- Add 0.20 kg to Isolator weight for all stainless steel versions

#### On request

Special materials, size, mounting holes, finish, etc. available

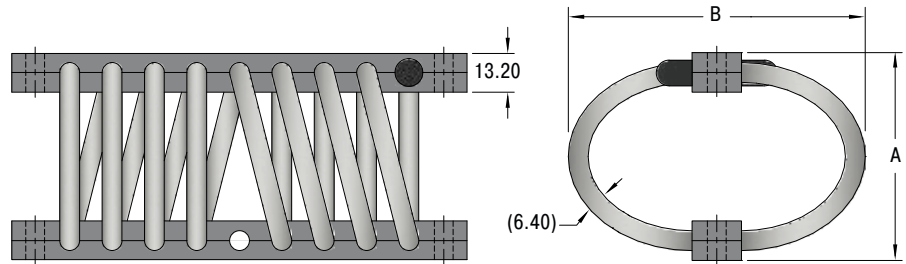
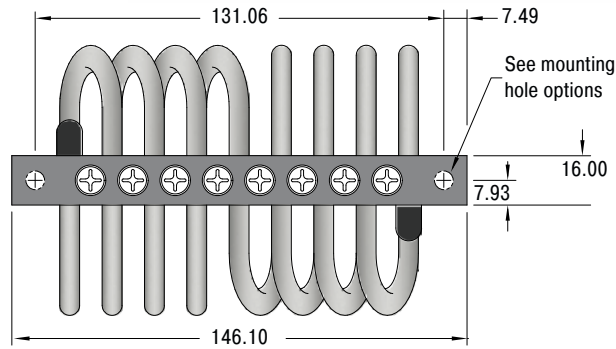

#### Performance

TYPES	A (+/- 0.8) mm	B mm	Compression			Shear/Roll (Average)			Weight kg
			Kv (Vibe) kN/m	Ks (Shock) kN/m	Deflection max. mm	Kv (Vibe) kN/m	Ks (Shock) kN/m	Deflection max. mm	
WR8-048-056-8	48.4	55.9	222	168	17.8	69	76	17.8	0.318
WR8-054-064-8	54.1	63.5	163	121	22.9	67	55	22.9	0.346
WR8-059-071-8	58.7	71.1	116	78	27.9	42	39	27.9	0.358
WR8-062-080-8	62.2	79.5	77	53	31.8	31	28	31.8	0.389
WR8-065-089-8	64.8	88.9	51	37	34.3	22	19	34.3	0.426
WR8-066-095-8	66.0	95.3	50	36	35.6	18	18	35.6	0.443
WR8-069-100-8	68.6	100.3	37	25	38.1	15	14	38.1	0.454
WR8-083-108-8	82.6	108.0	27	17	52.1	9.3	9.3	52.1	0.494

#### Ordering Example

WR8-048-056-8-A

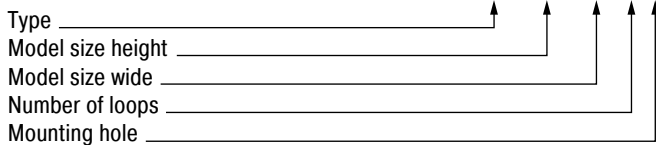

#### Mounting Hole Options

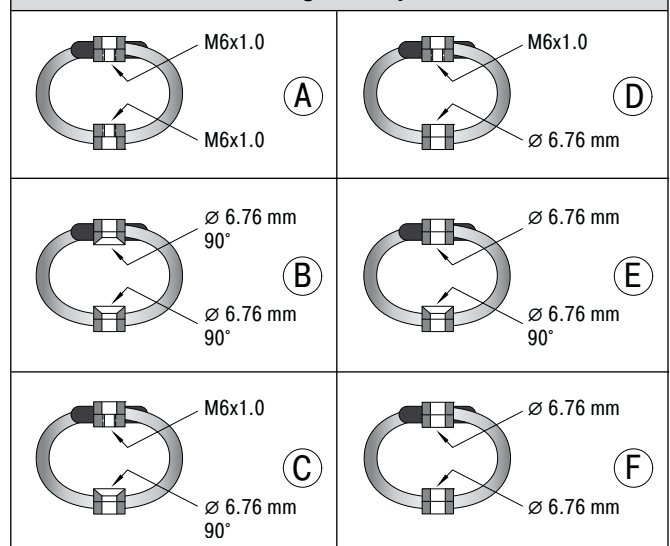

Issue 07.2020 – Specifications subject to change



## Compression

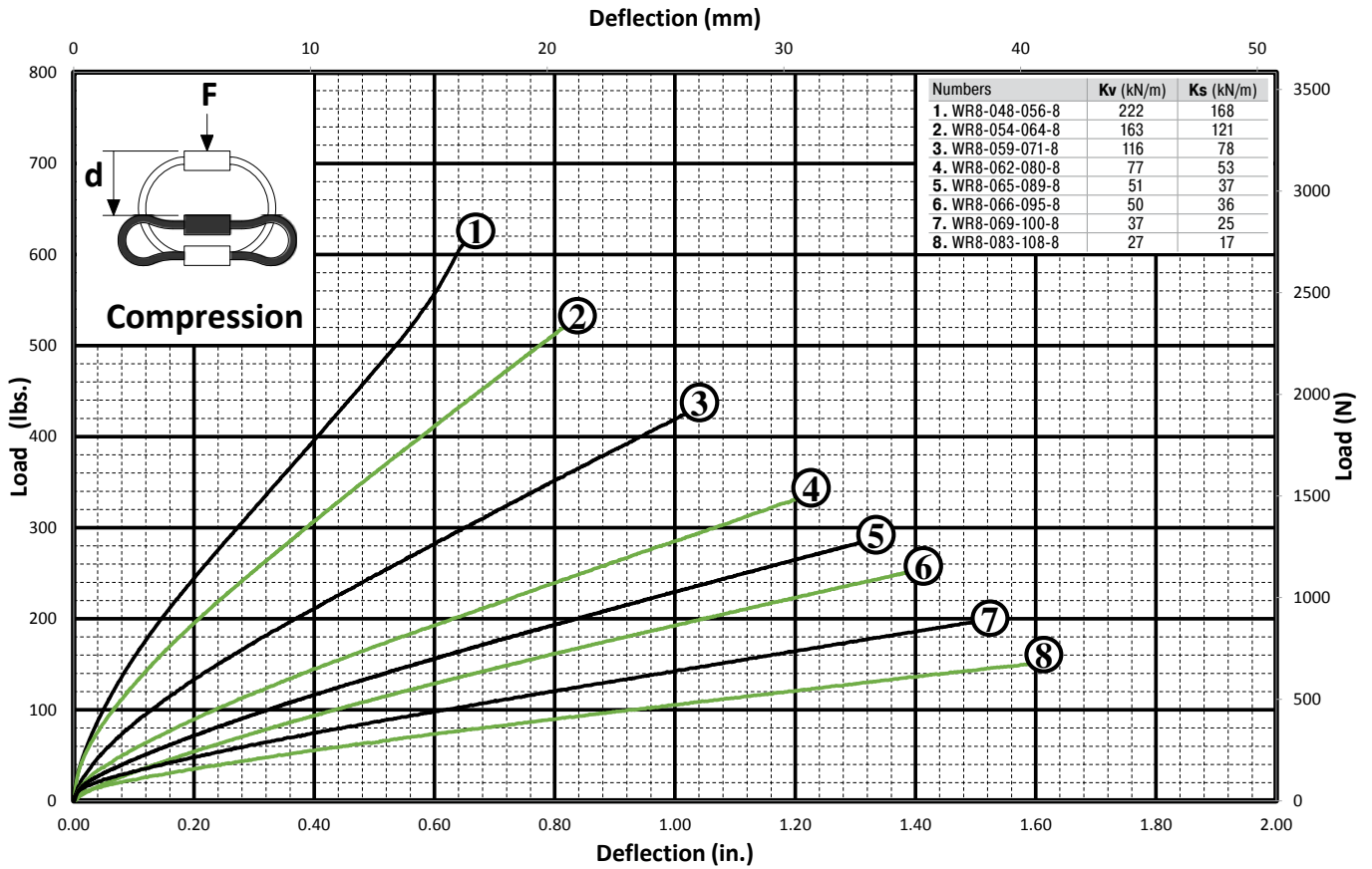

## Tension

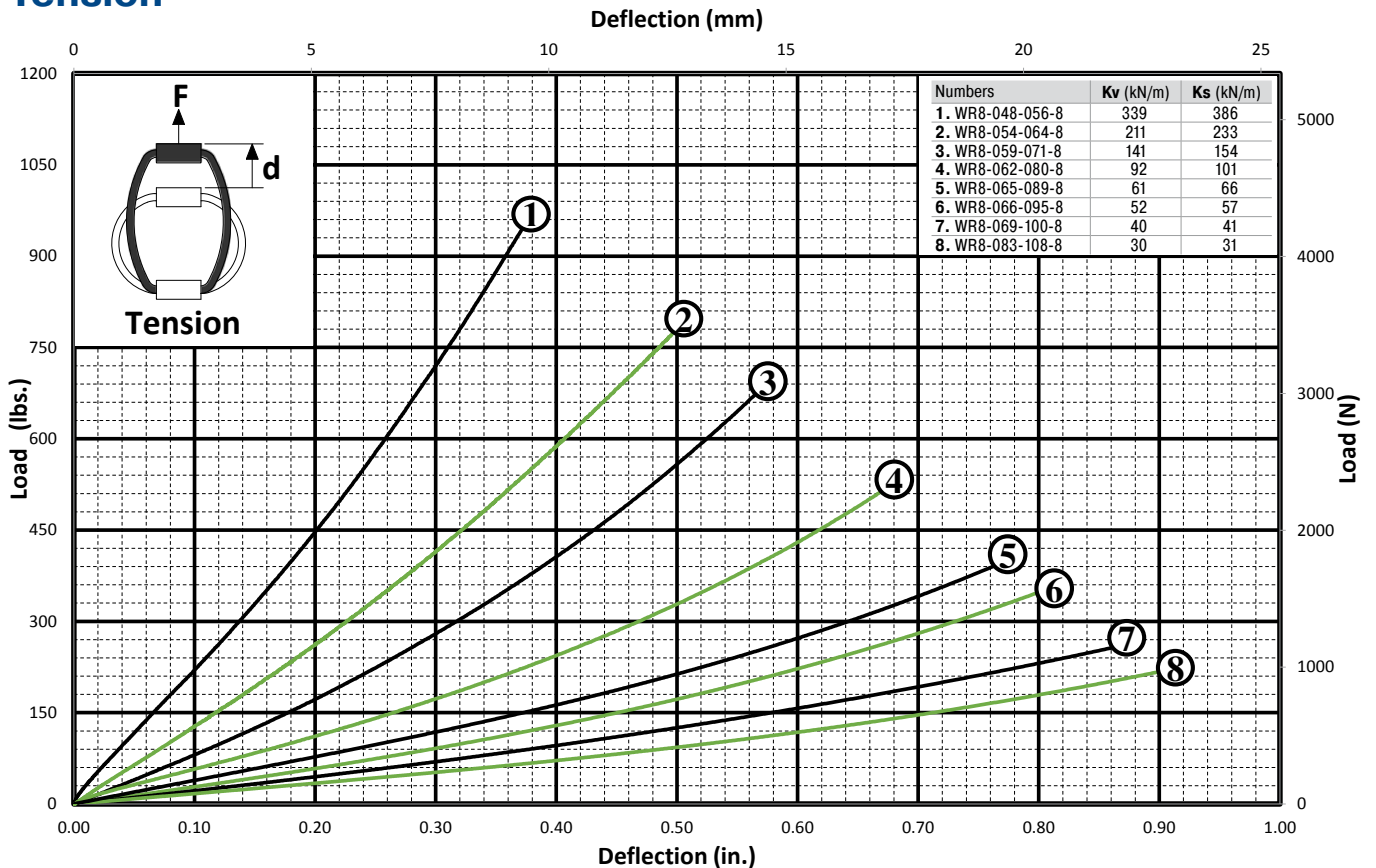

### Shear

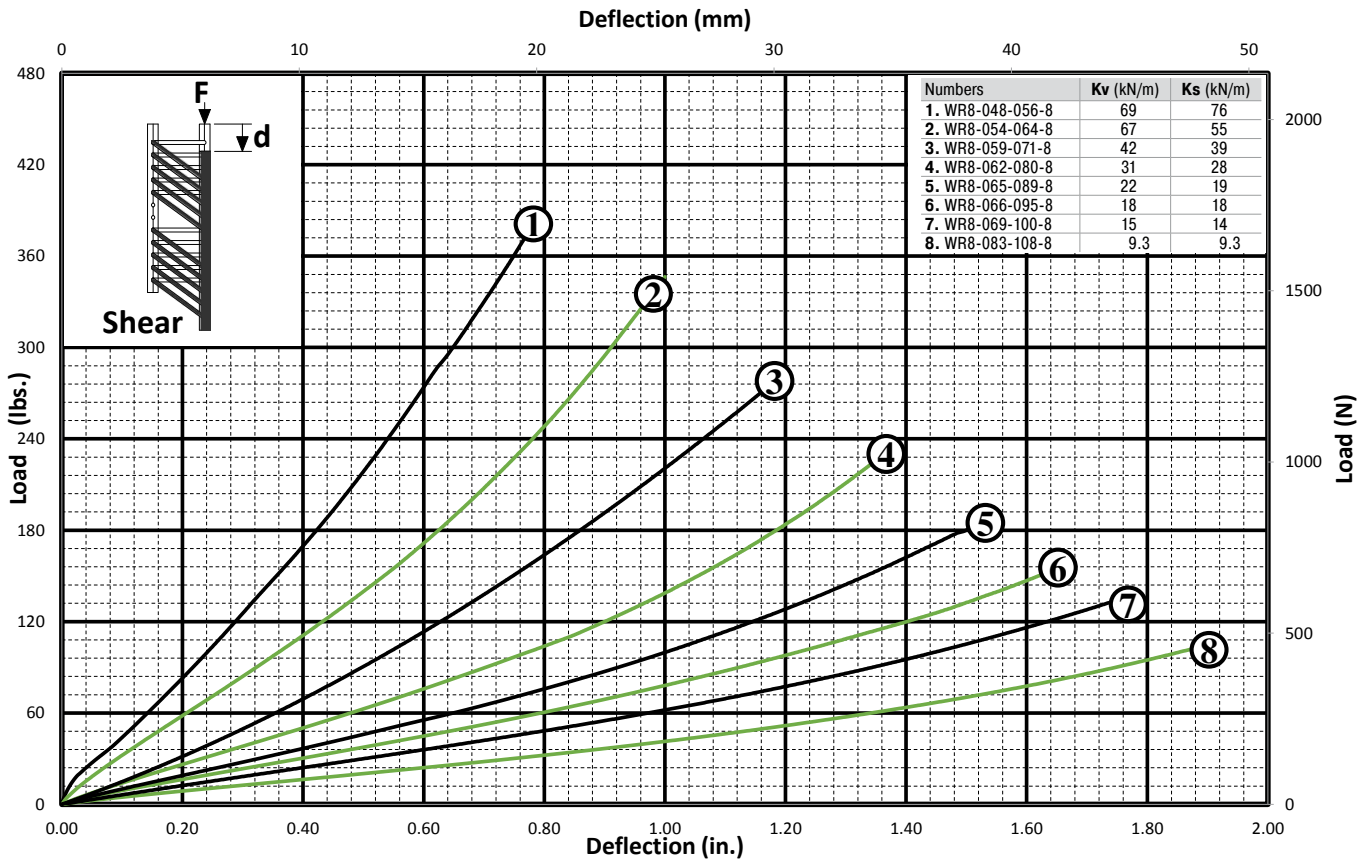

### Roll

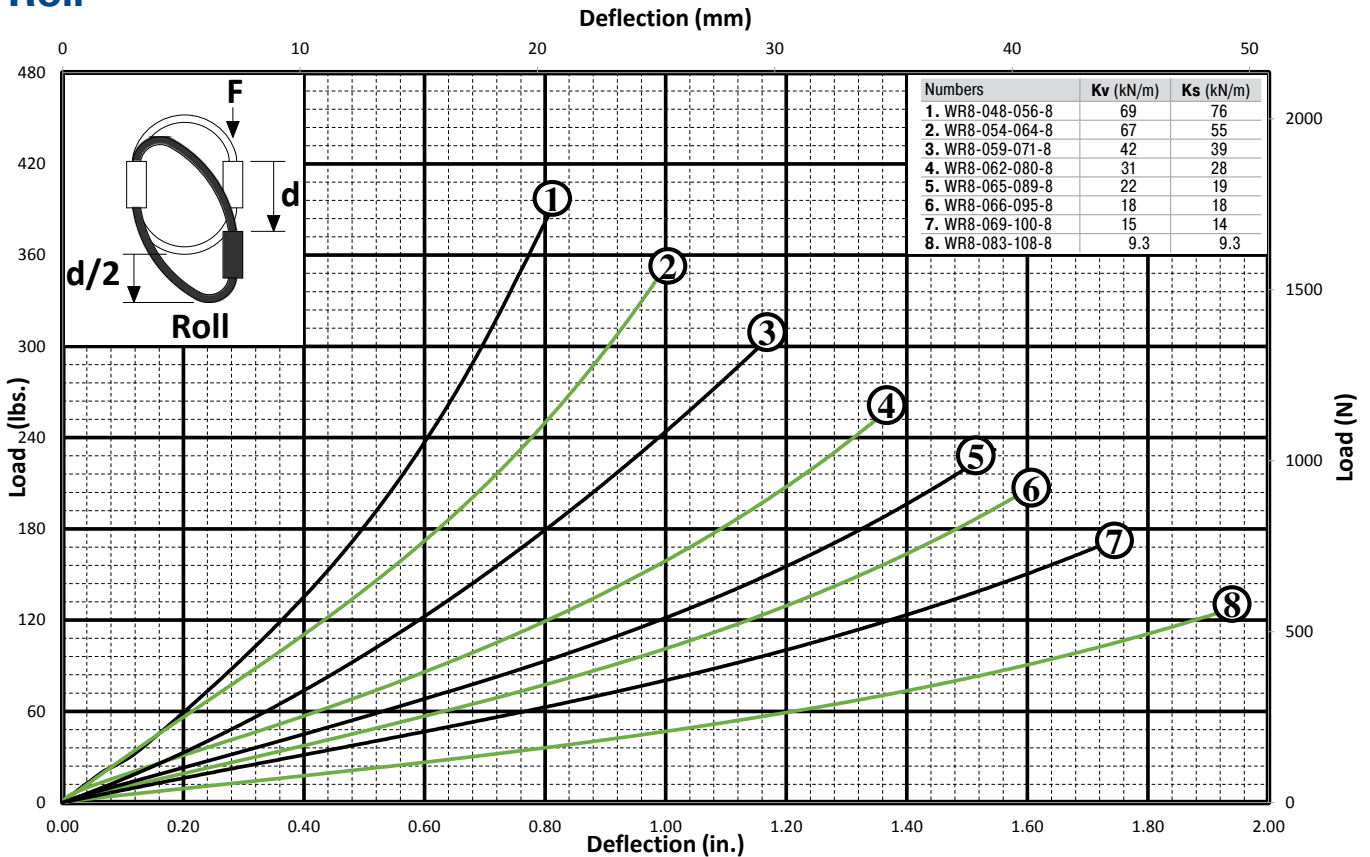



### 45° Compression/Roll

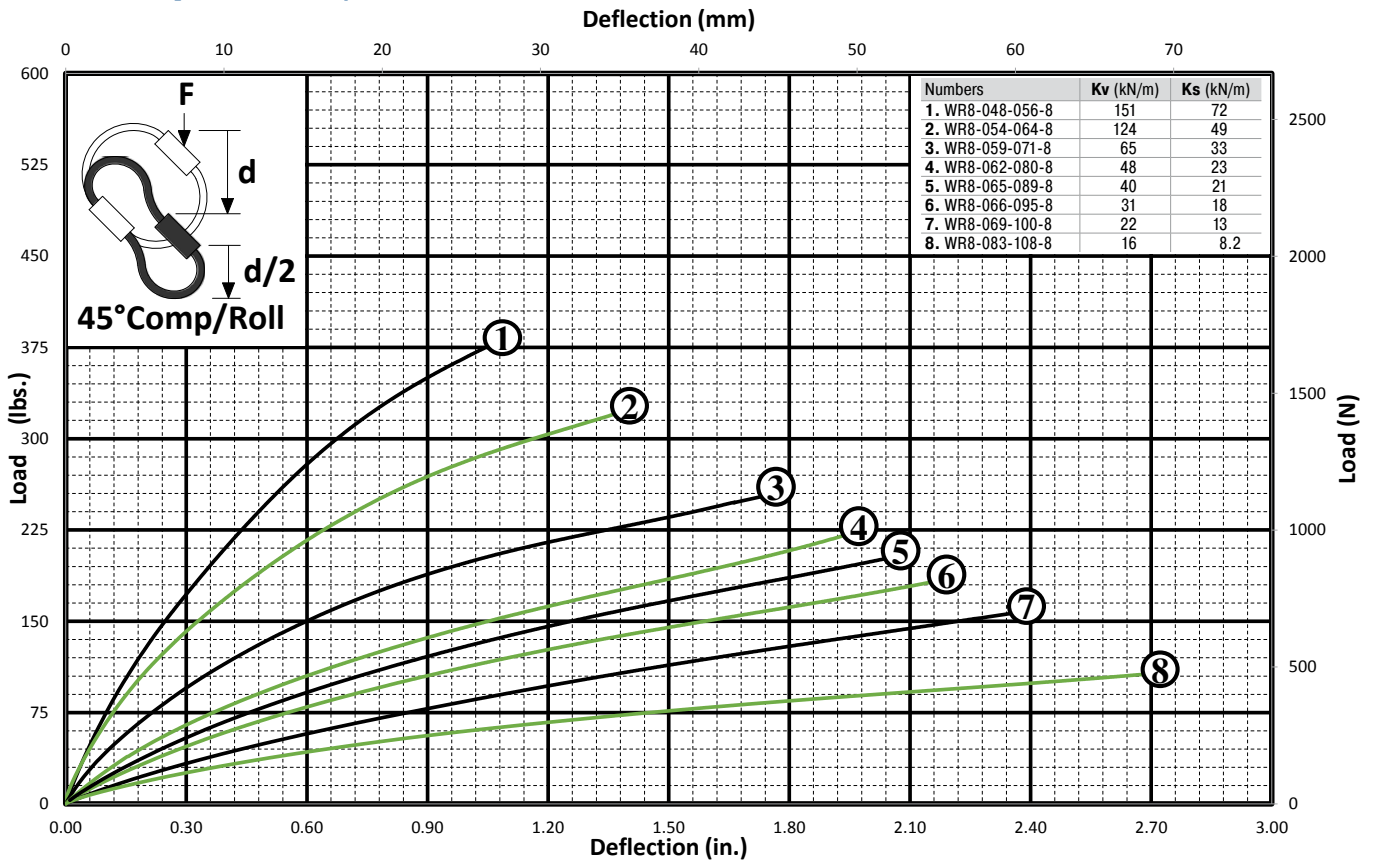

### 45° Tension/Roll

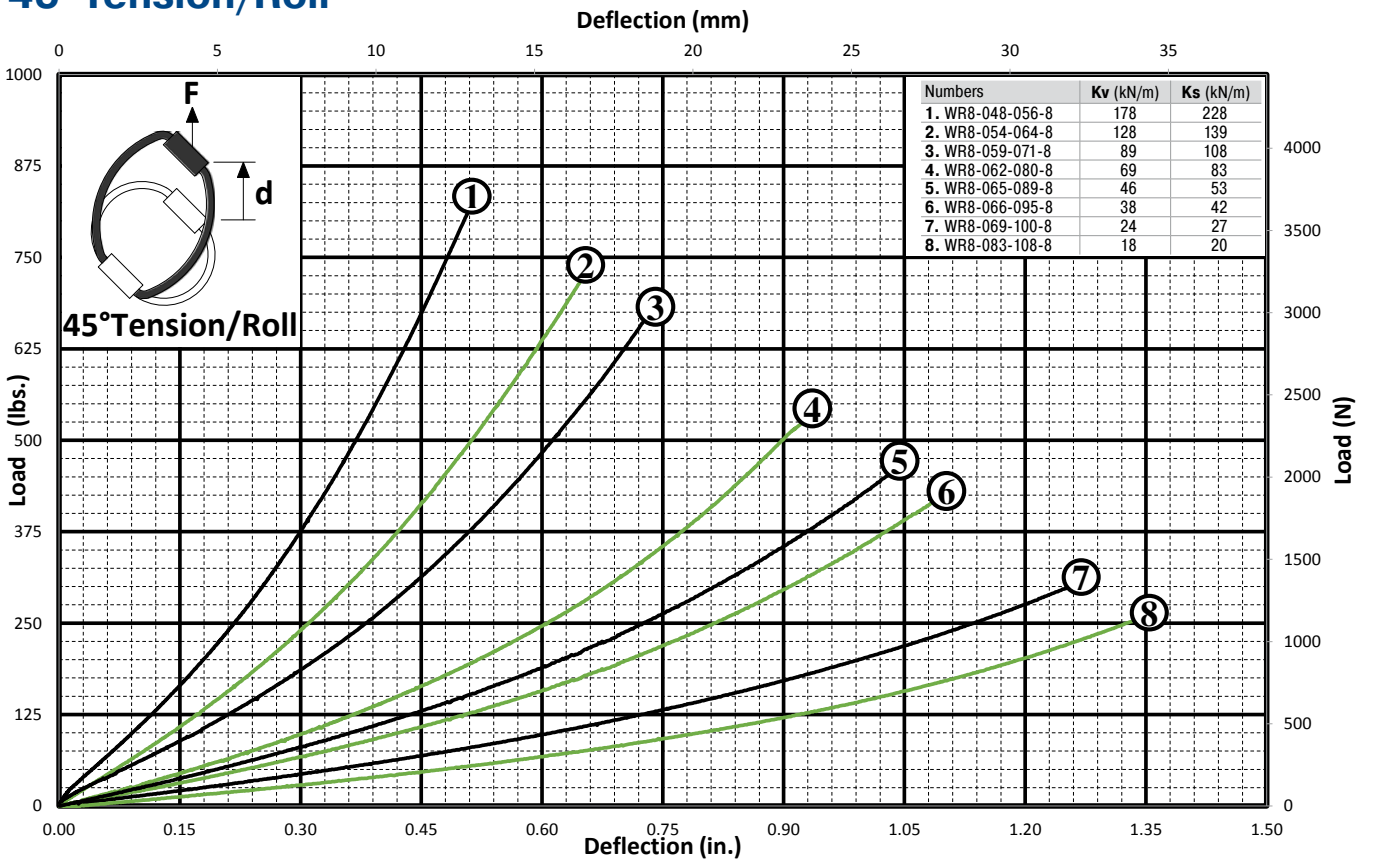

Product also available in stainless steel



# WR10

## Helical Isolator

7.94 mm (5/16") Diameter Cable



### Features

- Rugged all metal construction
- Fail safe construction
- Long life and maintenance free
- Three axis capability (6 dof)
- High damping: C/cc ≈ 0.15 to 0.20

### Operating temperature range

-130°C to +260°C

### Material

- Cable: 300 Series SS per MIL-W-83420 or RR-W-410
- Screws: 300 Series SS passivated IAW ASTM A967
- Inserts: 300 Series SS (alum bars only)
- Retainer bars: Standard: 6061-T6 Alum alloy/ Chem film IAW MIL-DTL-5541, TYPE II, Class 3

### Note

- Mounting hole tolerances: ±0.25 mm
- Add 0.26 kg to Isolator weight for all stainless steel versions

### On request

Special materials, size, mounting holes, finish, etc. available

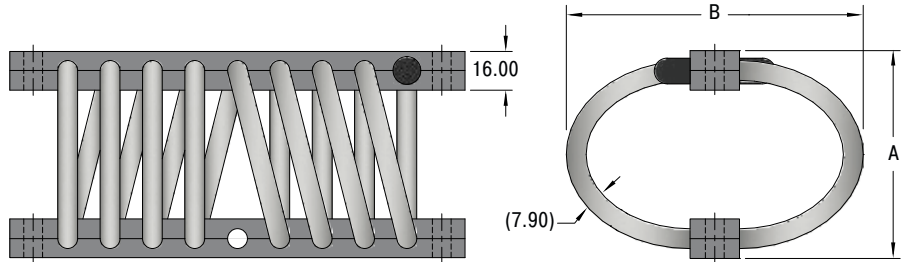
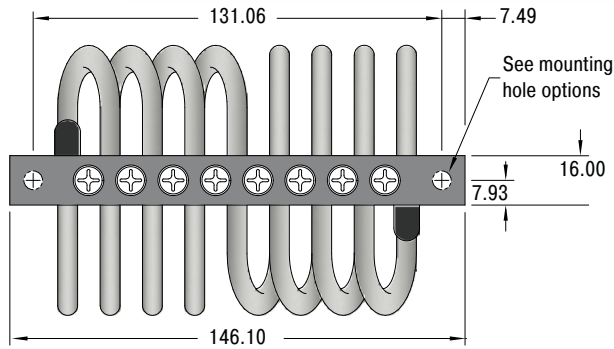

### Performance

TYPES	A (+/- 0.8) mm	B mm	Compression			Shear/Roll (Average)			Weight kg
			Kv (Vibe) kN/m	Ks (Shock) kN/m	Deflection max. mm	Kv (Vibe) kN/m	Ks (Shock) kN/m	Deflection max. mm	
WR10-055-059-8	54.6	59.2	432	328	17.8	128	173	17.8	0.486
WR10-061-067-8	60.5	66.8	335	214	24.1	96	105	24.1	0.495
WR10-065-074-8	65.0	74.4	189	141	29.2	77	87	29.2	0.522
WR10-069-083-8	68.6	82.8	168	115	31.8	51	62	31.8	0.568
WR10-071-092-8	71.1	92.2	114	81	34.3	38	41	34.3	0.608
WR10-072-099-8	72.4	98.6	95	68	35.6	36	38	35.6	0.631
WR10-075-104-8	74.9	103.6	83	59	38.1	29	31	38.1	0.654
WR10-089-111-8	88.9	111.3	61	39	52.1	18	21	52.1	0.717

### Ordering Example

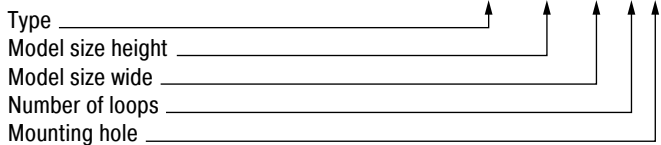

### Mounting Hole Options

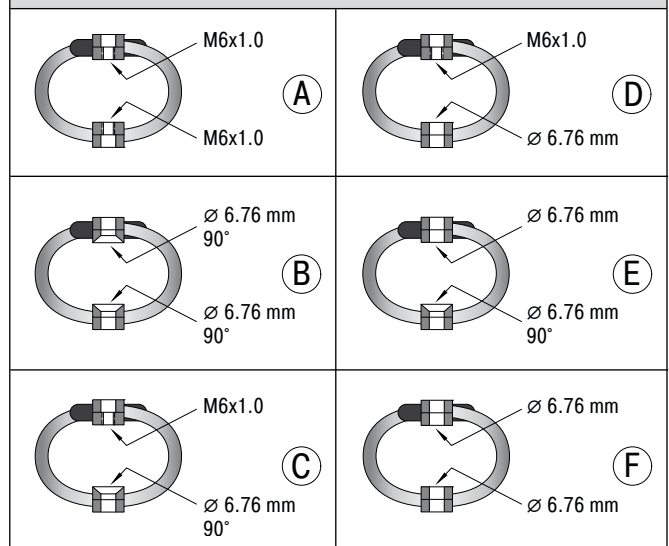

Issue 07.2020 – Specifications subject to change

### Compression

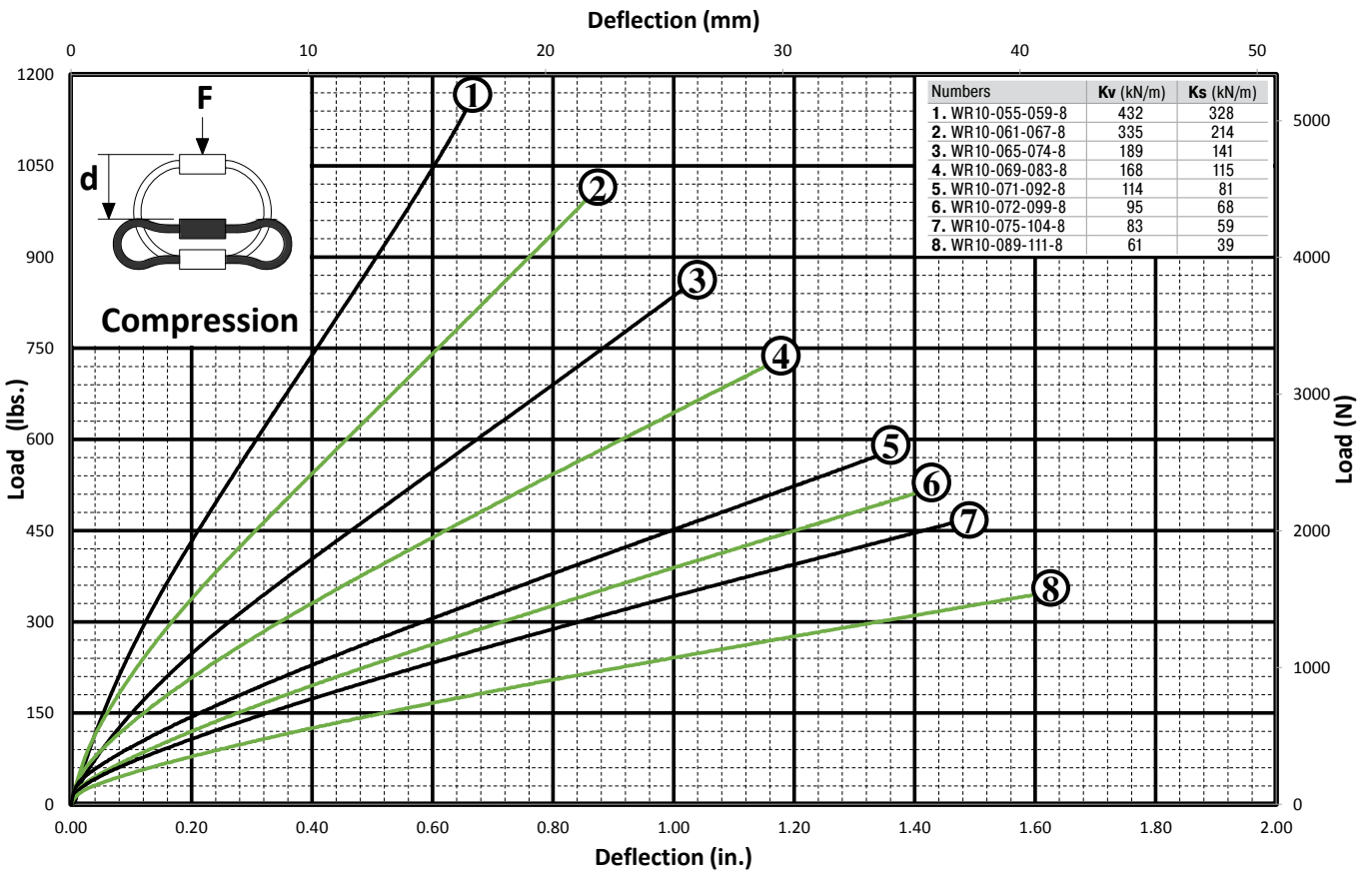

### Tension

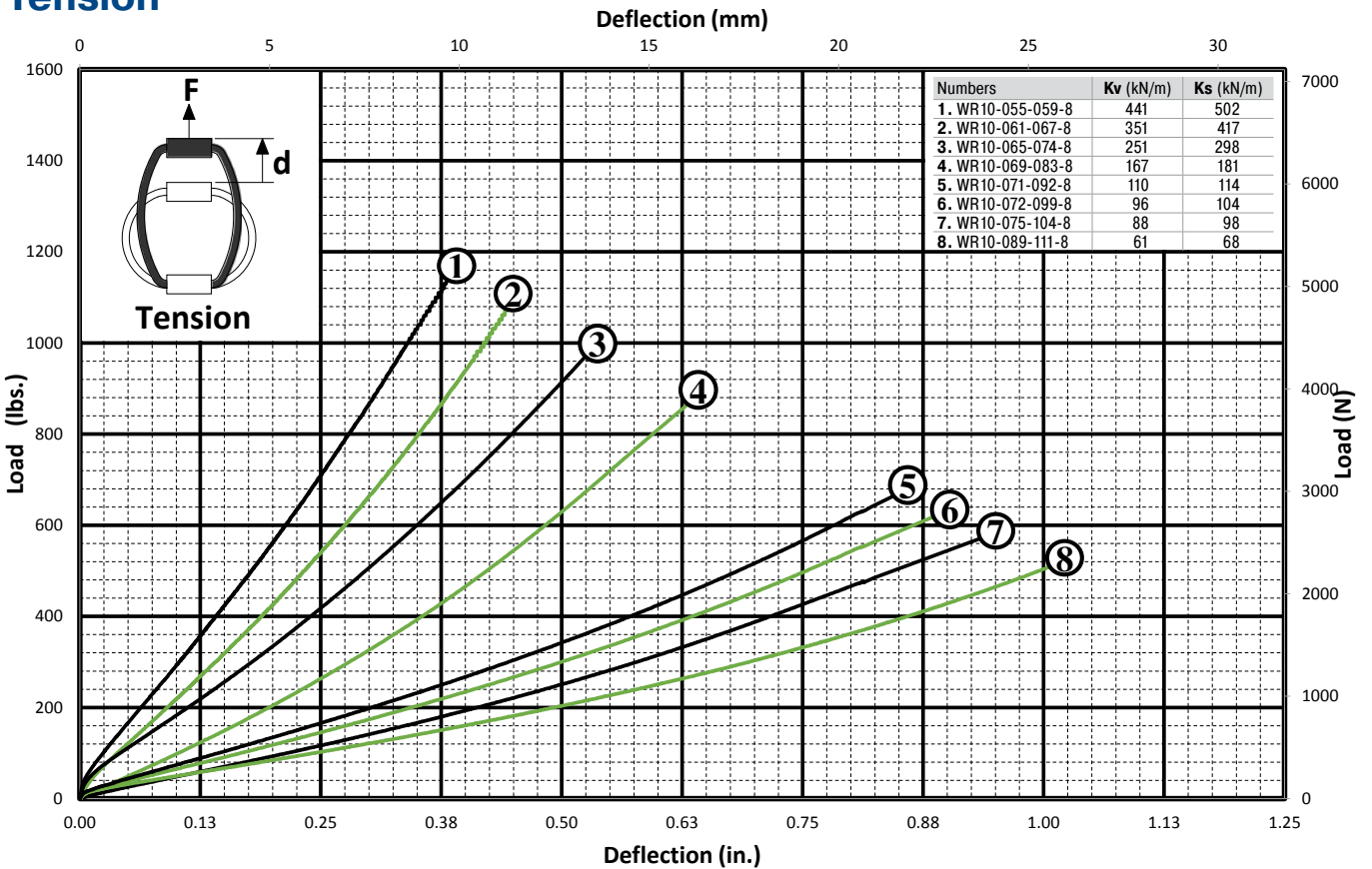

Issue 07.2020 – Specifications subject to change

### Shear

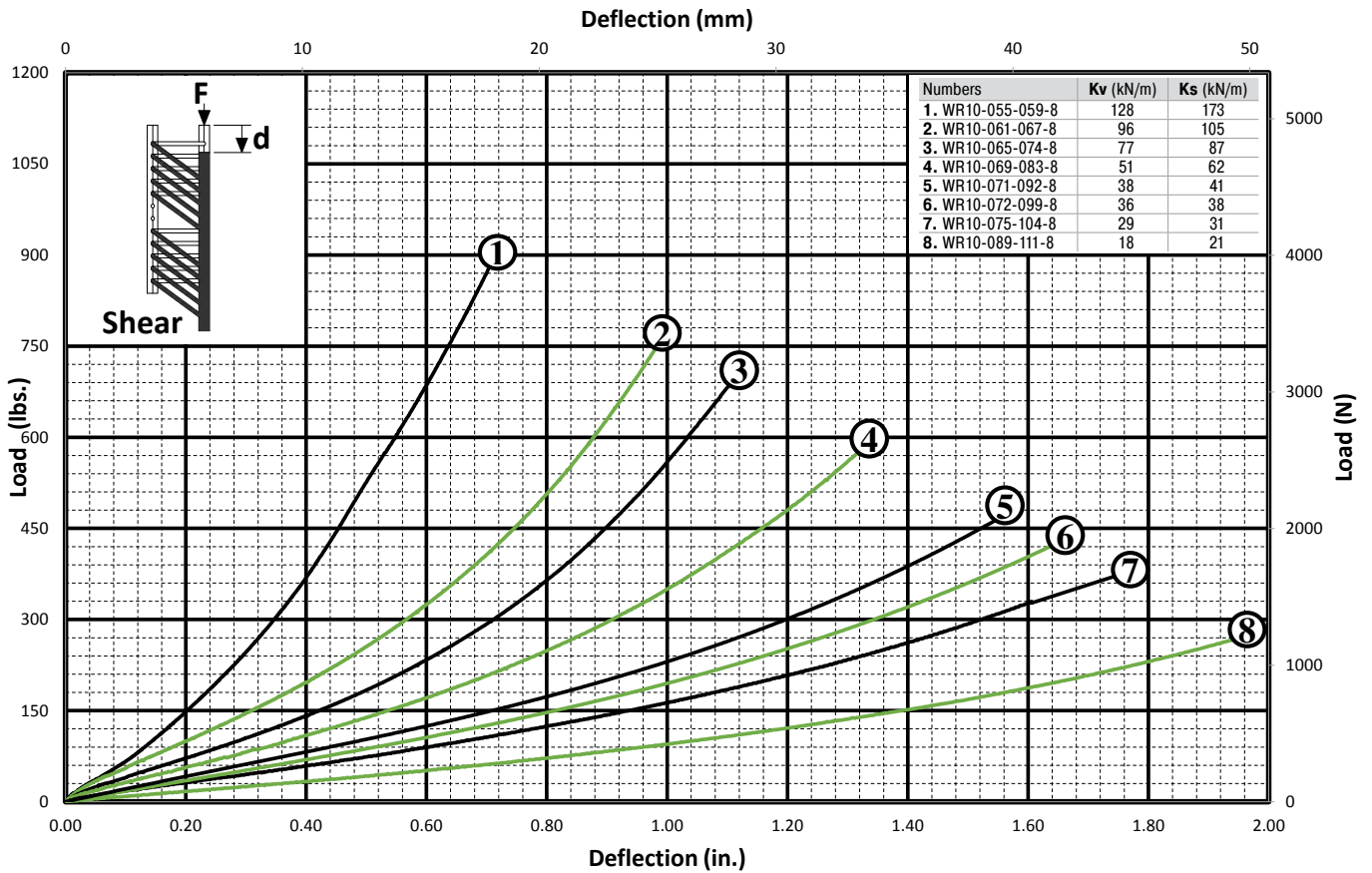

### Roll

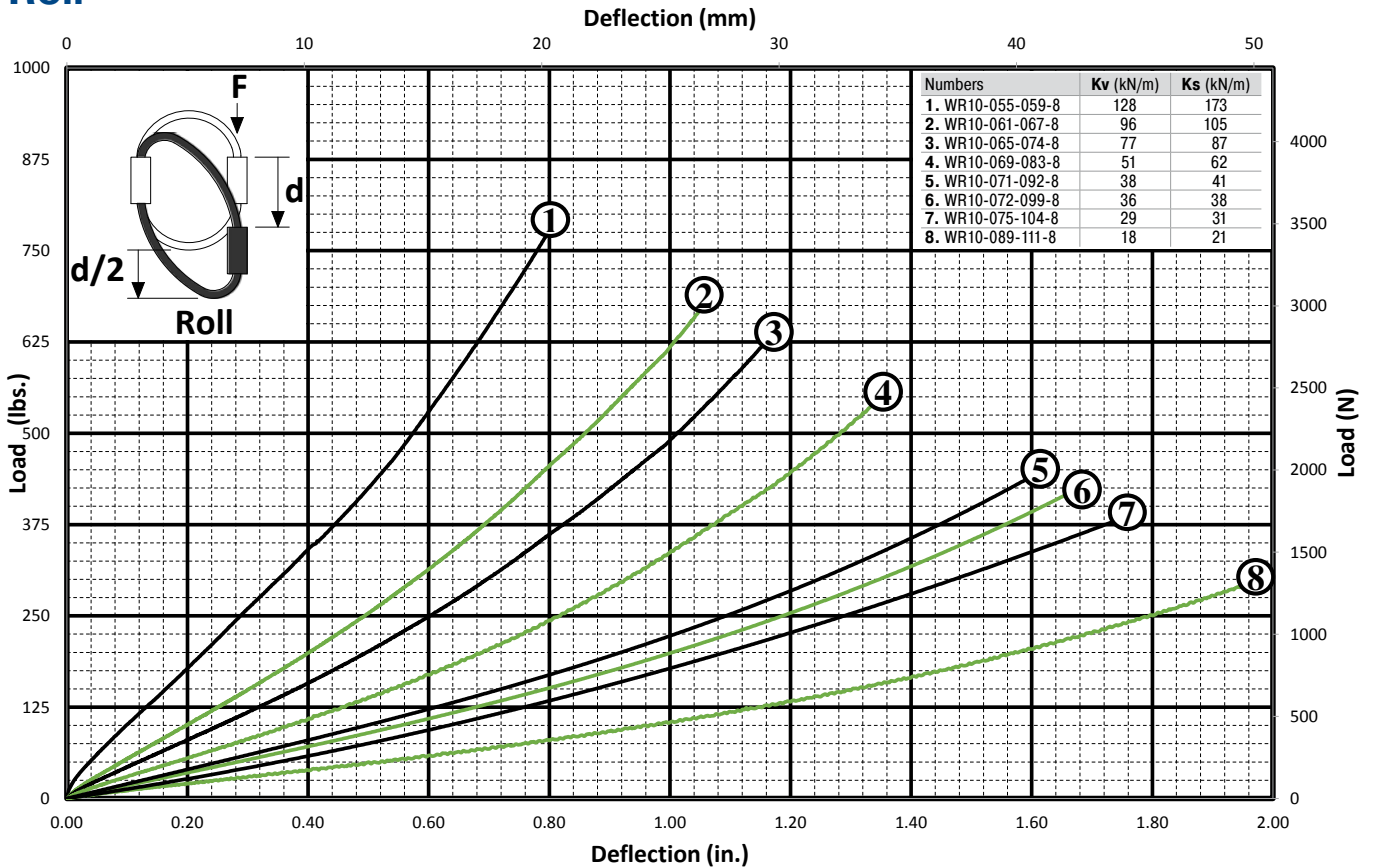

### 45° Compression/Roll

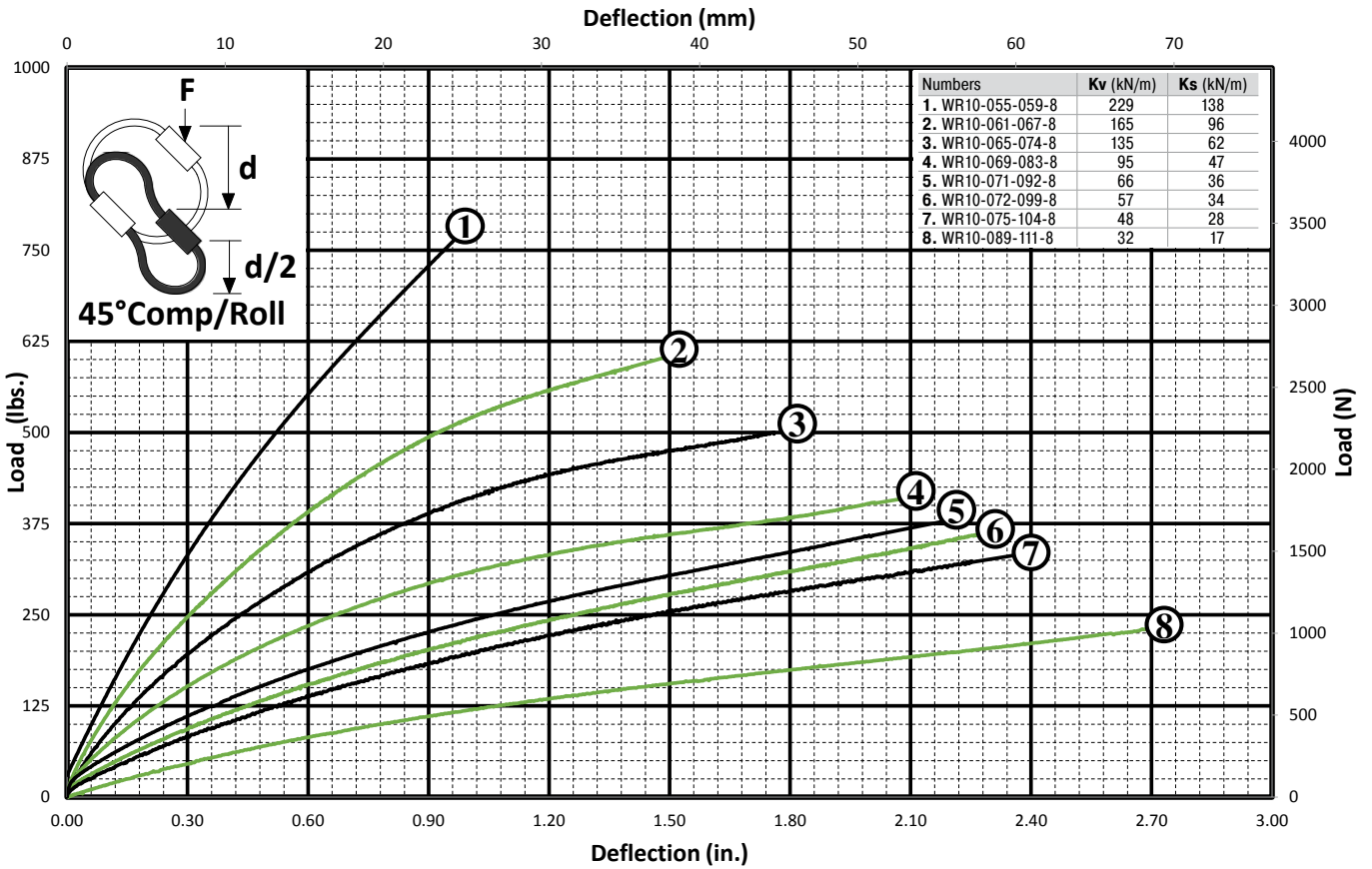

### 45° Tension/Roll

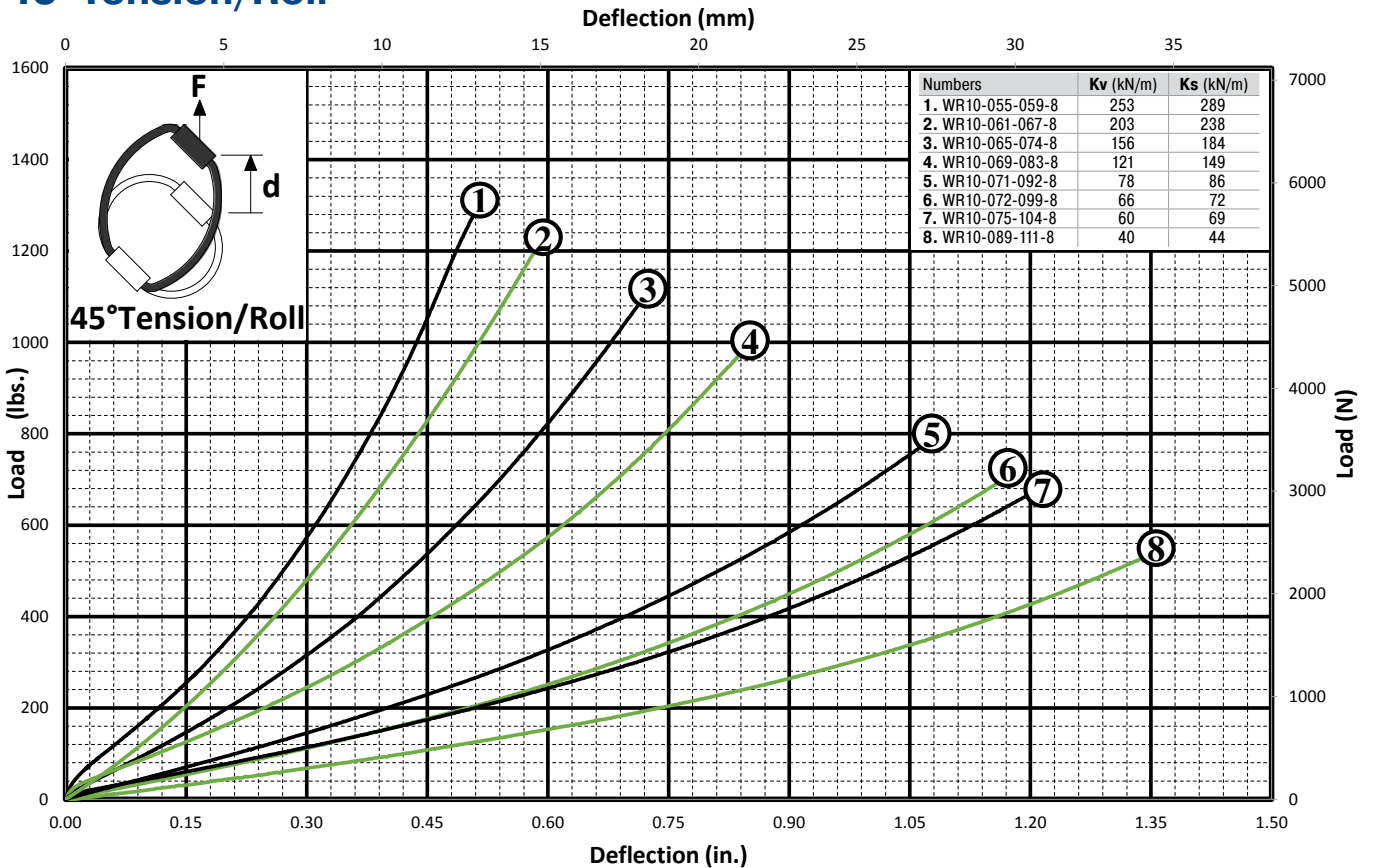

Issue 07.2020 – Specifications subject to change



Product also available in stainless steel



# WR12A

## Helical Isolator

### 9.53 mm (3/8") Diameter Cable



#### Features

- Rugged all metal construction
- Fail safe construction
- Long life and maintenance free
- Three axis capability (6 dof)
- High damping: C/cc ≈ 0.15 to 0.20

#### Operating temperature range

-130°C to +260°C

#### Material

- Cable: 300 Series SS per MIL-W-83420 or RR-W-410
- Screws: 300 Series SS passivated IAW ASTM A967
- Inserts: 300 Series SS (alum bars only)
- Retainer bars: Standard: 6061-T6 Alum alloy/ Chem film IAW MIL-DTL-5541, TYPE II, Class 3

#### Note

- Mounting hole tolerances: ±0.25 mm
- Add 0.51 kg to Isolator weight for all stainless steel versions

#### On request

Special materials, size, mounting holes, finish, etc. available

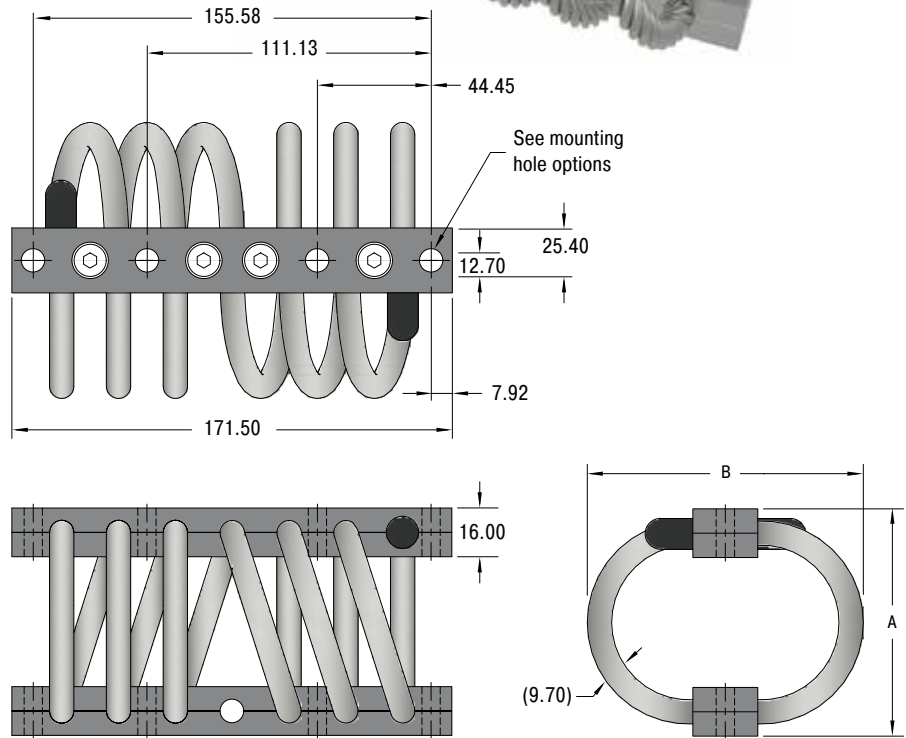

#### Performance

TYPES	A (+/- 0.8) mm	B mm	Compression			Shear/Roll (Average)			Weight kg
			Kv (Vibe) kN/m	Ks (Shock) kN/m	Deflection max. mm	Kv (Vibe) kN/m	Ks (Shock) kN/m	Deflection max. mm	
WR12A-071-084-6	71.1	84.1	226	144	31.8	67	96	31.8	0.790
WR12A-074-089-6	73.7	88.9	197	123	34.3	59	70	34.3	0.800
WR12A-076-105-6	76.2	104.9	174	101	36.8	56	61	36.8	0.870
WR12A-083-108-6	82.6	108.0	141	83	43.2	55	53	43.2	0.900
WR12A-089-108-6	88.9	108.0	134	76	49.5	43	46	49.5	0.930
WR12A-105-121-6	104.9	120.7	84	48	66.0	20	33	66.0	1.020
WR12A-108-140-6	108.0	139.7	63	34	68.6	19	21	68.6	1.110

#### Ordering Example

WR12A-071-084-6-A

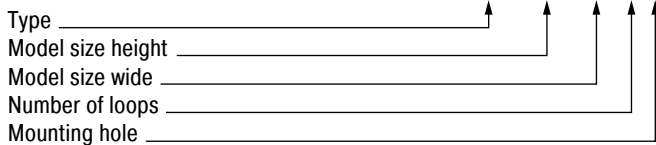

#### Mounting Hole Options

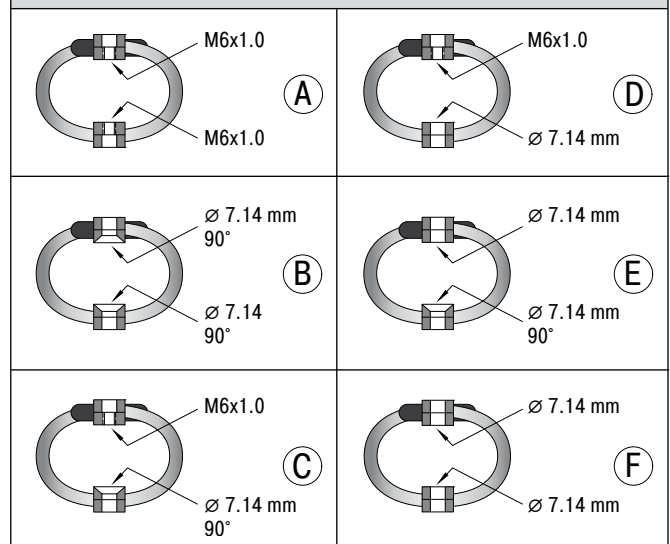

Issue 07.2020 – Specifications subject to change

### Compression

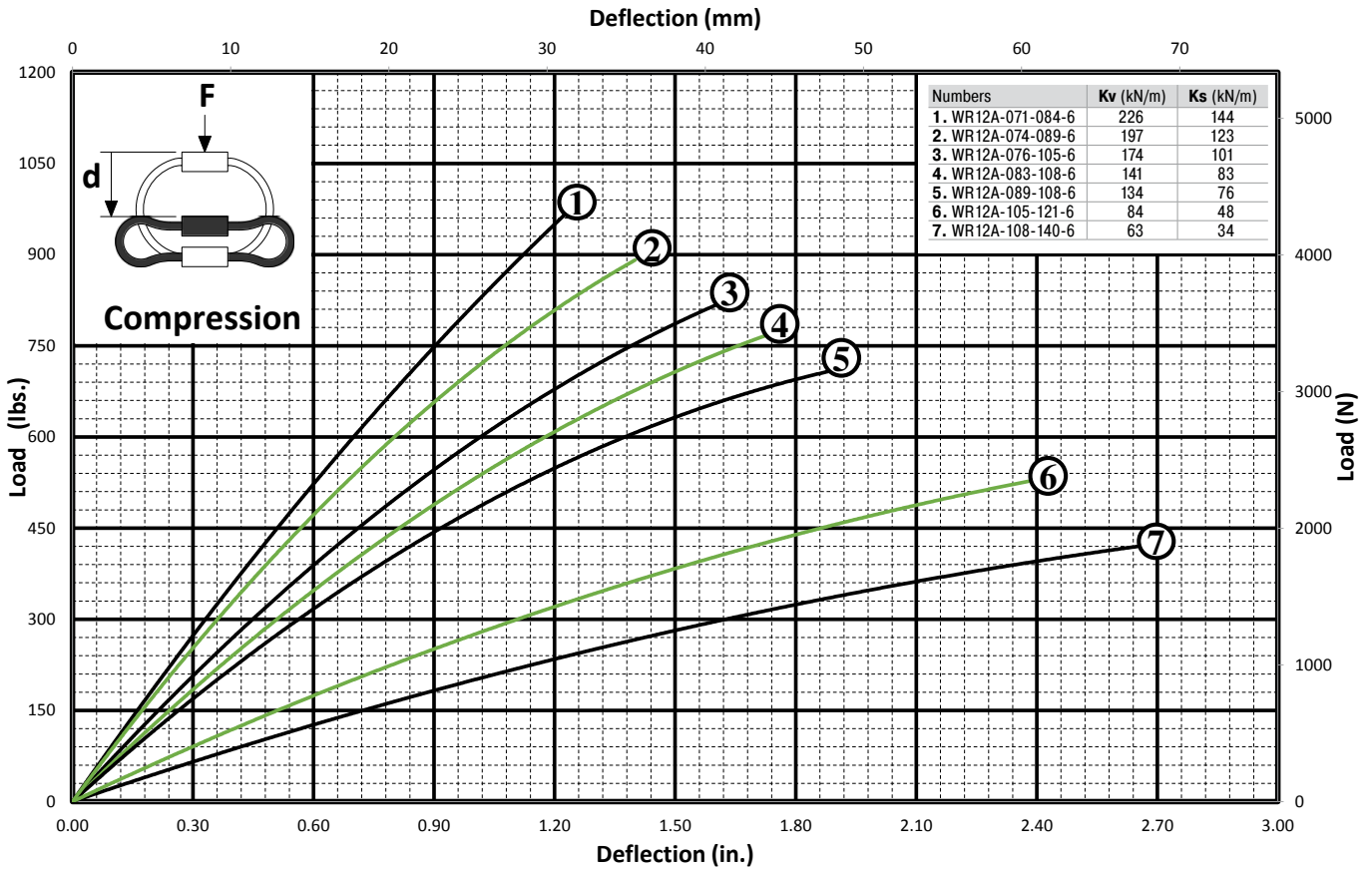

### Tension

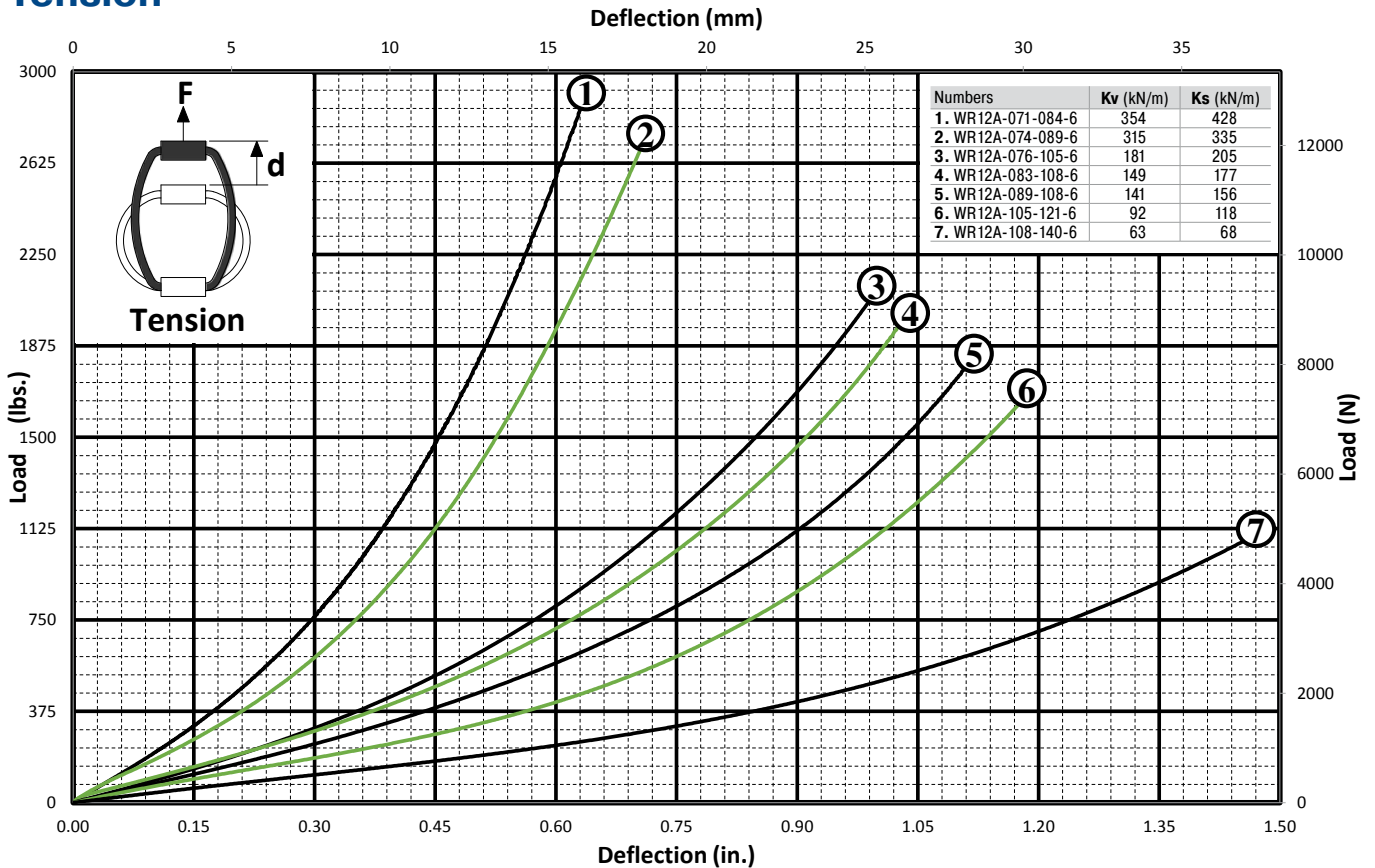

Issue 07.2020 – Specifications subject to change

### Shear

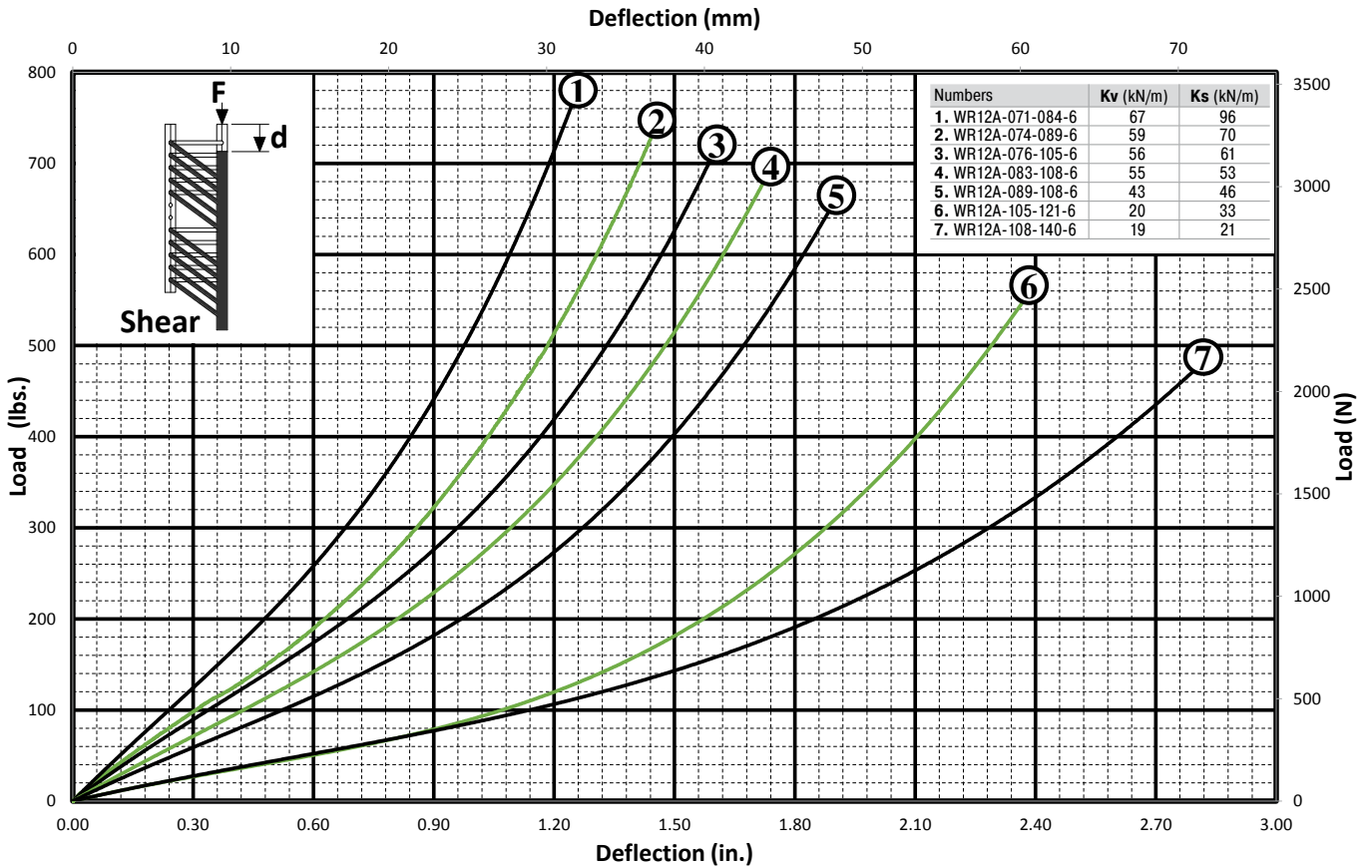

### Roll

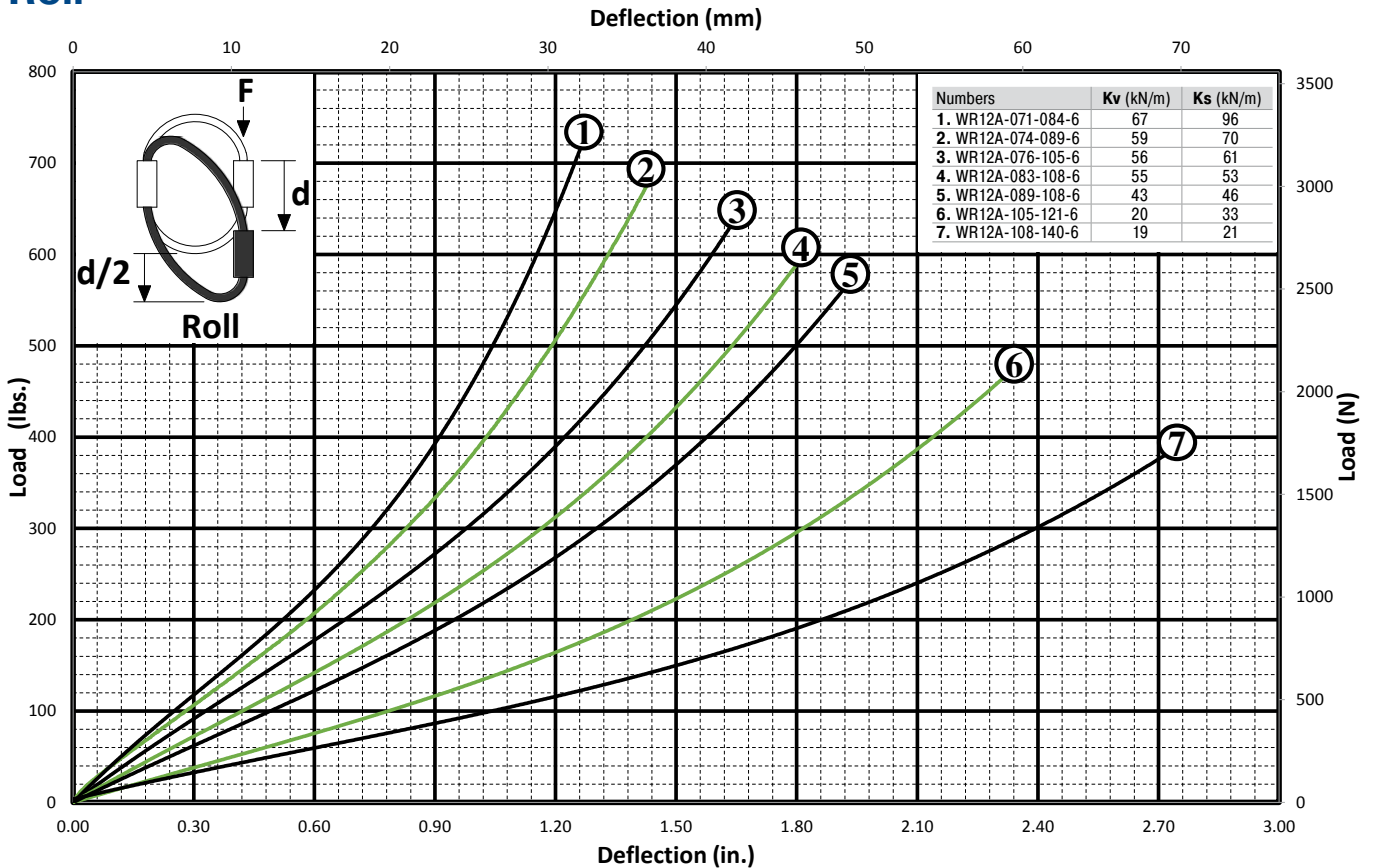

### 45° Compression/Roll

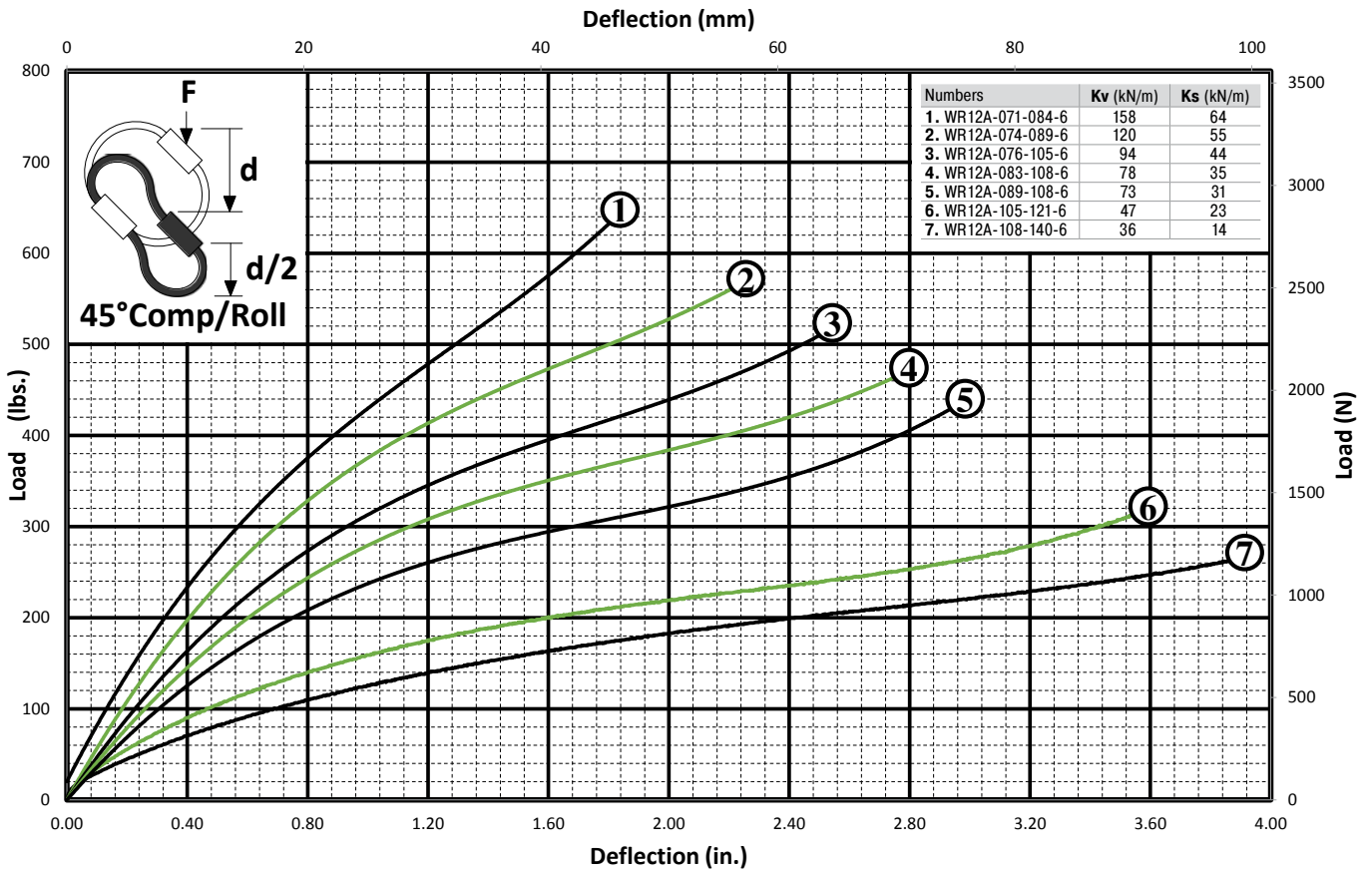

### 45° Tension/Roll

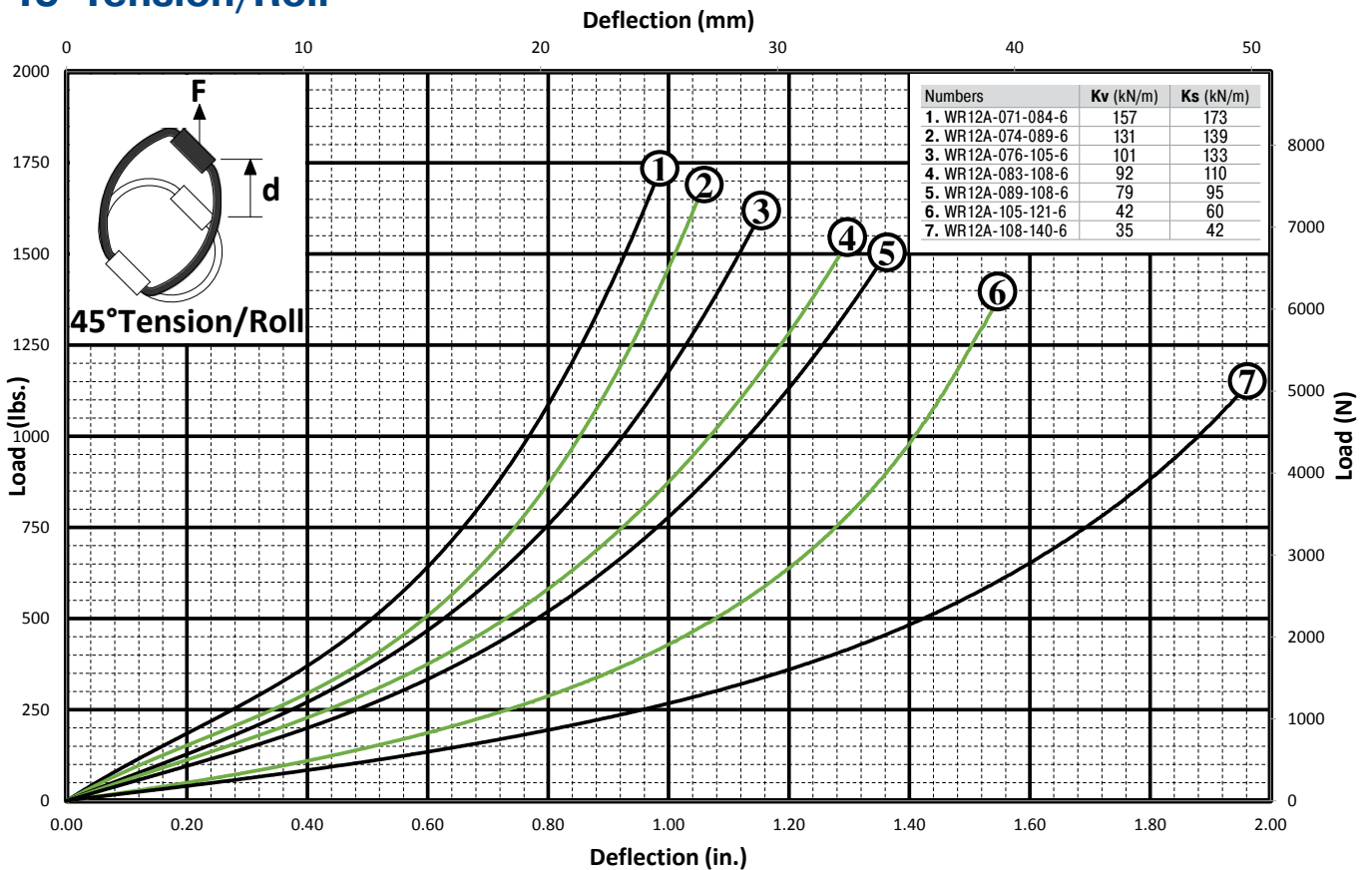

Issue 07.2020 – Specifications subject to change

Product also available in stainless steel



# WR12

## Helical Isolator

### 9.53 mm (3/8") Diameter Cable



#### Features

- Rugged all metal construction
- Fail safe construction
- Long life and maintenance free
- Three axis capability (6 dof)
- High damping: C/cc ≈ 0.15 to 0.20

#### Operating temperature range

-130°C to +260°C

#### Material

- Cable: 300 Series SS per MIL-W-83420 or RR-W-410
- Screws: 300 Series SS passivated IAW ASTM A967
- Inserts: 300 Series SS (Alum bars only)
- Retainer bars: Standard: 6061-T6 Alum alloy/ Chem film IAW MIL-DTL-5541, TYPE II, Class 3

#### Note

- Mounting hole tolerances: ±0.25 mm
- Add 0.62 kg to Isolator weight for all stainless steel versions

#### On request

Special materials, size, mounting holes, finish, etc. available

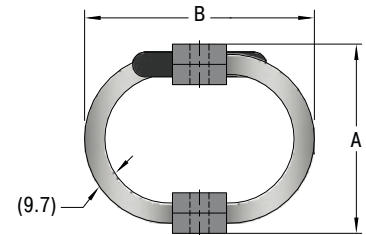
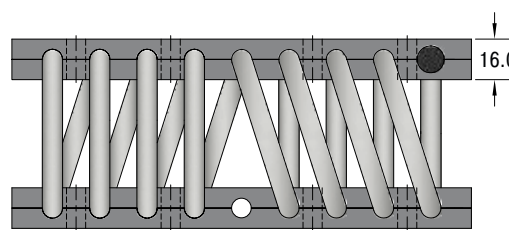
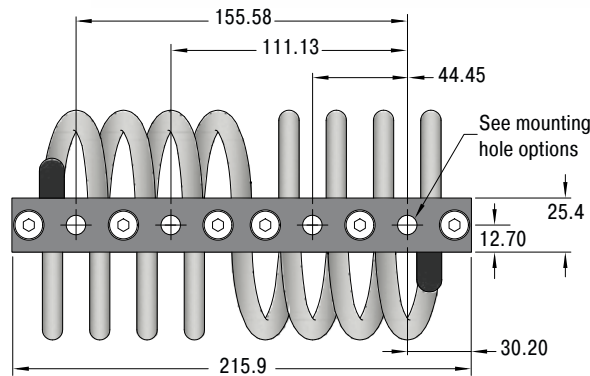

#### Performance

TYPEN	A (+/- 0.8) mm	B mm	Compression			Shear/Roll (Average)			Weight kg
			Kv (Vibe) kN/m	Ks (Shock) kN/m	Deflection max. mm	Kv (Vibe) kN/m	Ks (Shock) kN/m	Deflection max. mm	
WR12-071-084-8	71.1	84.1	302	192	31.8	89	128	31.8	1.050
WR12-074-089-8	73.7	88.9	263	164	34.3	79	93	34.3	1.070
WR12-076-105-8	76.2	104.9	232	135	36.8	75	81	36.8	1.150
WR12-083-108-8	82.6	108.0	187	110	43.2	74	71	43.2	1.190
WR12-089-108-8	88.9	108.0	179	101	49.5	57	62	49.5	1.240
WR12-105-121-8	104.9	120.7	114	64	66.0	26	44	66.0	1.360
WR12-108-140-8	108.0	139.7	84	45	68.6	25	28	68.6	1.480

#### Ordering Example

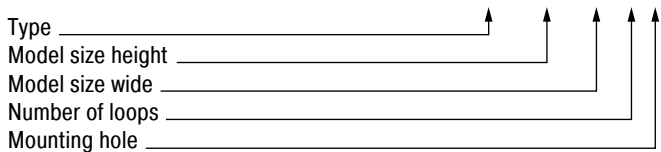

#### Mounting Hole Options

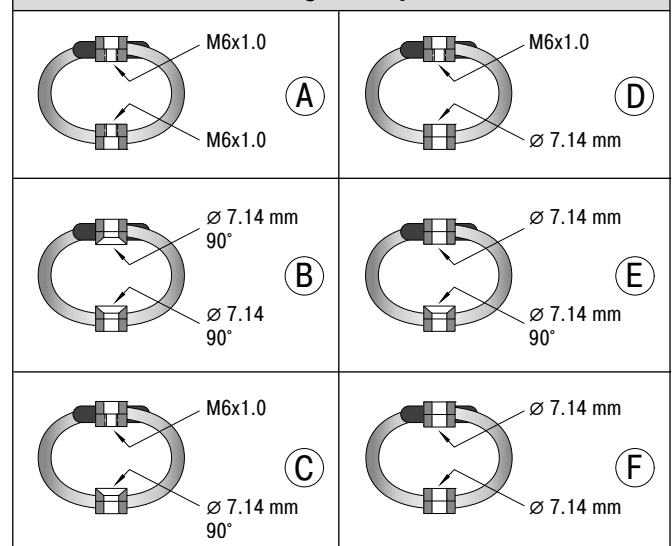

Issue 07.2020 – Specifications subject to change



### Compression

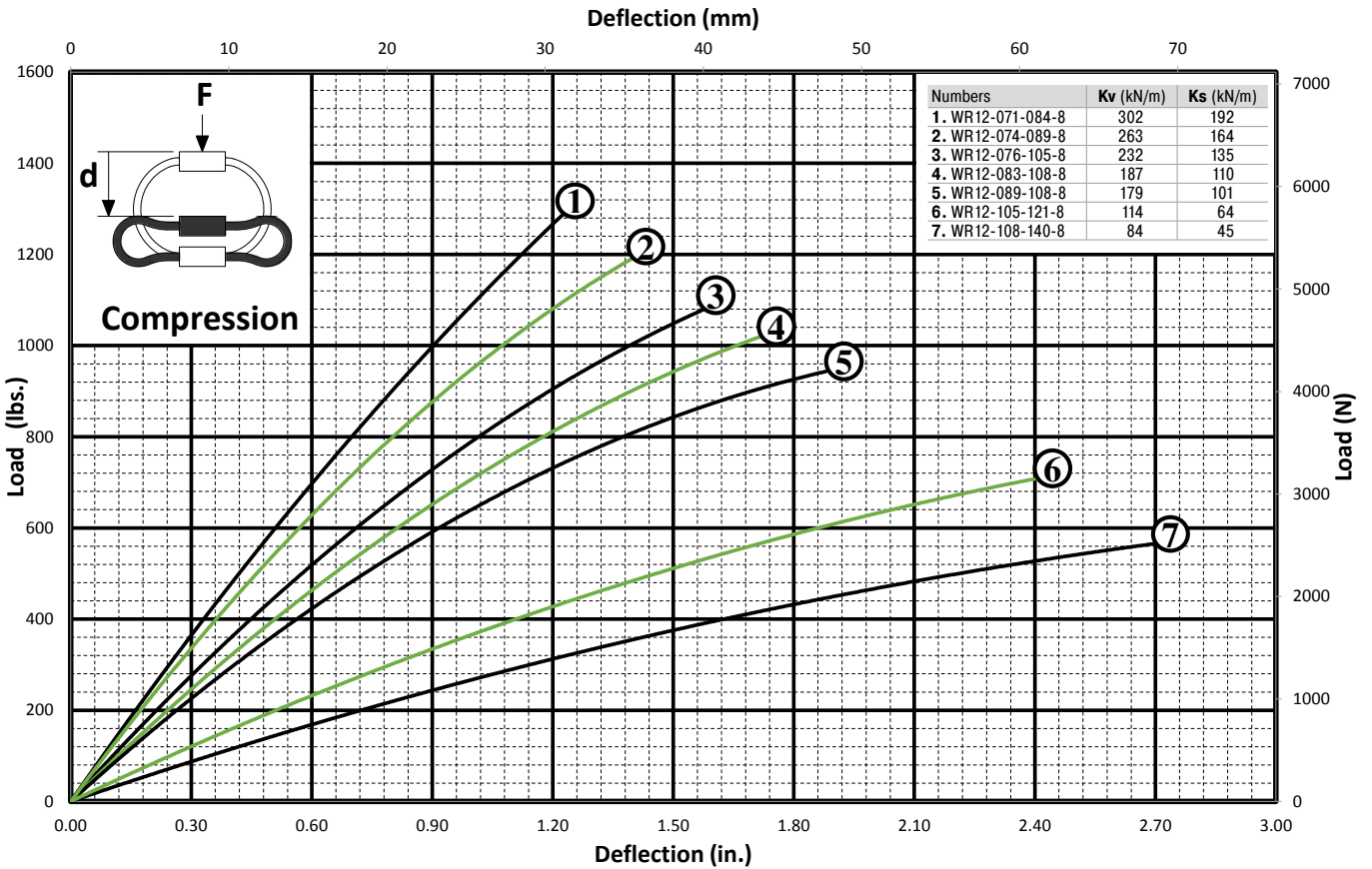

### Tension

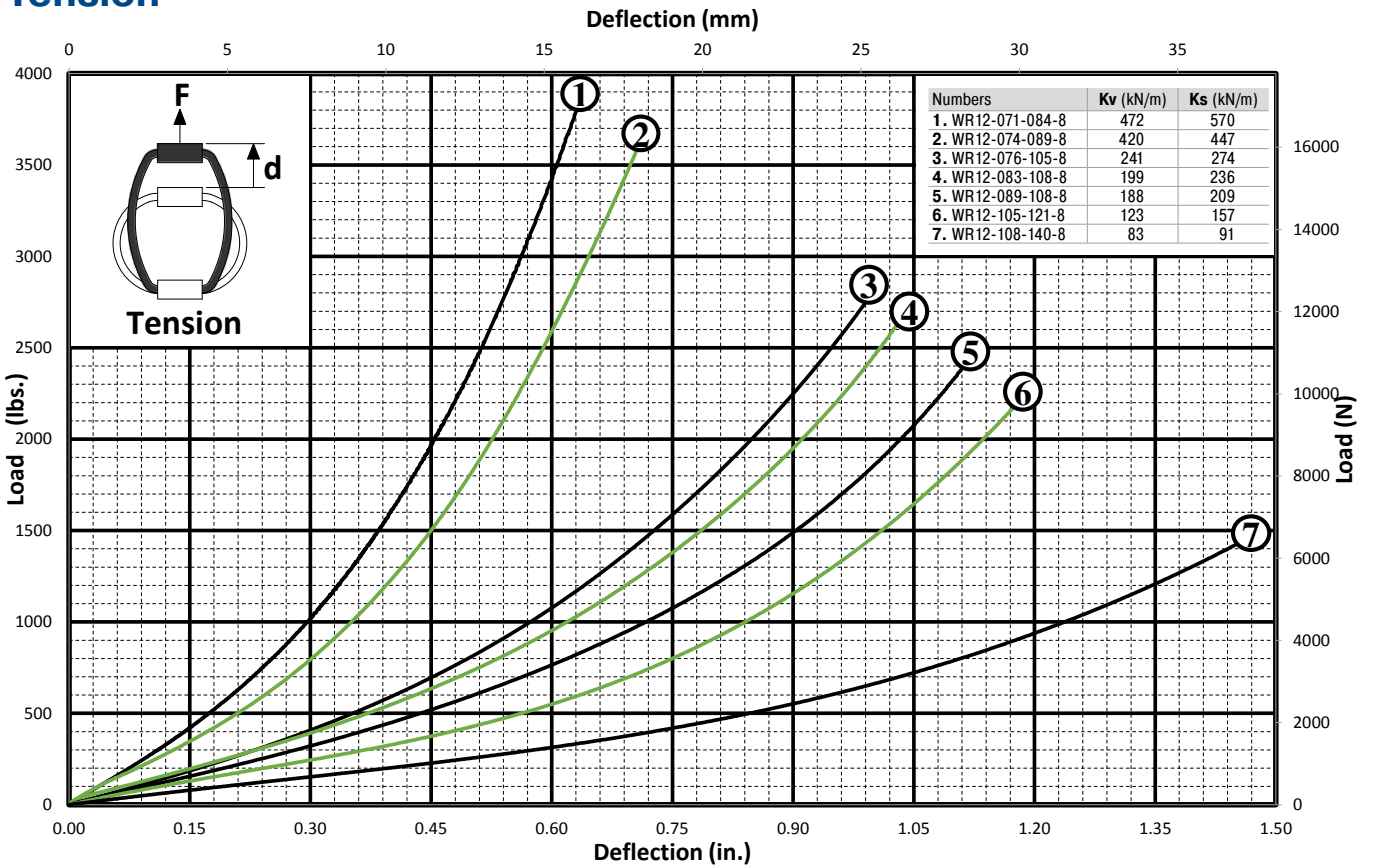

Issue 07.2020 – Specifications subject to change

### Shear

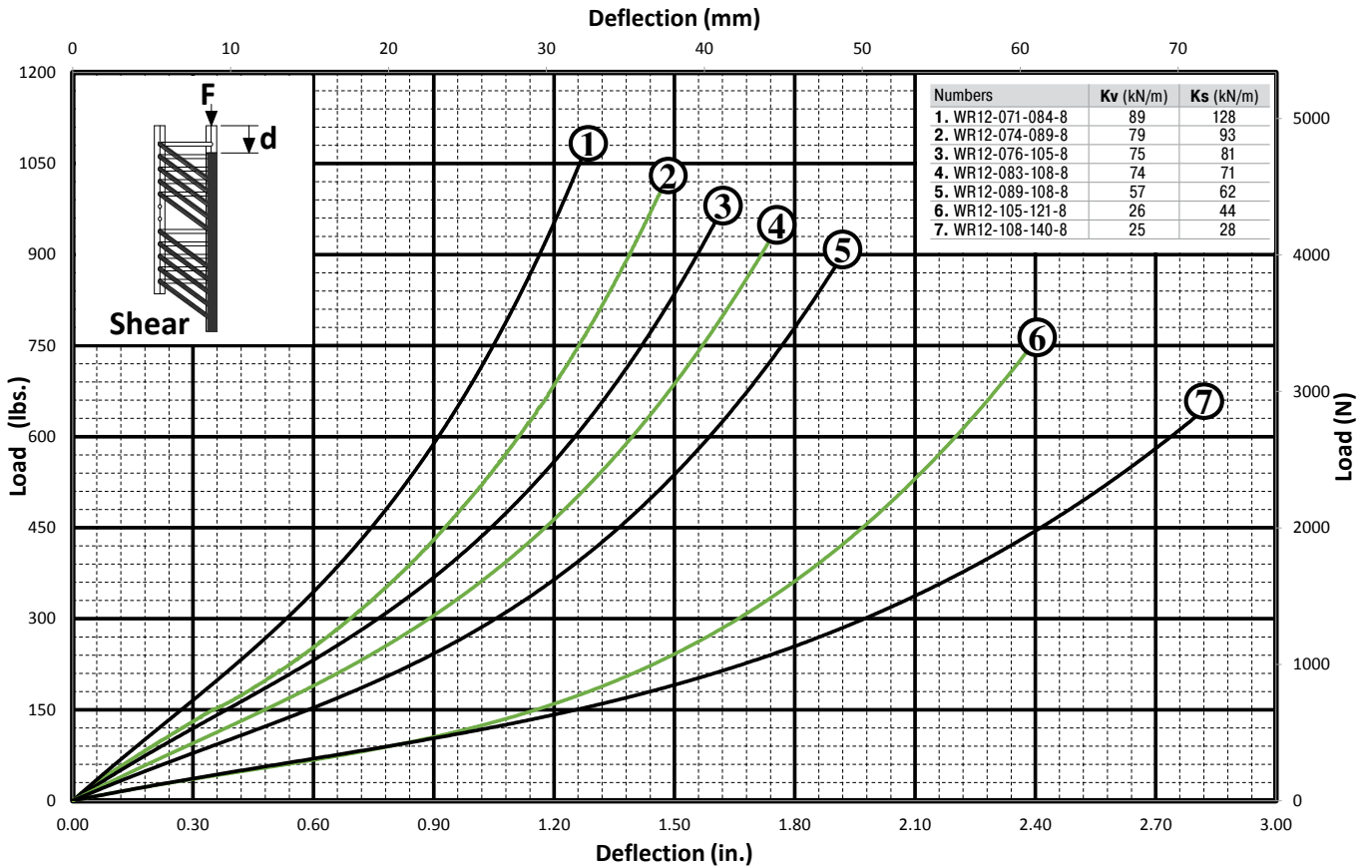

### Roll

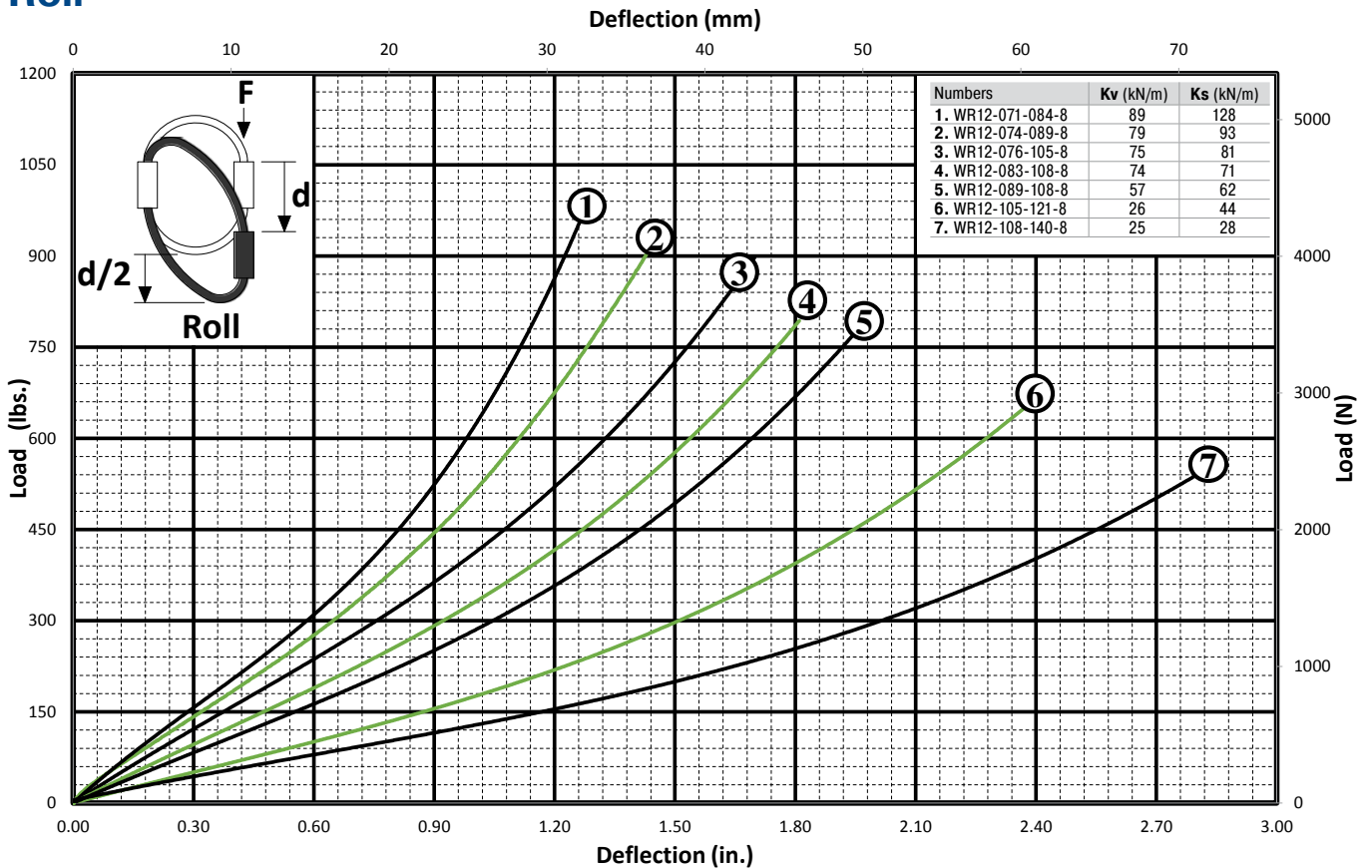

### 45° Compression/Roll

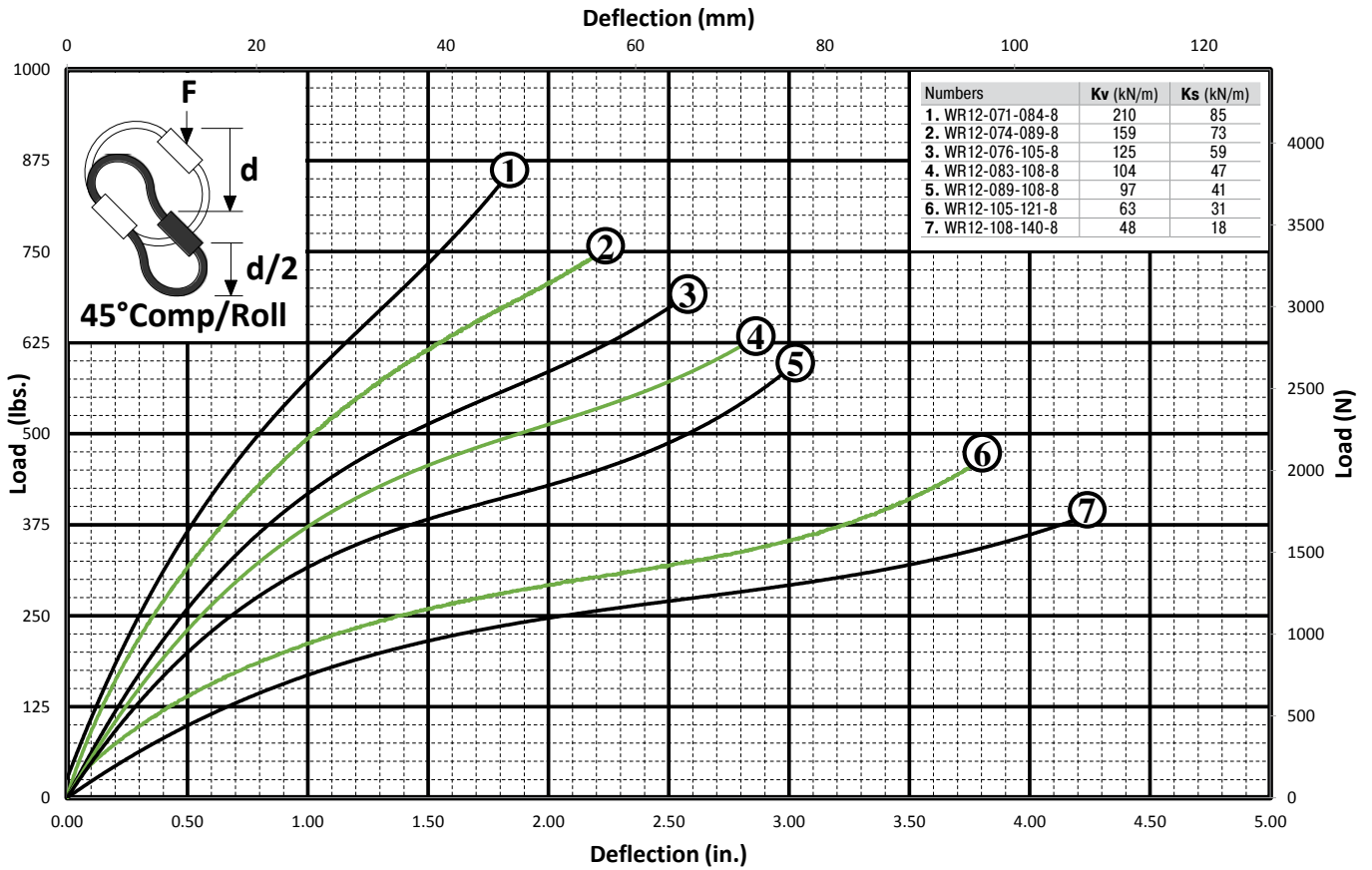

### 45° Tension/Roll

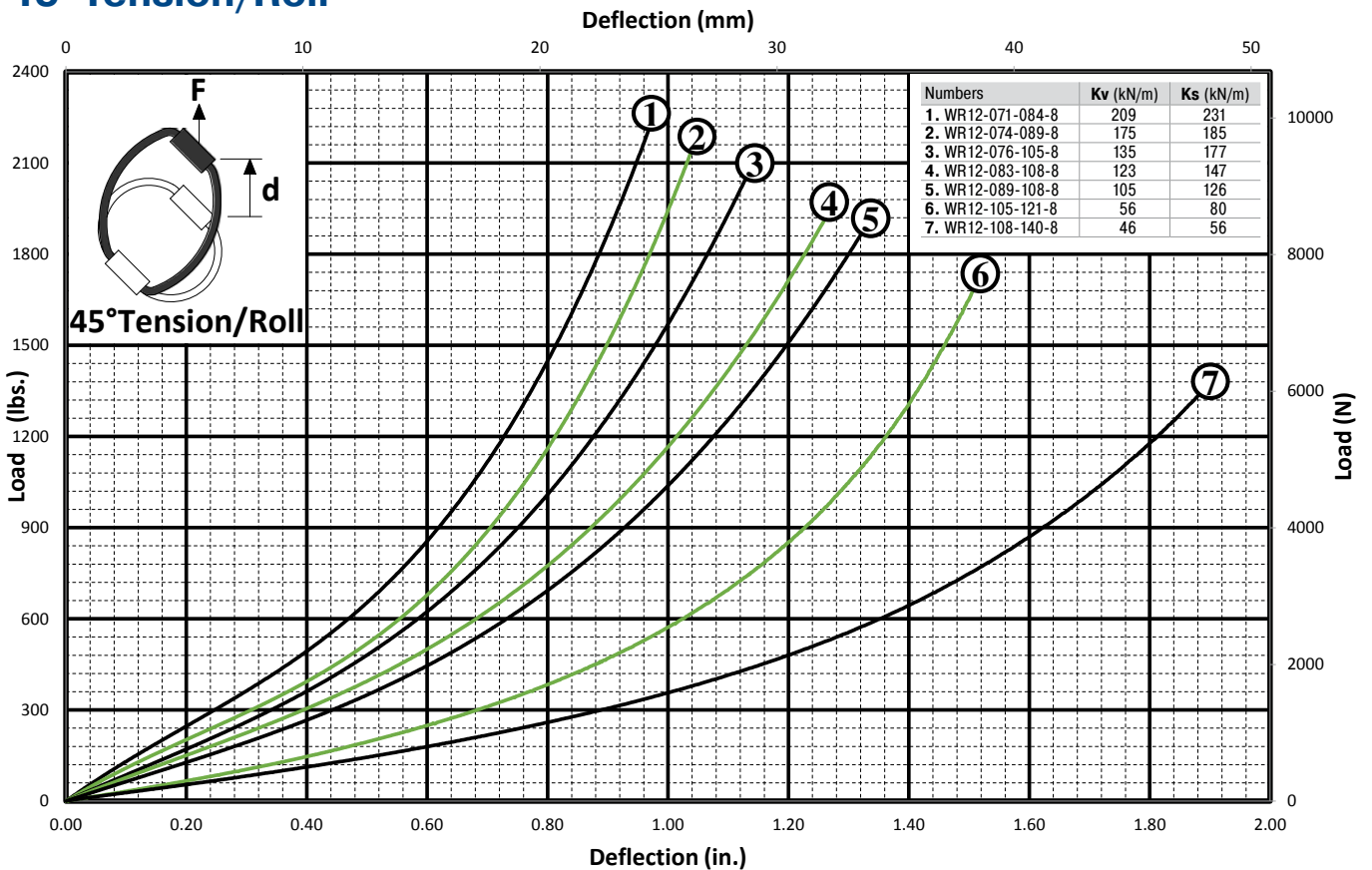

Issue 07.2020 – Specifications subject to change

Product also available in stainless steel



# WR16A

## Helical Isolator

12.70 mm (1/2") Diameter Cable



**Features**

- Rugged all metal construction
- Fail safe construction
- Long life and maintenance free
- Three axis capability (6 dof)
- High damping: C/cc ≈ 0.15 to 0.20

**Operating temperature range**

-130°C to +260°C

**Material**

- Cable: 300 Series SS per MIL-W-83420 or RR-W-410
- Screws: 300 Series SS passivated IAW ASTM A967
- Inserts: 300 Series SS (Alum bars only)
- Retainer bars: Standard: 6061-T6 Alum alloy/ Chem film IAW MIL-DTL-5541, TYPE II, Class 3

**Note**

- Mounting hole tolerances: ±0.25 mm
- Add 0.53 kg to Isolator weight for all stainless steel versions

**On request**

Special materials, size, mounting holes, finish, etc. available

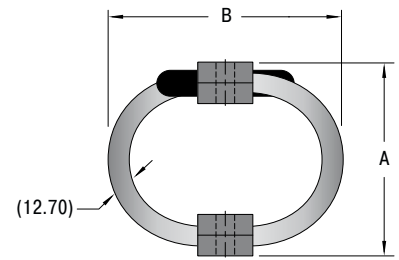
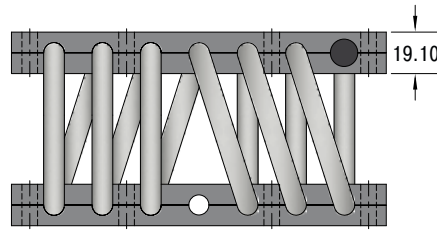
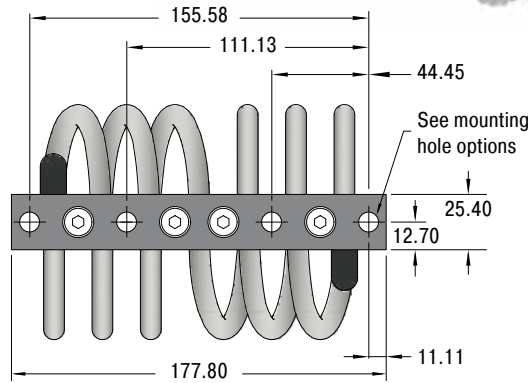

**Performance**

TYPEN	A (+/- 0.8) mm	B mm	Compression			Shear/Roll (Average)			Weight kg
			Kv (Vibe) kN/m	Ks (Shock) kN/m	Deflection max. mm	Kv (Vibe) kN/m	Ks (Shock) kN/m	Deflection max. mm	
WR16A-083-102-6	82.6	101.9	327	220	35.6	169	128	35.6	1.260
WR16A-089-105-6	88.9	104.9	310	197	41.9	94	108	41.9	1.270
WR16A-095-121-6	95.3	120.7	231	137	48.3	71	78	48.3	1.400
WR16A-108-133-6	108.0	133.4	143	86	61.0	44	50	61.0	1.570
WR16A-125-144-6	124.5	143.5	102	60	77.5	33	38	77.5	1.700
WR16A-137-158-6	137.2	157.7	72	45	90.2	23	31	90.2	1.850
WR16A-155-180-6	154.9	180.3	53	29	108.0	12	18	108.0	2.090

**Ordering Example**

WR16A-083-102-6-A

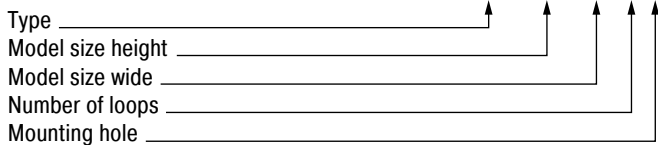

**Mounting Hole Options**

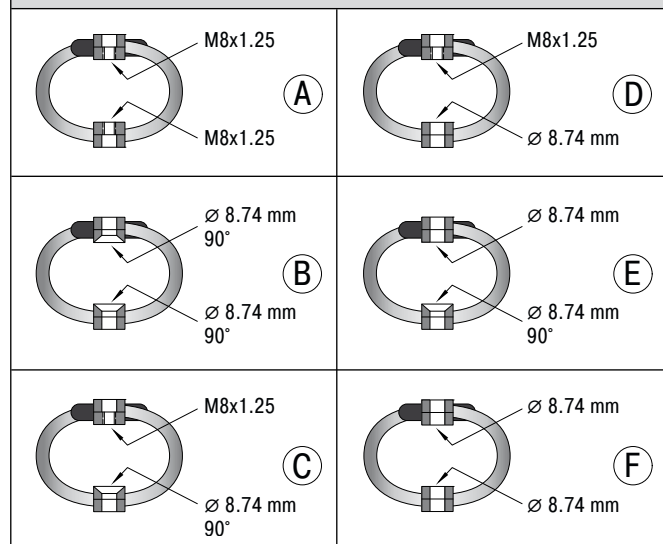

Issue 07.2020 – Specifications subject to change

### Compression

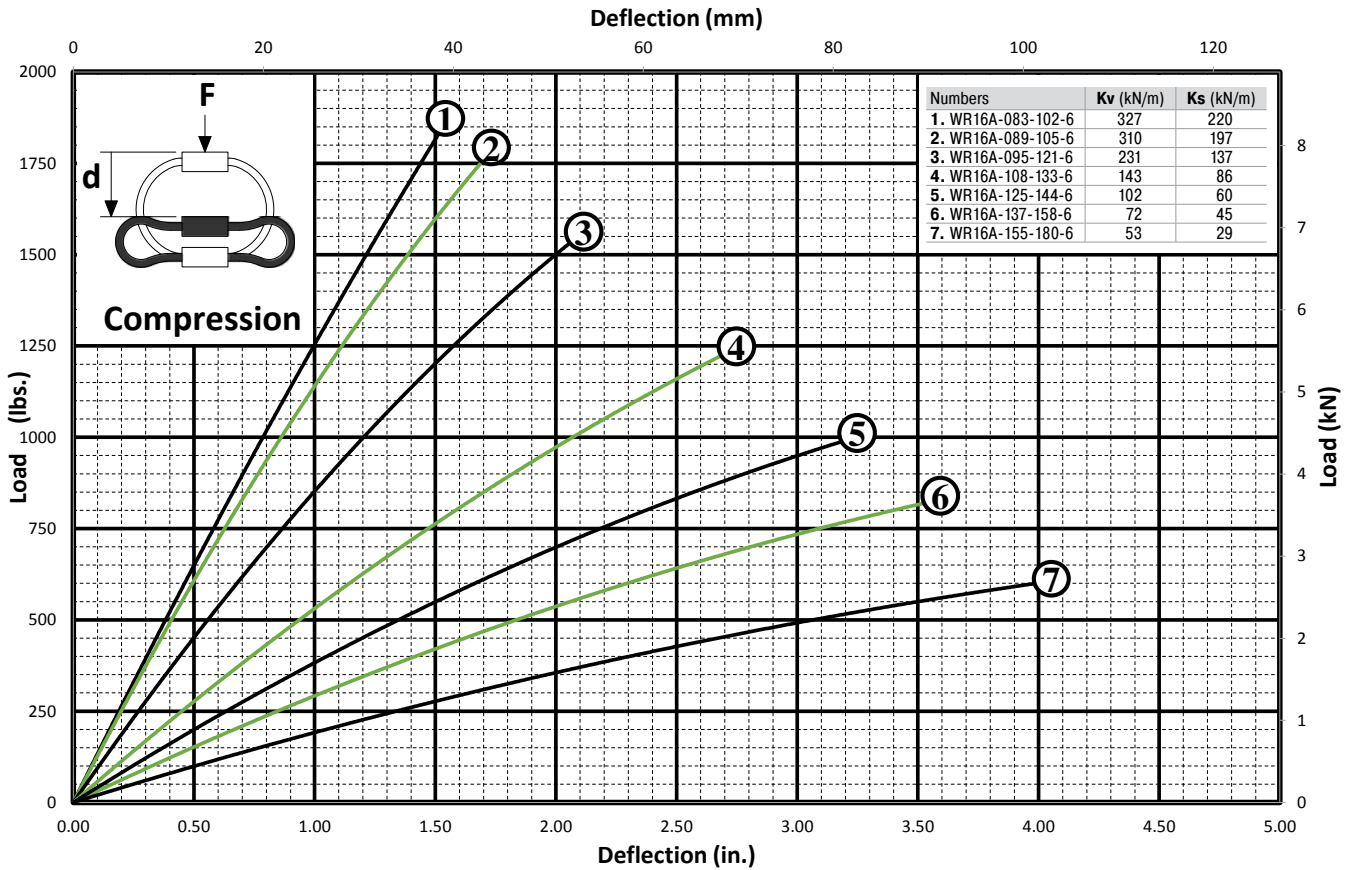

### Tension

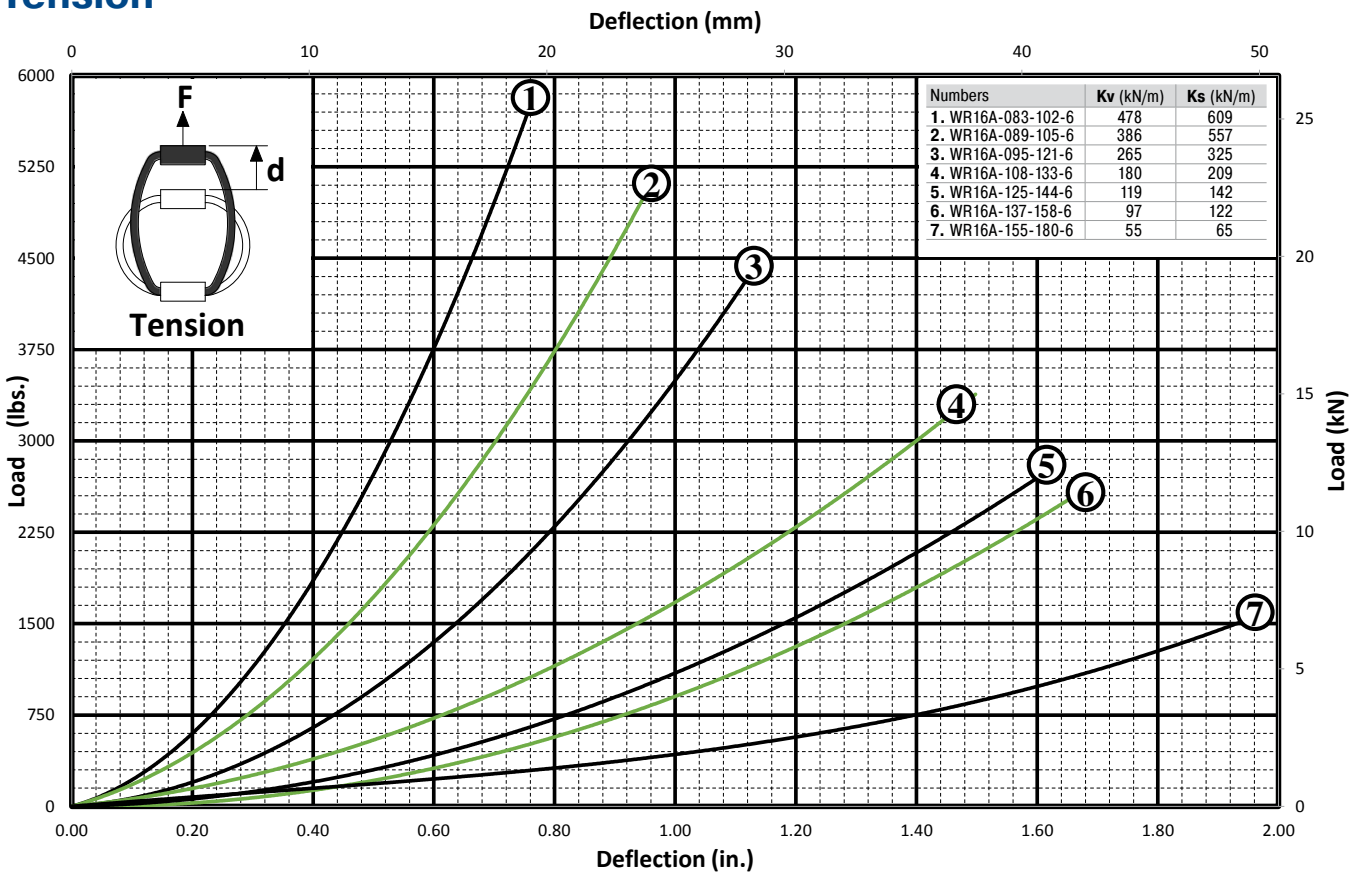

Issue 07.2020 – Specifications subject to change



### Shear

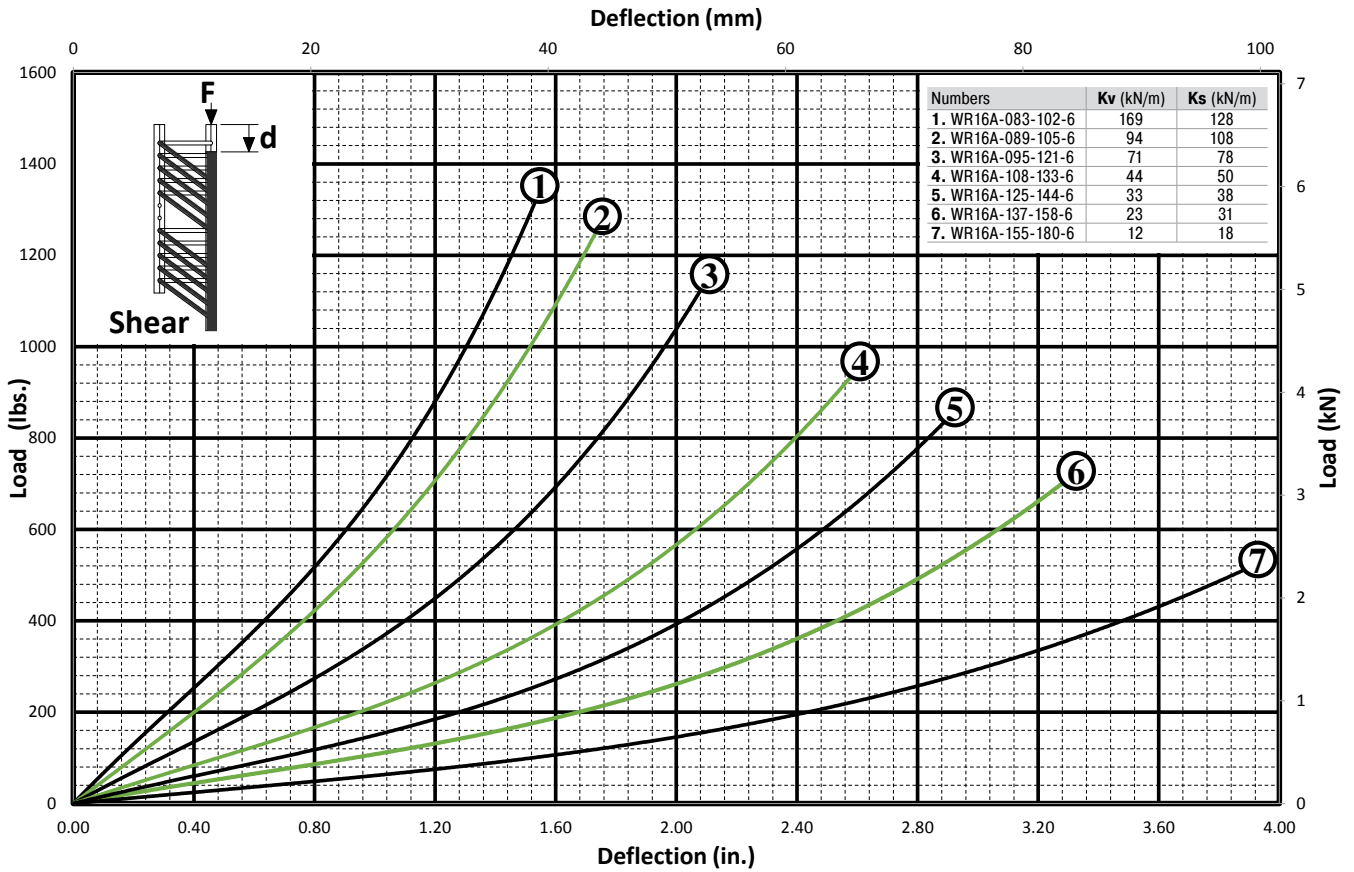

### Roll

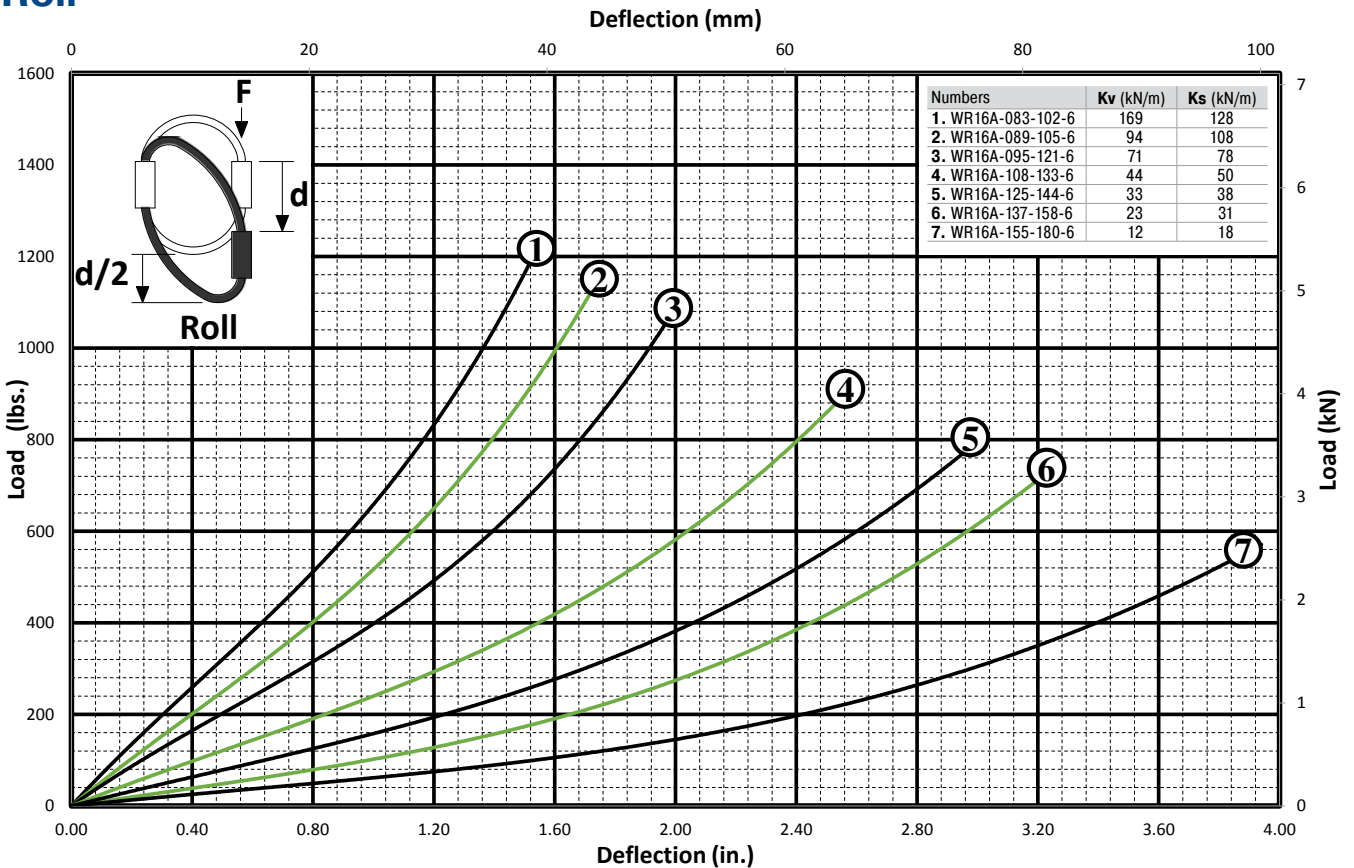

### 45° Compression/Roll

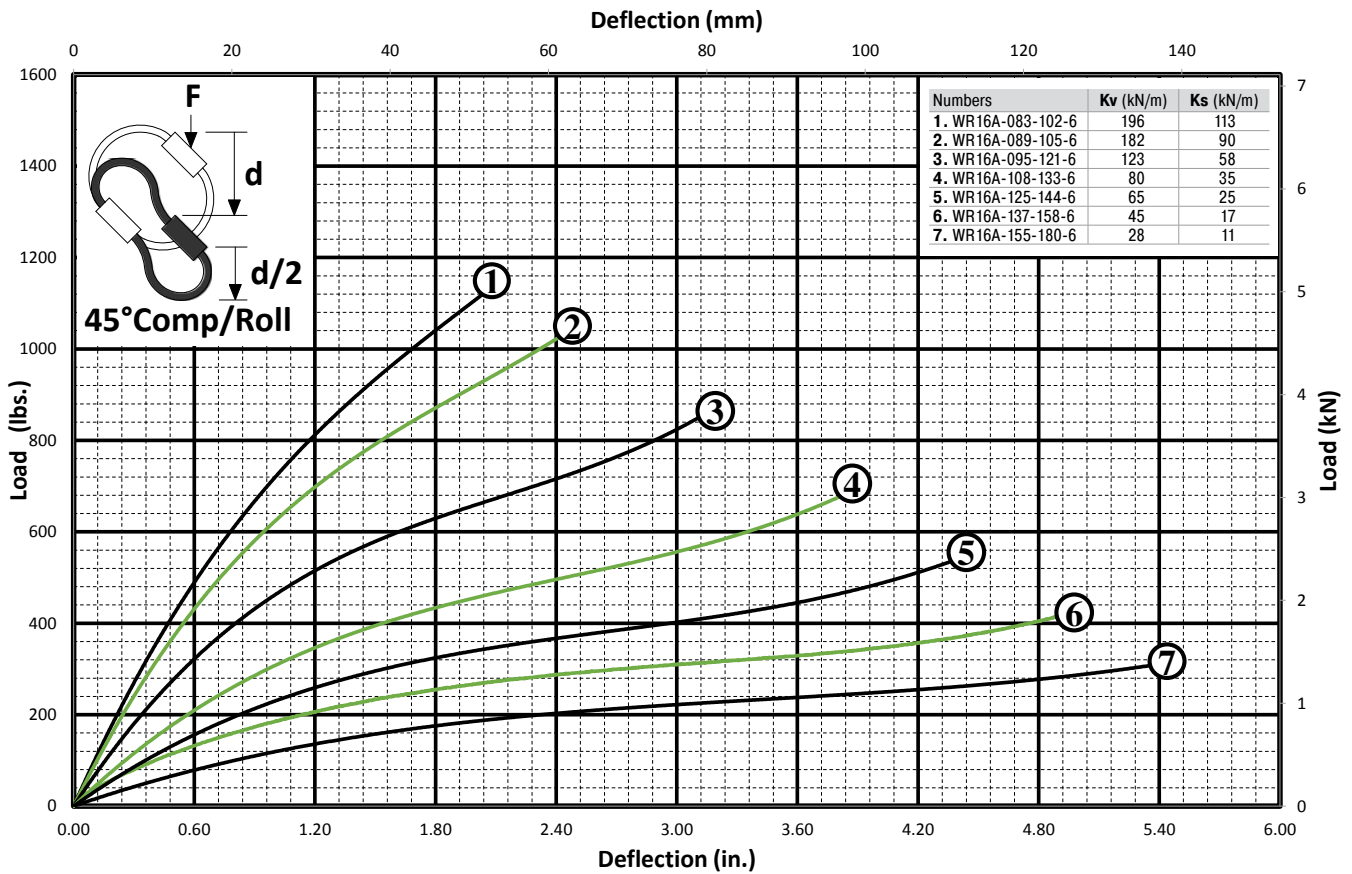

### 45° Tension/Roll

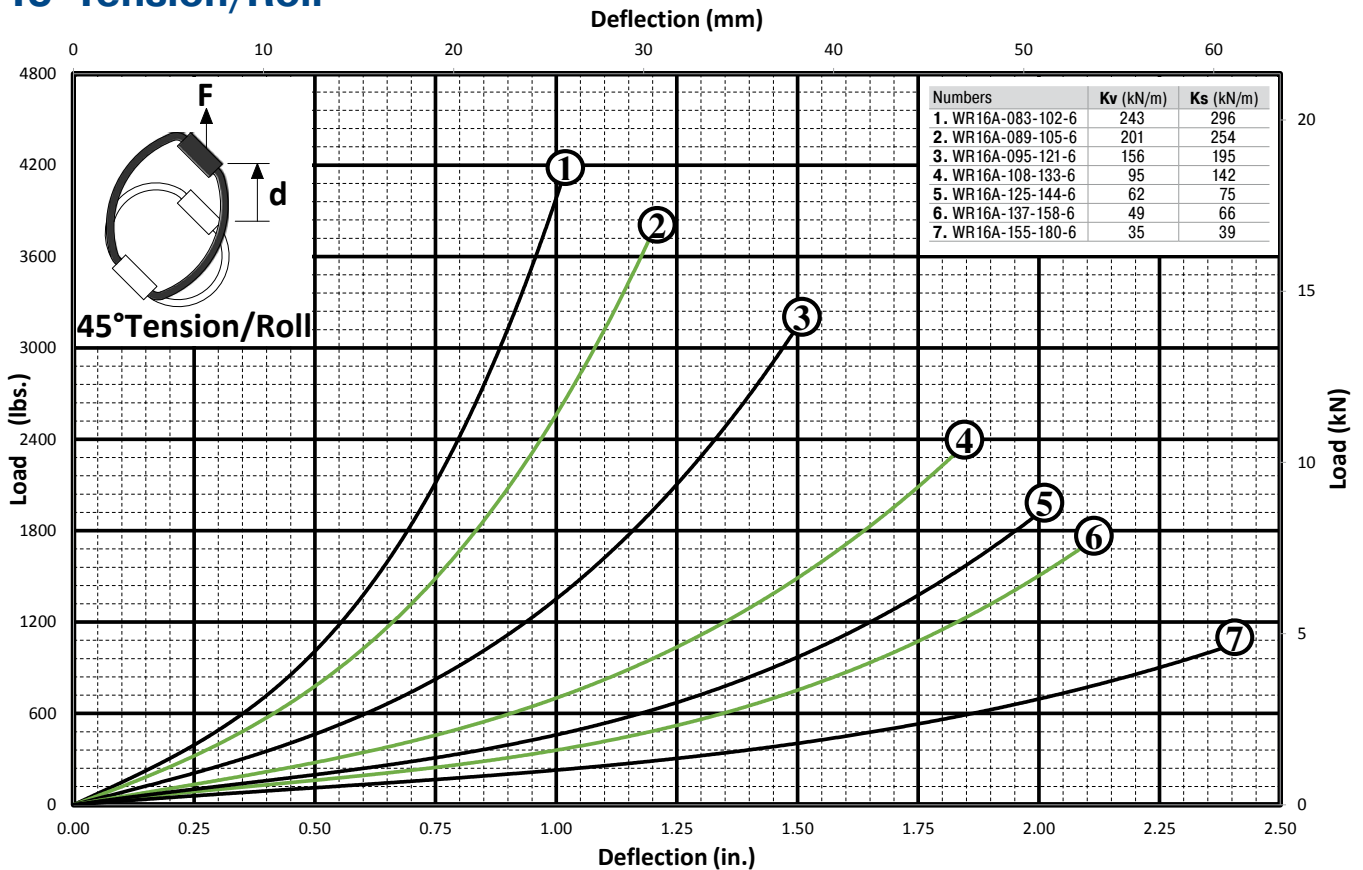

Product also available in stainless steel



# WR16

## Helical Isolator

12.70 mm (1/2") Diameter Cable



### Features

- Rugged all metal construction
- Fail safe construction
- Long life and maintenance free
- Three axis capability (6 dof)
- High damping: C/cc ≈ 0.15 to 0.20

### Operating temperature range

-130°C to +260°C

### Material

- Cable: 300 Series SS per MIL-W-83420 or RR-W-410
- Screws: 300 Series SS passivated IAW ASTM A967
- Inserts: 300 Series SS (Alum bars only)
- Retainer bars: Standard: 6061-T6 Alum alloy/ Chem film IAW MIL-DTL-5541, TYPE II, Class 3

### Note

- Mounting hole tolerances: ±0.25 mm
- Add 0.64 kg to Isolator weight for all stainless steel versions

### On request

- Special materials, size, mounting holes, finish, etc. available

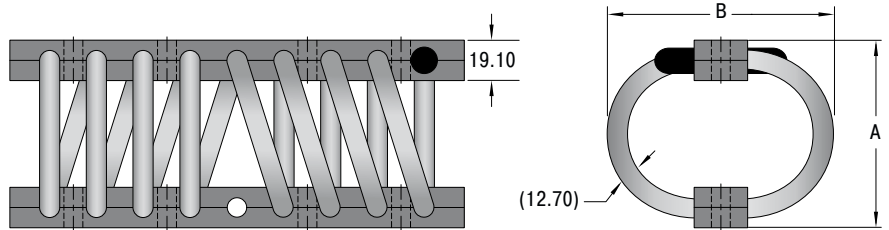
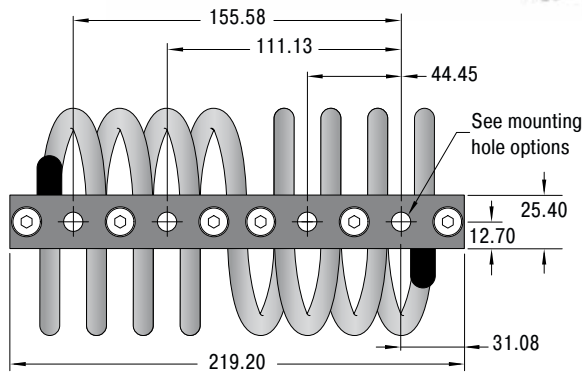

TYPEN	A (+/- 0.8) mm	B mm	Compression			Shear/Roll (Average)			Weight kg
			Kv (Vibe) kN/m	Ks (Shock) kN/m	Deflection max. mm	Kv (Vibe) kN/m	Ks (Shock) kN/m	Deflection max. mm	
WR16-083-102-8	82.6	101.9	436	294	35.6	226	171	35.6	1.680
WR16-089-105-8	88.9	104.9	413	262	41.9	126	143	41.9	1.690
WR16-095-121-8	95.3	120.7	308	183	48.3	95	104	48.3	1.860
WR16-108-133-8	108.0	133.4	191	115	61.0	58	67	61.0	2.090
WR16-125-144-8	124.5	143.5	136	80	77.5	44	51	77.5	2.270
WR16-137-158-8	137.2	157.7	96	61	90.2	30	41	90.2	2.460
WR16-155-180-8	154.9	180.3	70	39	108.0	17	25	108.0	2.790

### Ordering Example

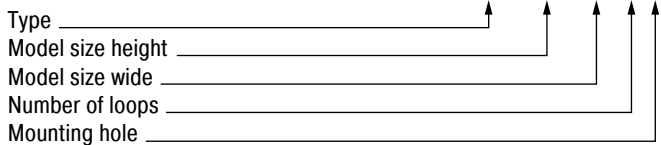

Mounting Hole Options	
<p>A</p>	<p>D</p>
<p>B</p>	<p>E</p>
<p>C</p>	<p>F</p>

Issue 07.2020 – Specifications subject to change

### Compression

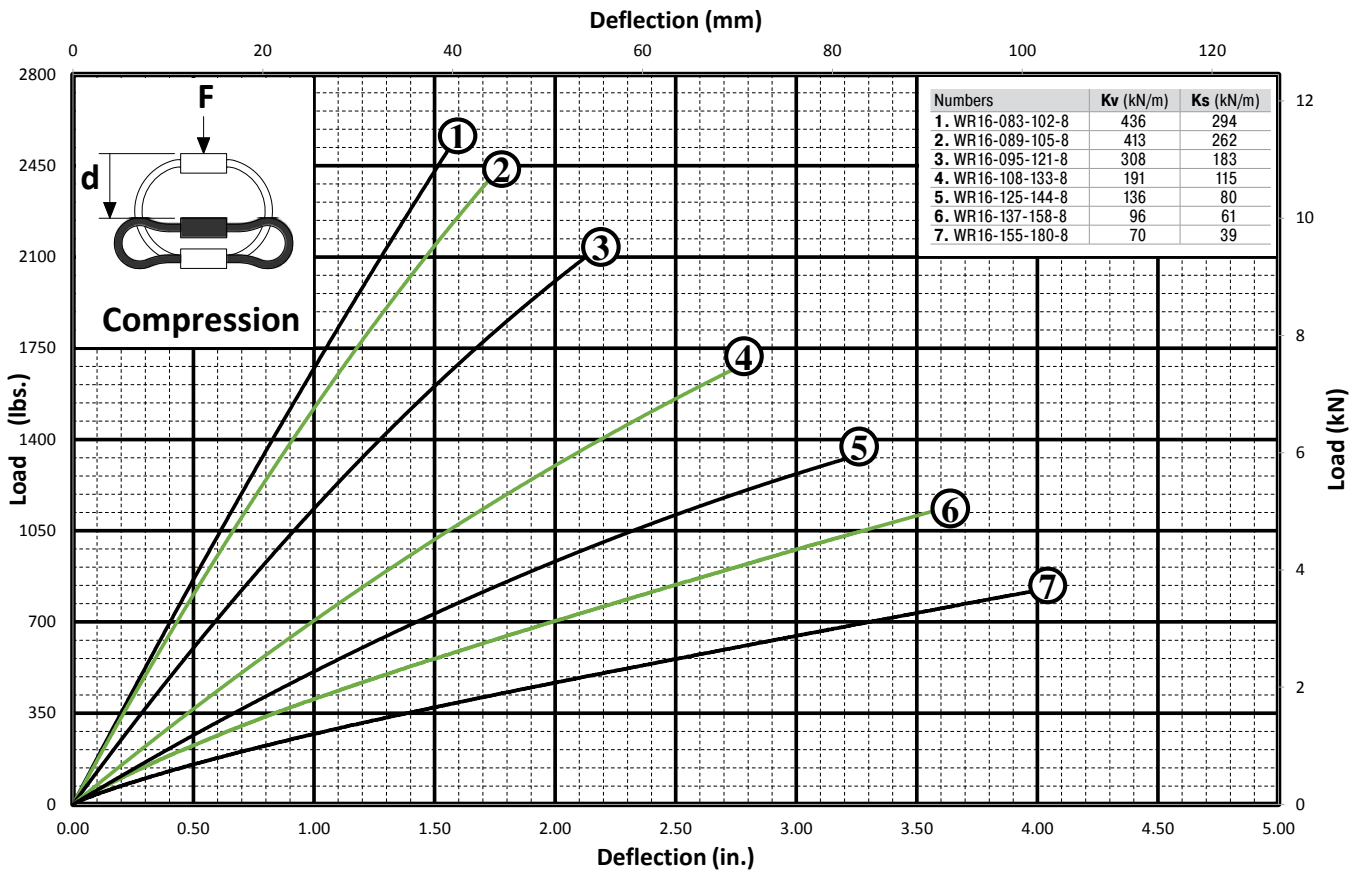

### Tension

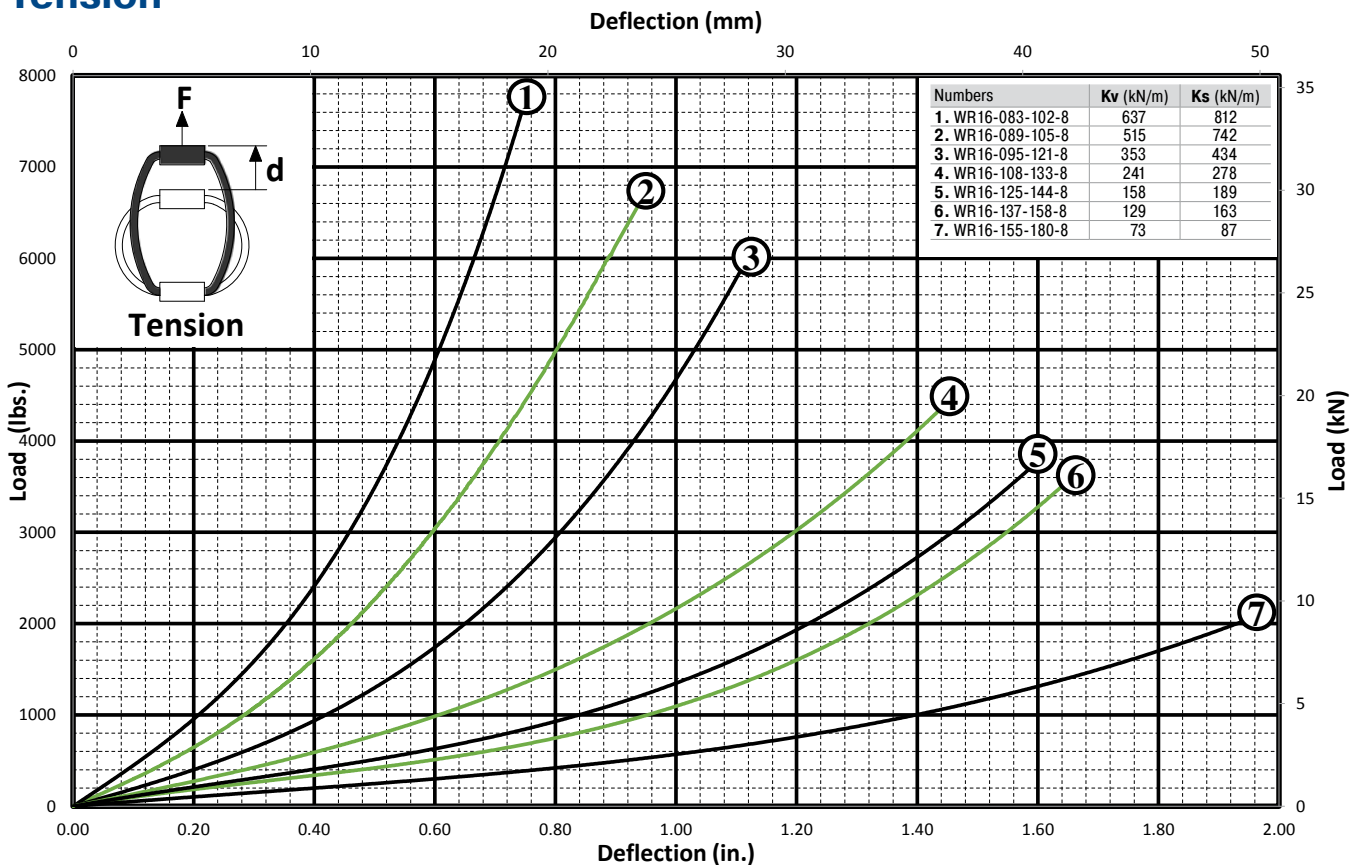

Issue 07.2020 – Specifications subject to change

### Shear

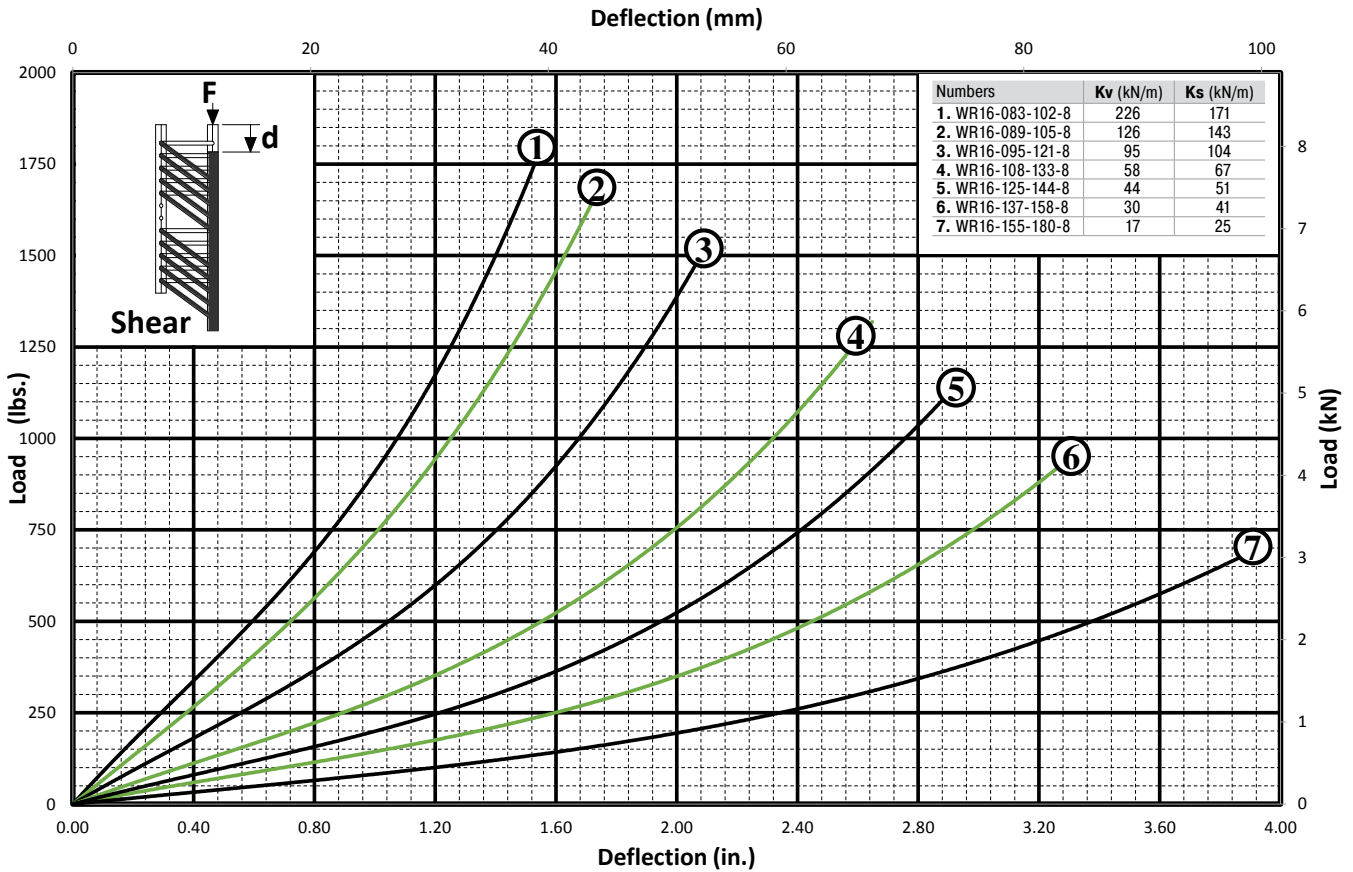

### Roll

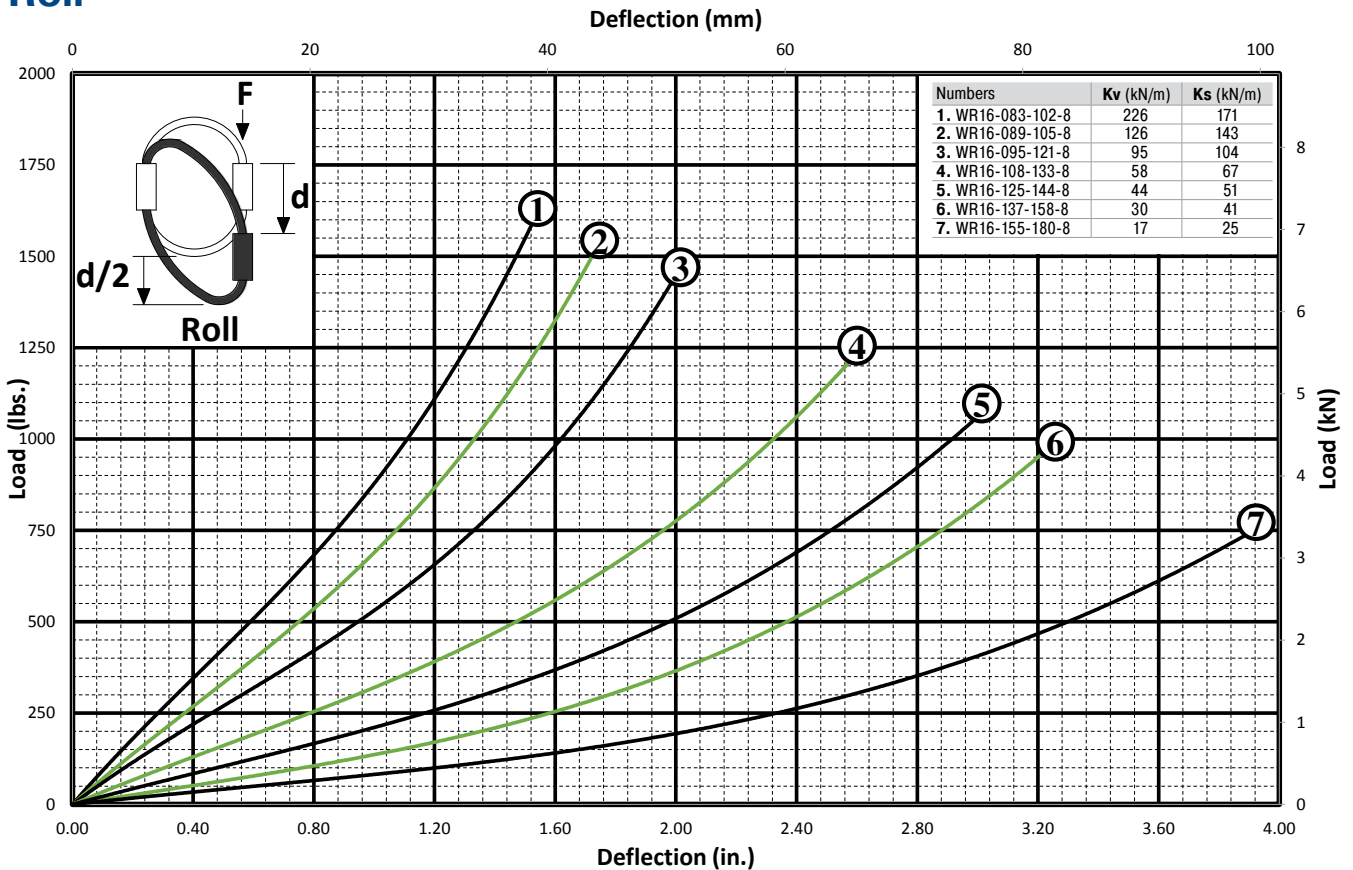



### 45° Compression/Roll

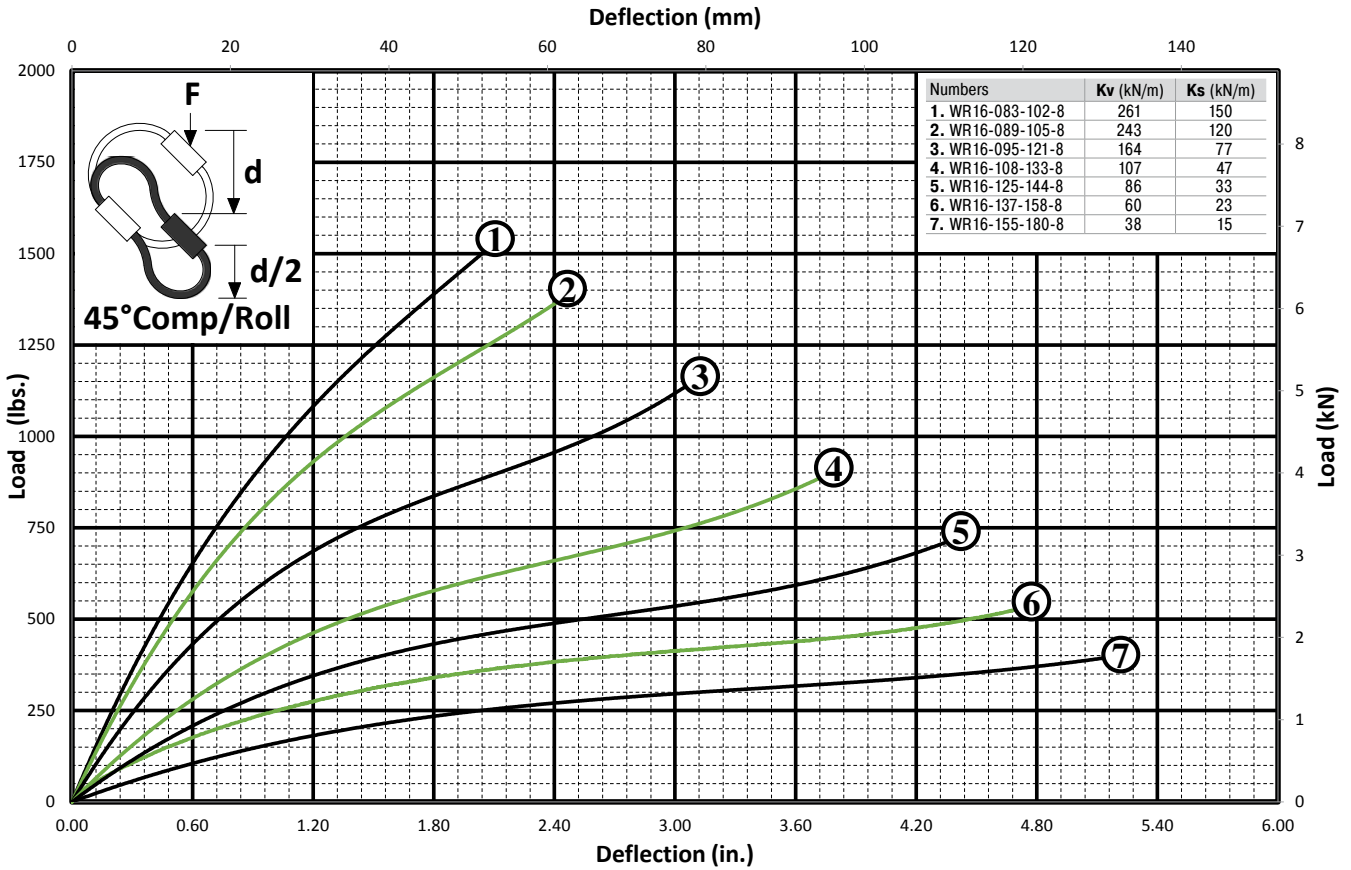

### 45° Tension/Roll

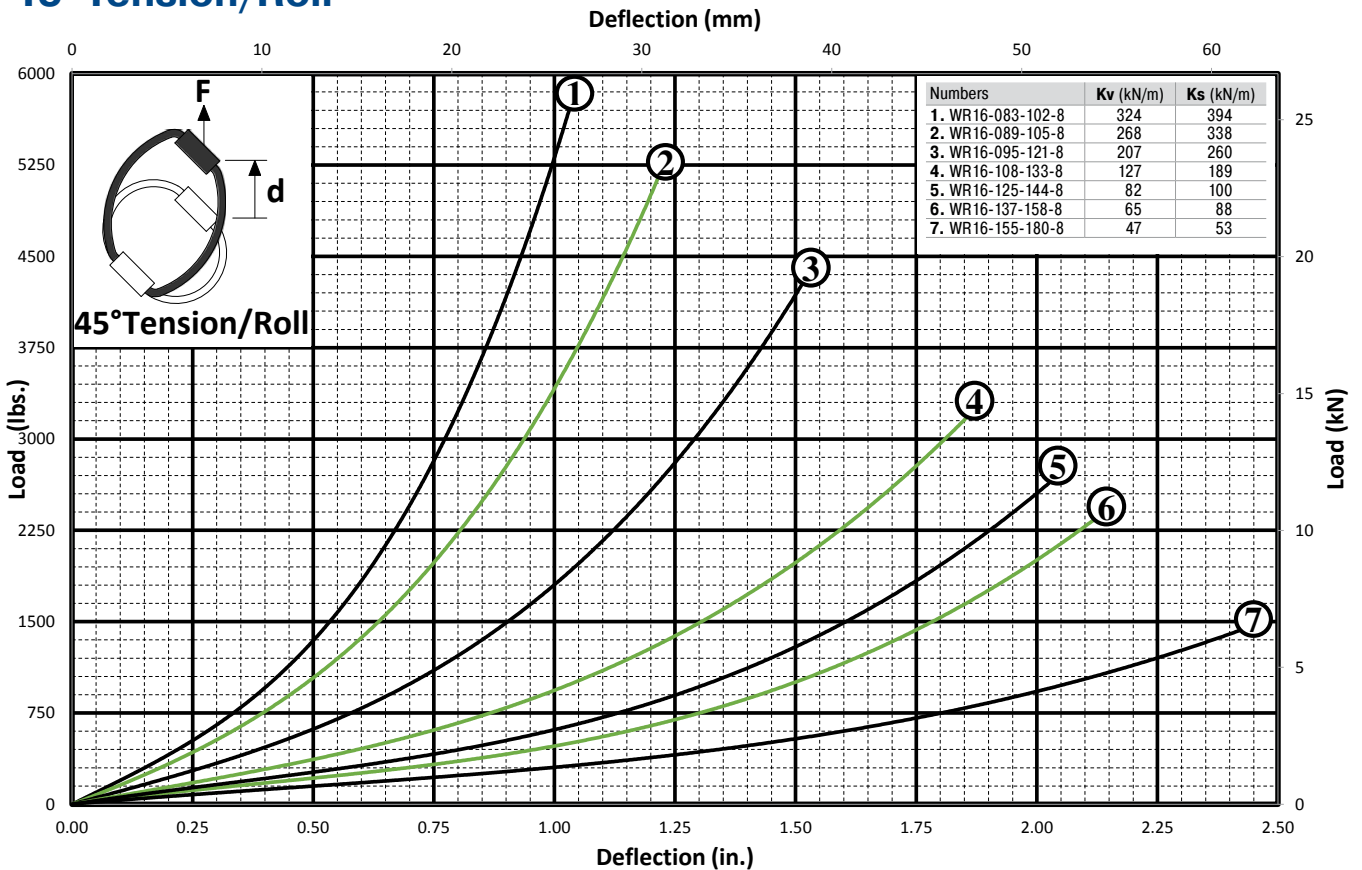

Product also available in stainless steel



# WR20

## Helical Isolator

15.88 mm (5/8") Diameter Cable



### Features

- Rugged all metal construction
- Fail safe construction
- Long life and maintenance free
- Three axis capability (6 dof)
- High damping: C/cc ≈ 0.15 to 0.20

### Operating temperature range

-130°C to +260°C

### Material

- Cable: 300 Series SS per MIL-W-83420 or RR-W-410
- Screws: 300 Series SS passivated IAW ASTM A967
- Inserts: 300 Series SS (Alum bars only)
- Retainer bars: Standard: 6061-T6 Alum alloy/ Chem film IAW MIL-DTL-5541, TYPE II, Class 3

### Note

- Mounting hole tolerances: ±0.25 mm
- Add 1.02 kg to Isolator weight for all stainless steel versions

### On request

Special materials, size, mounting holes, finish, etc. available

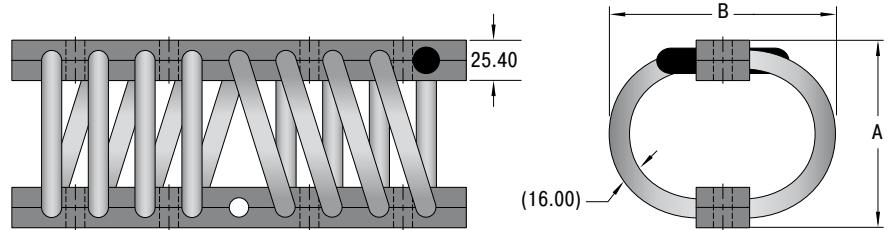
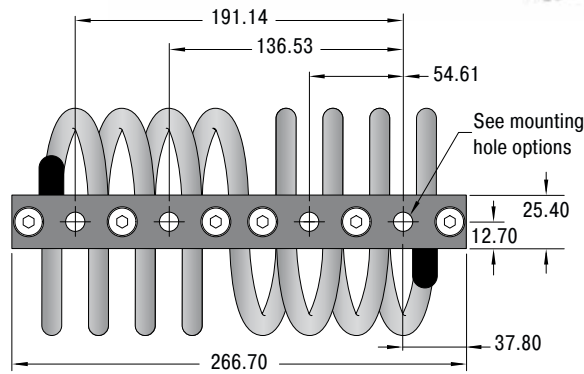

### Performance

TYPEN	A (+/- 0.8) mm	B mm	Compression			Shear/Roll (Average)			Weight kg
			Kv (Vibe) kN/m	Ks (Shock) kN/m	Deflection max. mm	Kv (Vibe) kN/m	Ks (Shock) kN/m	Deflection max. mm	
WR20-089-102-8	88.9	101.6	1,228	613	30.5	378	307	30.5	2.880
WR20-099-112-8	99.1	111.8	992	476	40.6	258	238	40.6	2.950
WR20-109-135-8	109.2	134.6	787	308	50.8	167	158	50.8	3.180
WR20-119-153-8	119.4	152.6	444	204	61.0	103	106	61.0	3.740
WR20-127-165-8	127.0	165.1	355	161	68.6	98	87	68.6	3.970
WR20-135-178-8	134.6	177.8	322	124	76.2	70	71	76.2	4.220
WR20-152-197-8	152.4	196.8	262	87	94.0	44	48	94.0	4.630

### Ordering Example

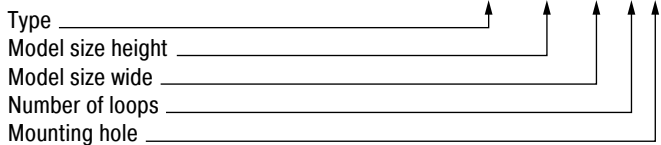

### Mounting Hole Options

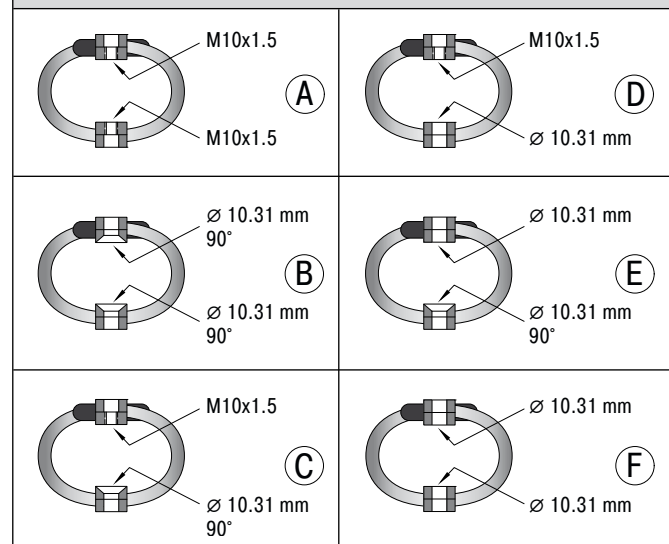

Issue 07.2020 – Specifications subject to change

### Compression

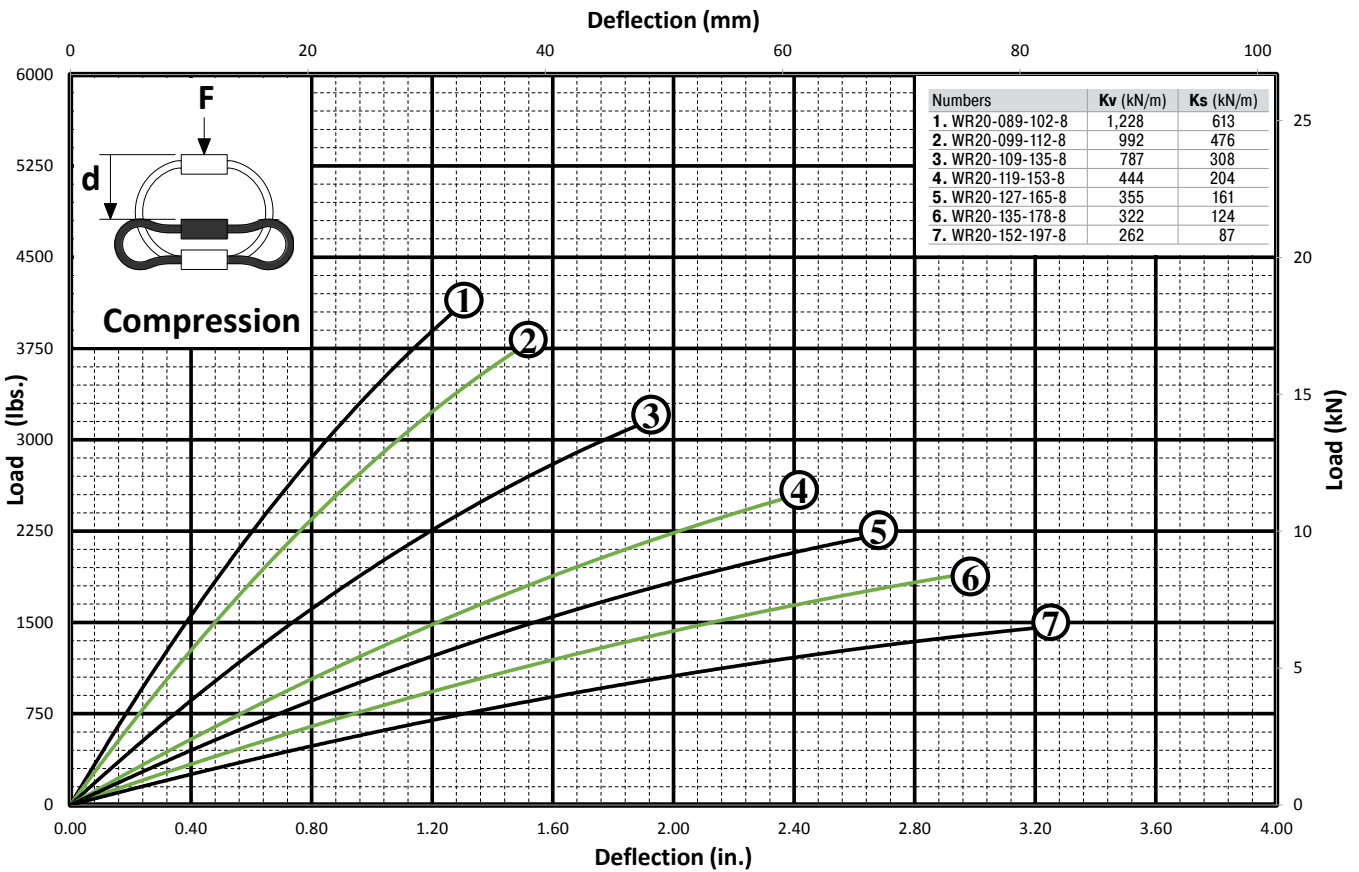

### Tension

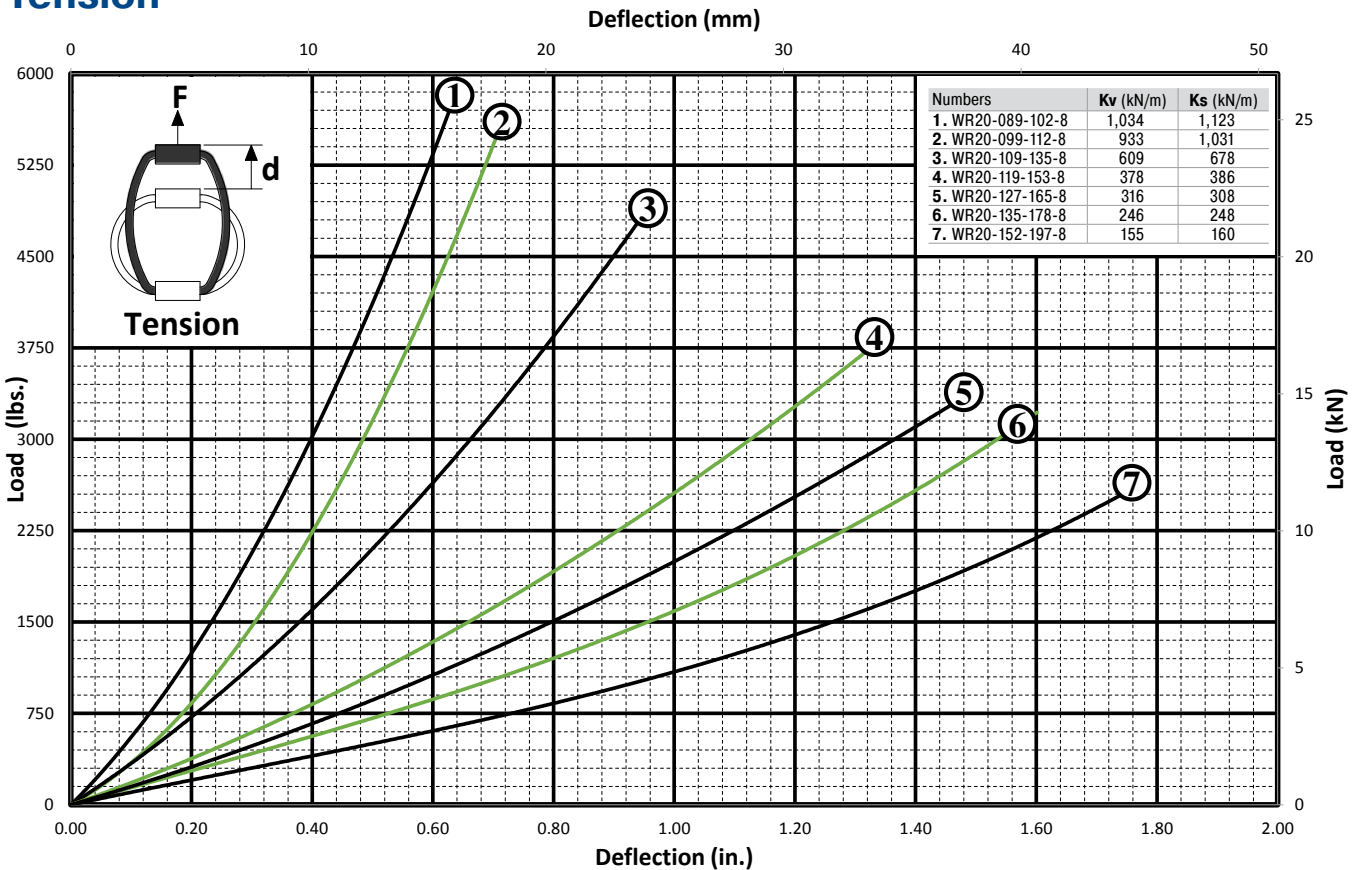

Issue 07.2020 – Specifications subject to change

### Shear

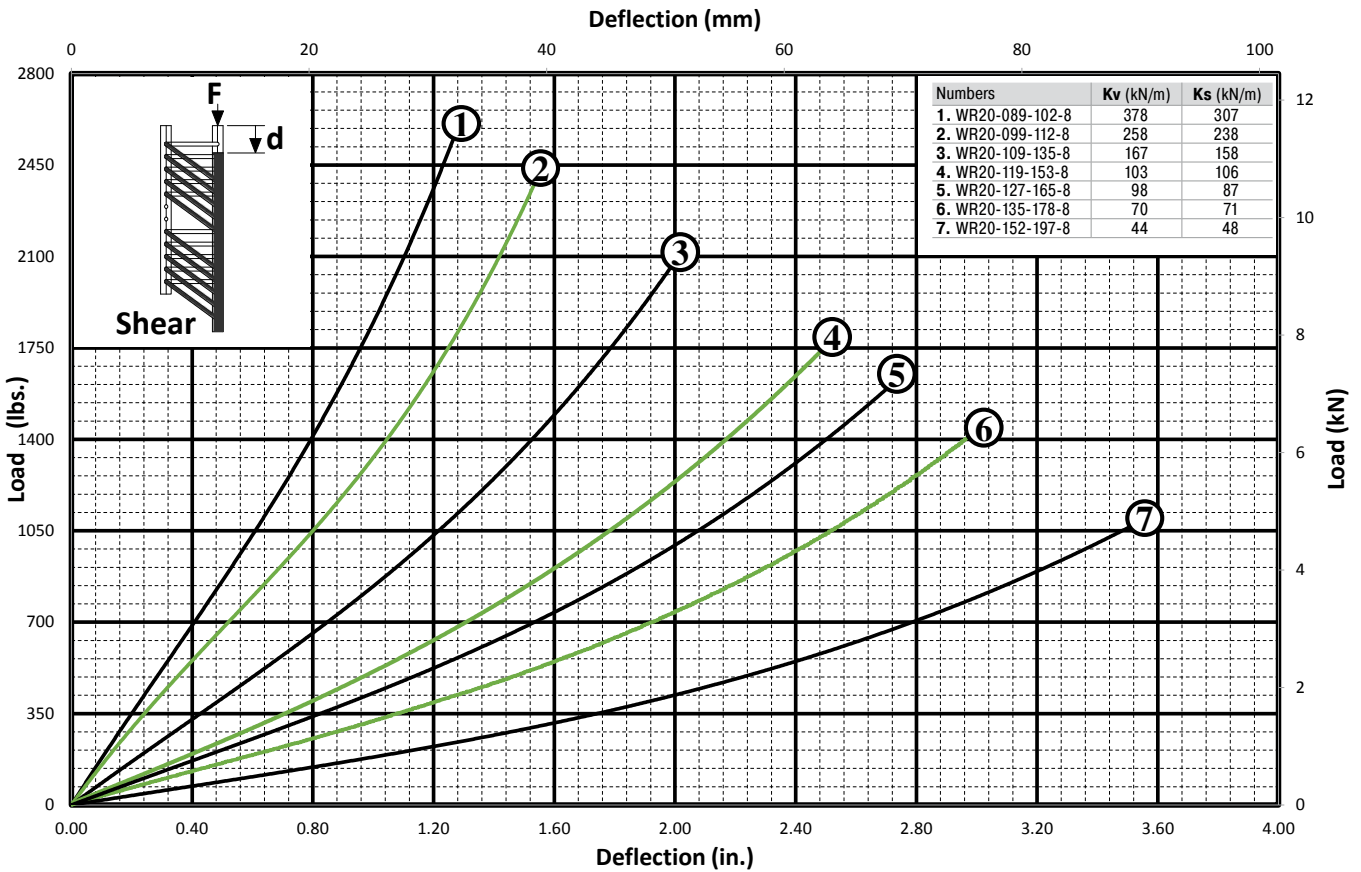

### Roll

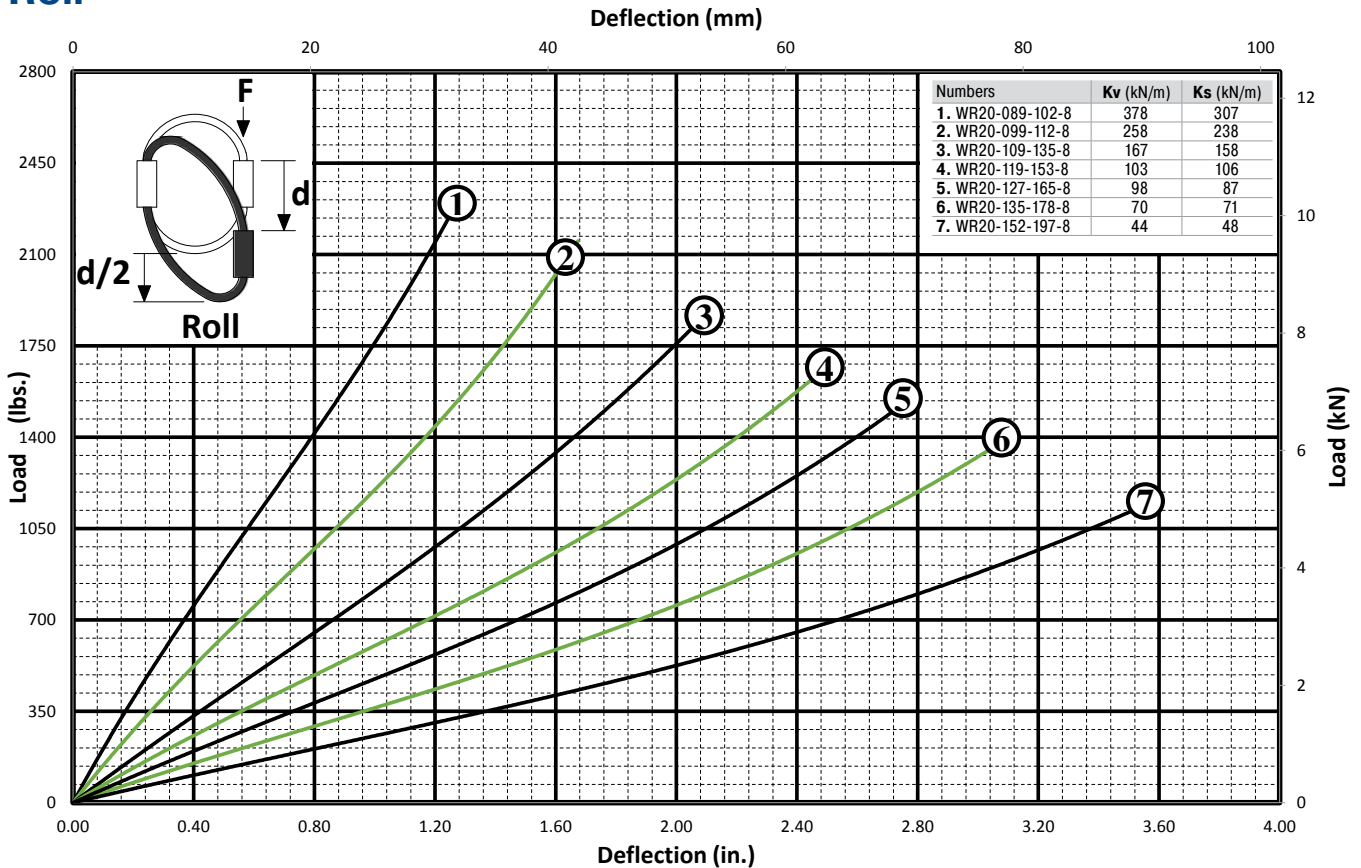

### 45° Compression/Roll

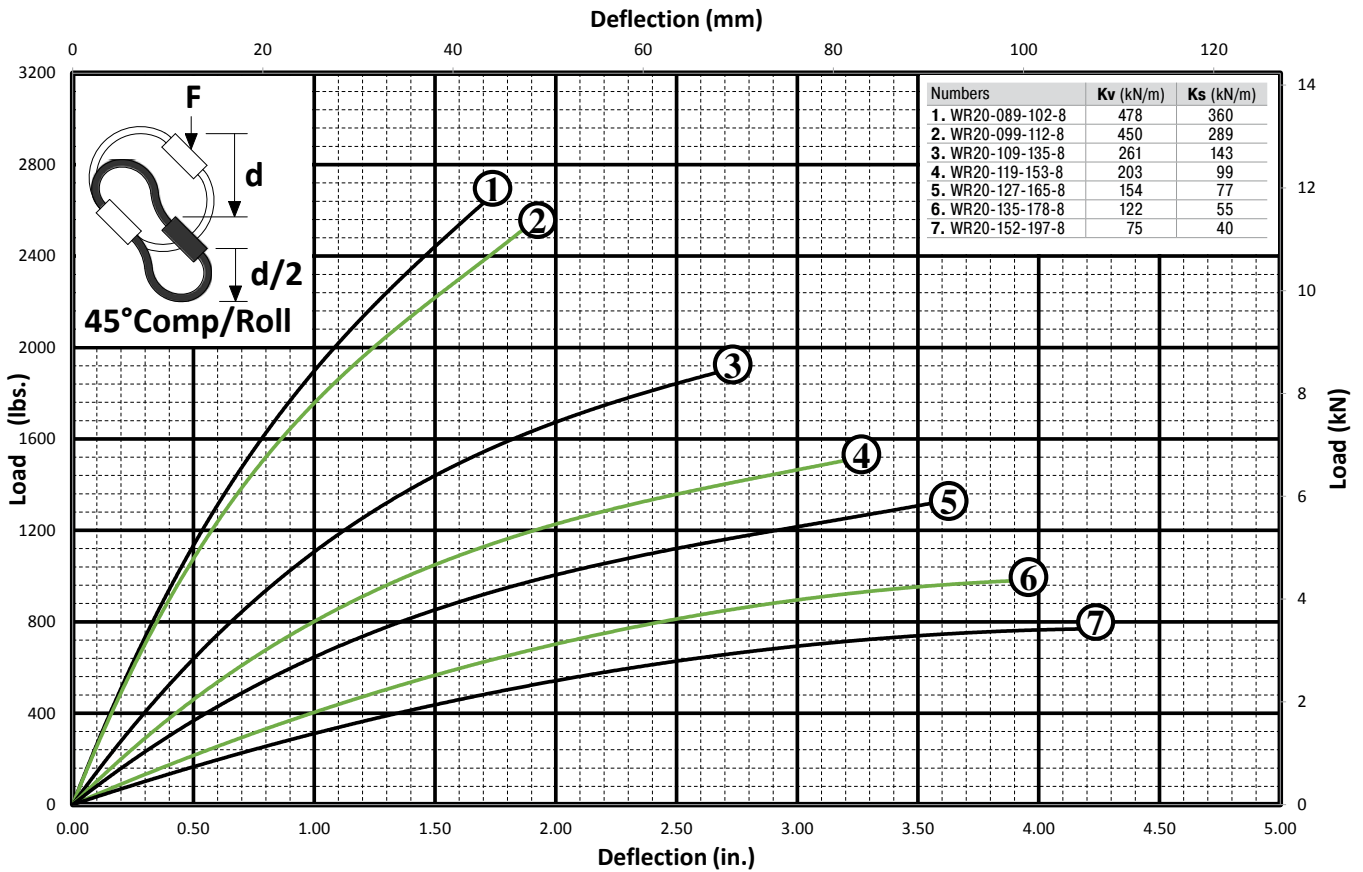

### 45° Tension/Roll

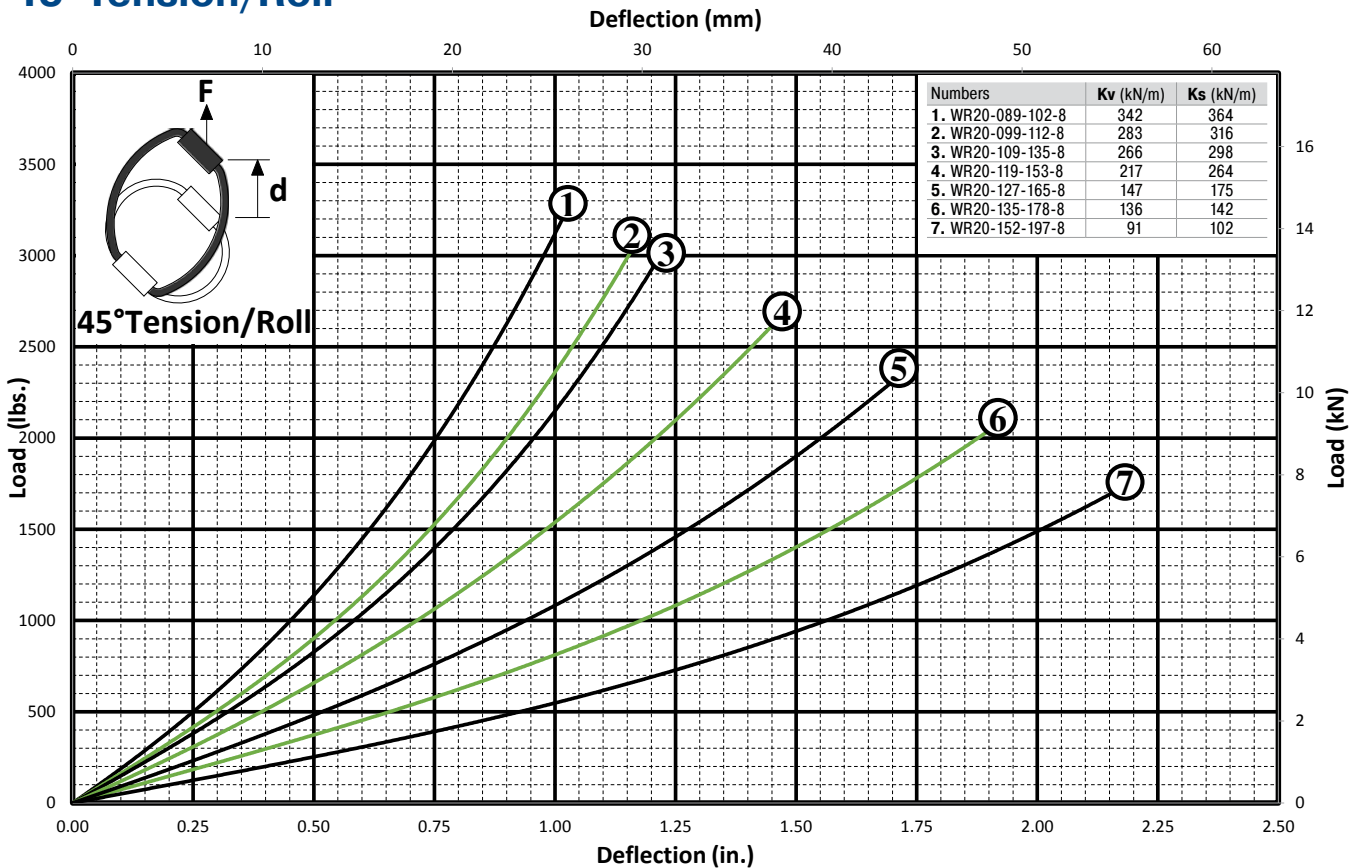

Issue 07.2020 – Specifications subject to change



Product also available in stainless steel



# WR24

## Helical Isolator

19.05 mm (3/4") Diameter Cable



### Features

- Rugged all metal construction
- Fail safe construction
- Long life and maintenance free
- Three axis capability (6 dof)
- High damping: C/cc ≈ 0.15 to 0.20

### Operating temperature range

-130°C to +260°C

### Material

- Cable: 300 Series SS per MIL-W-83420 or RR-W-410
- Screws: 300 Series SS passivated IAW ASTM A967
- Inserts: 300 Series SS (Alum bars only)
- Retainer bars: Standard: 6061-T6 Alum alloy/ Chem film IAW MIL-DTL-5541, TYPE II, Class 3

### Note

- Mounting hole tolerances: ±0.25 mm
- Add 1.53 kg to Isolator weight for all stainless steel versions

### On request

Special materials, size, mounting holes, finish, etc. available

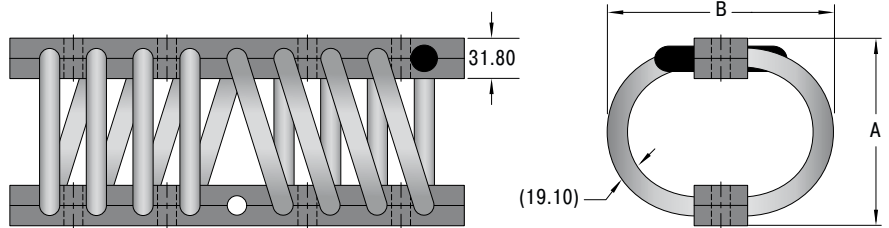
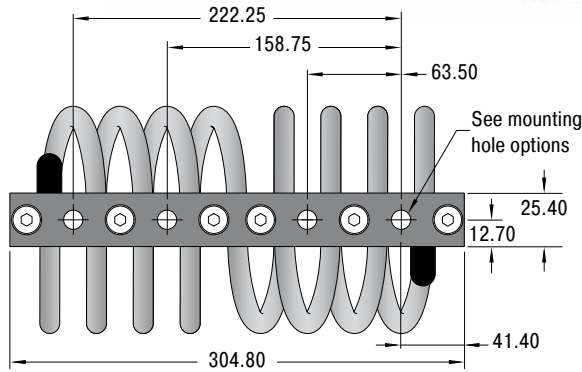

### Performance

TYPEN	A (+/- 0.8) mm	B mm	Compression			Shear/Roll (Average)			Weight kg
			Kv (Vibe) kN/m	Ks (Shock) kN/m	Deflection max. mm	Kv (Vibe) kN/m	Ks (Shock) kN/m	Deflection max. mm	
WR24-102-108-8	101.6	108.0	1,099	668	30.5	420	443	30.5	4.760
WR24-112-118-8	111.8	118.1	942	644	40.6	406	381	40.6	5.060
WR24-122-140-8	121.9	139.7	807	452	50.8	306	257	50.8	5.450
WR24-131-159-8	131.1	158.8	709	367	61.0	212	199	61.0	5.740
WR24-140-172-8	139.7	171.5	588	311	68.6	178	188	68.6	5.930
WR24-152-210-8	152.4	209.6	422	235	81.3	134	143	81.3	6.210

### Ordering Example

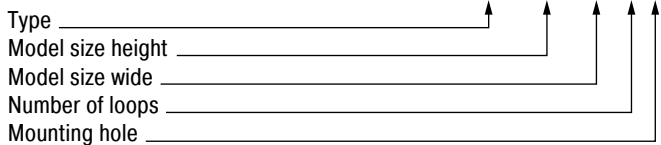

Mounting Hole Options	
<p>A</p>	<p>D</p>
<p>B</p>	<p>E</p>
<p>C</p>	<p>F</p>

Issue 07.2020 – Specifications subject to change

### Compression

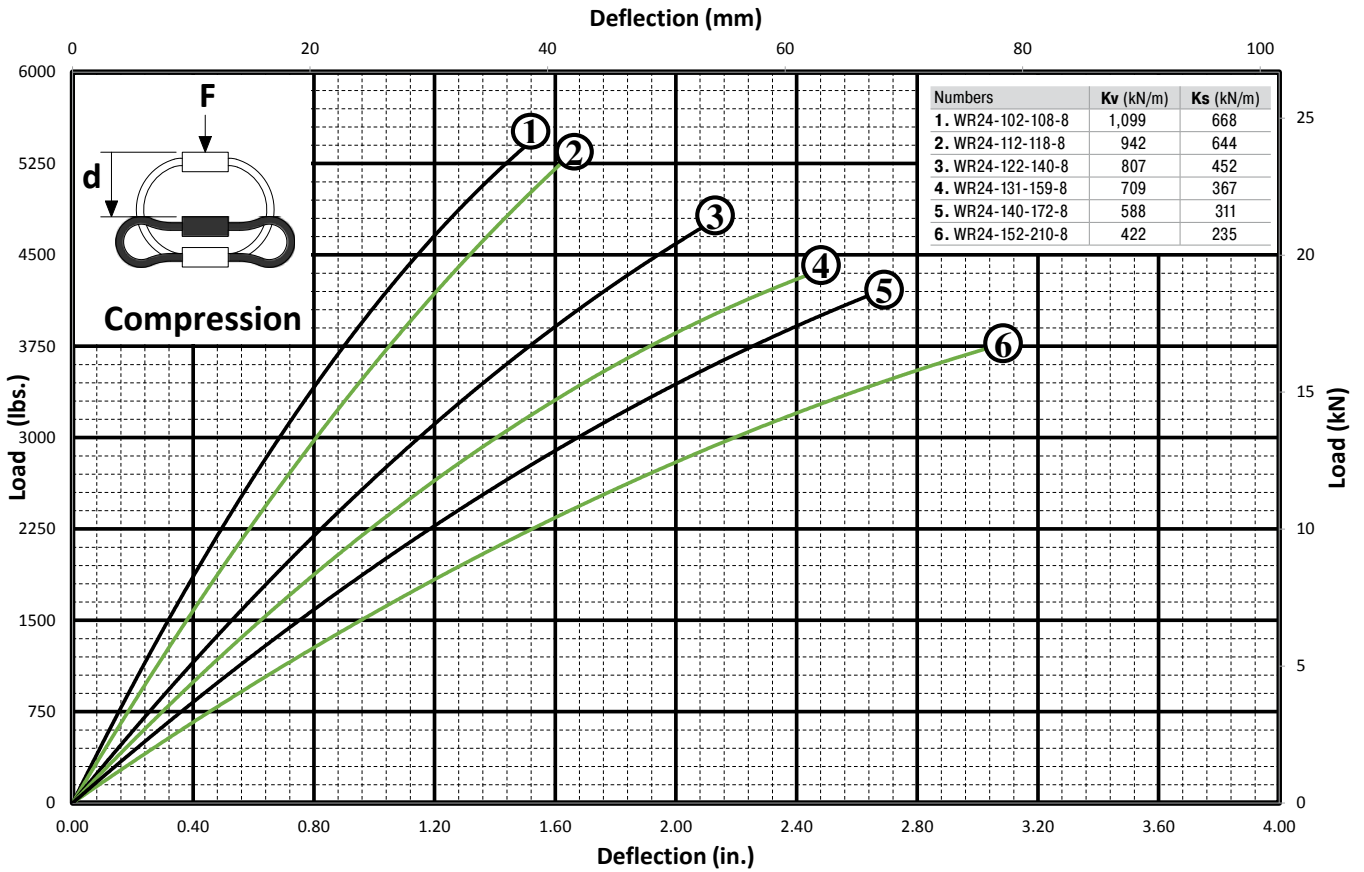

### Tension

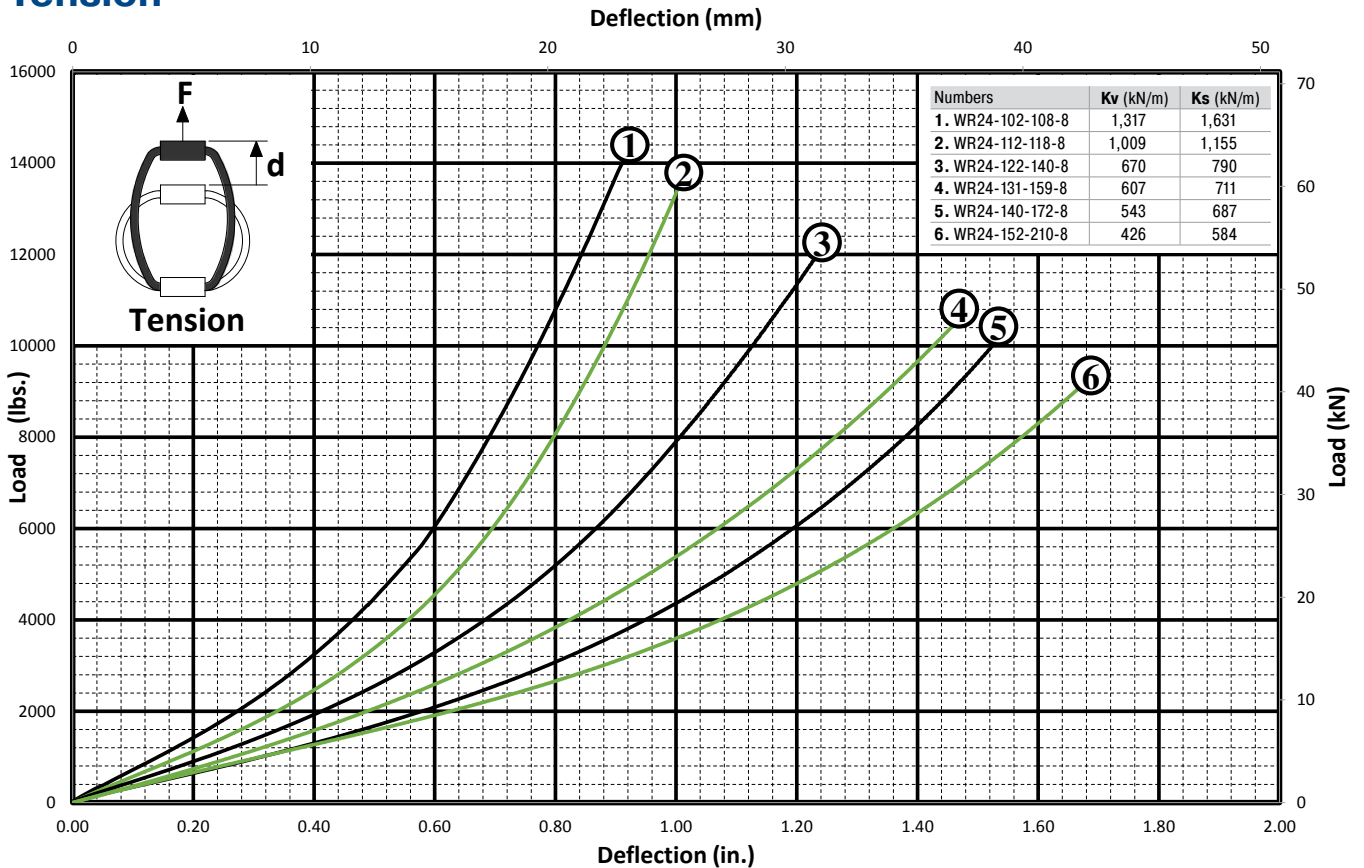

Issue 07.2020 – Specifications subject to change

### Shear

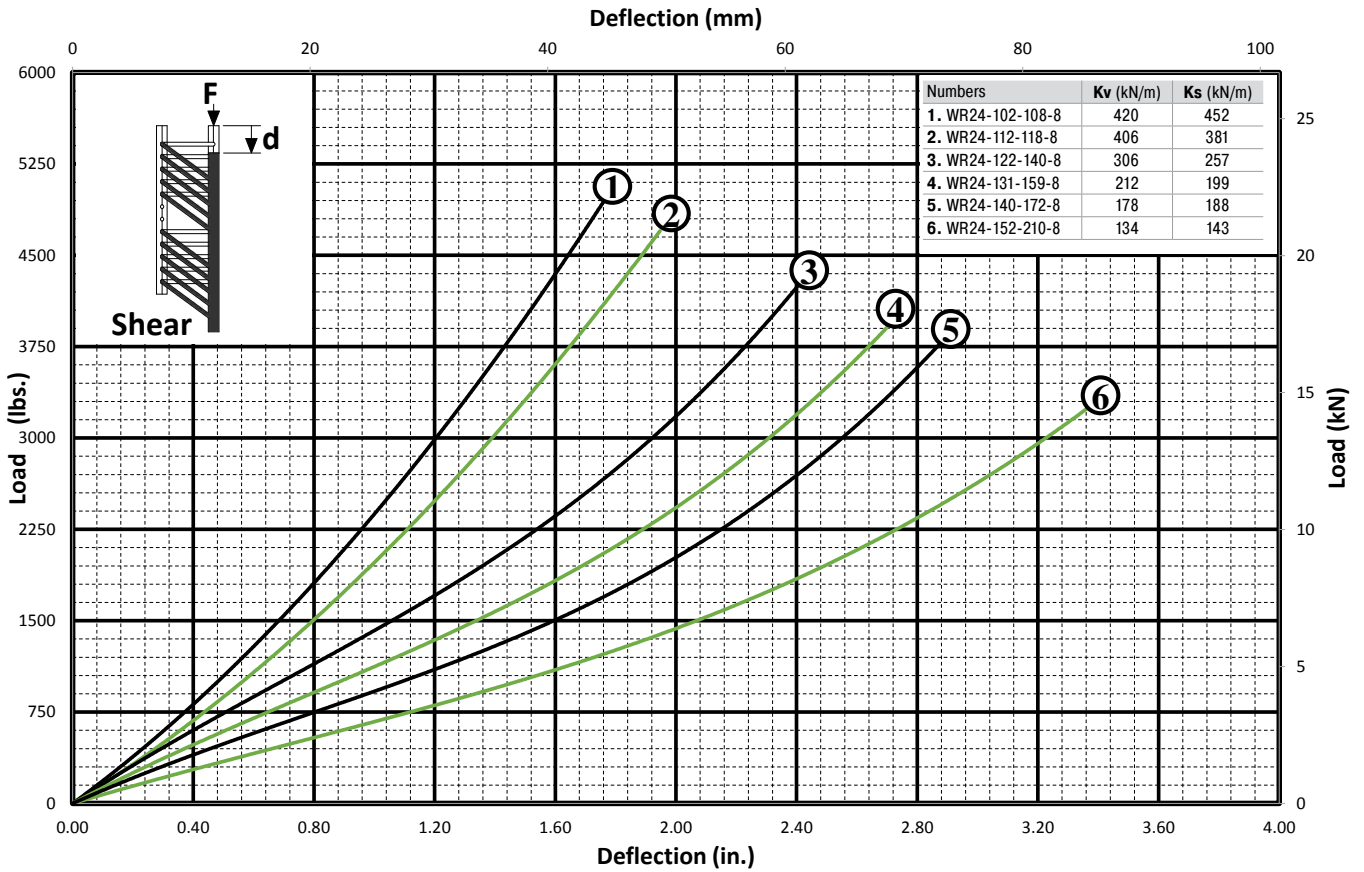

### Roll

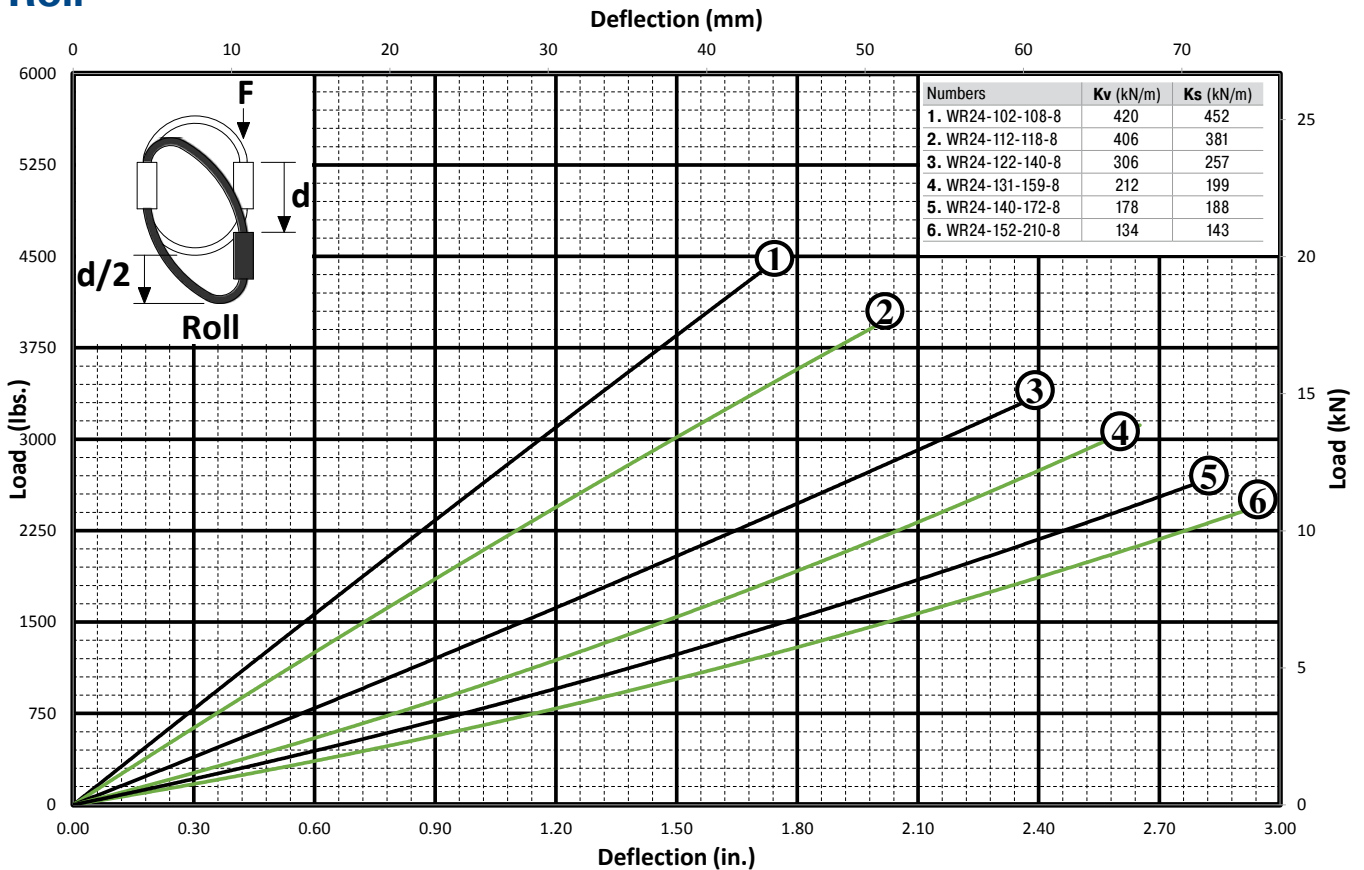

### 45° Compression/Roll

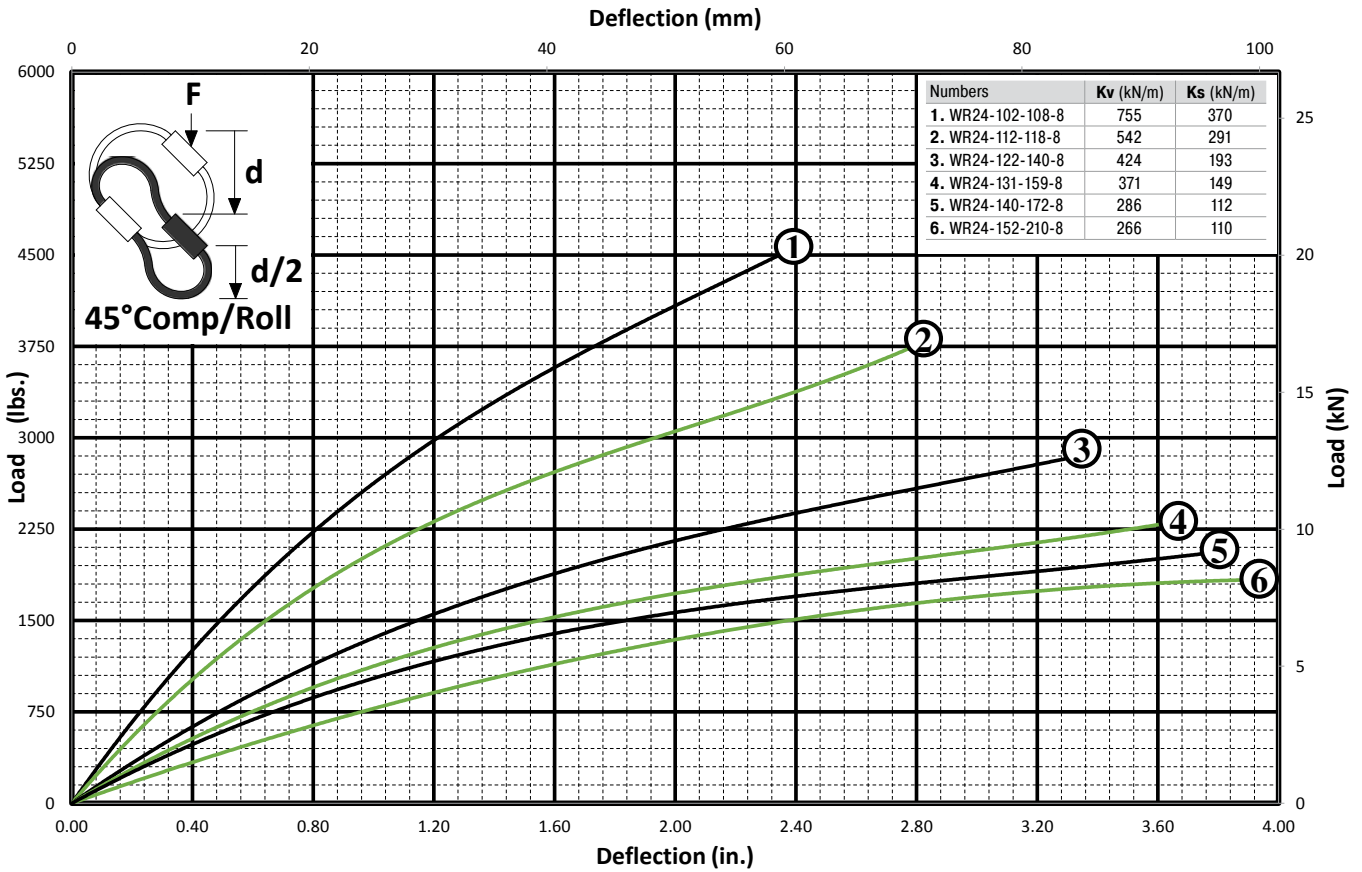

### 45° Tension/Roll

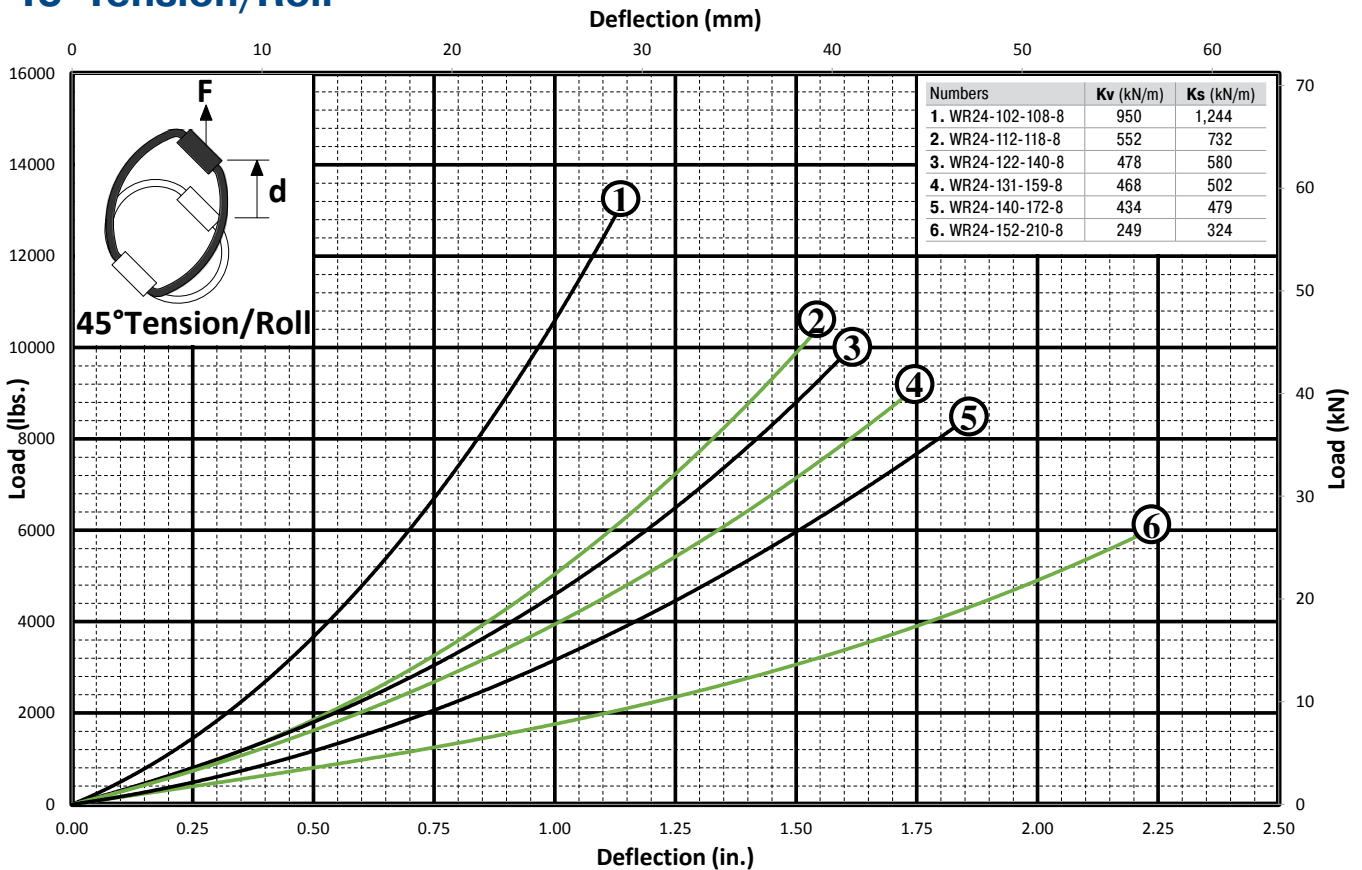

Issue 07.2020 – Specifications subject to change

Product also available in stainless steel



# WR28

## Helical Isolator

22.23 mm (7/8") Diameter Cable



### Features

- Rugged all metal construction
- Fail safe construction
- Long life and maintenance free
- Three axis capability (6 dof)
- High damping: C/cc ≈ 0.15 to 0.20

### Operating temperature range

-130°C to +260°C

### Material

- Cable: 300 Series SS per MIL-W-83420 or RR-W-410
- Screws: 300 Series SS passivated IAW ASTM A967
- Inserts: 300 Series SS (Alum bars only)
- Retainer bars: Standard: 6061-T6 Alum alloy/ Chem film IAW MIL-DTL-5541, TYPE II, Class 3

### Note

- Mounting hole tolerances: ±0.25 mm
- Add 3.50 kg to Isolator weight for all stainless steel versions

### On request

- Special materials, size, mounting holes, finish, etc. available

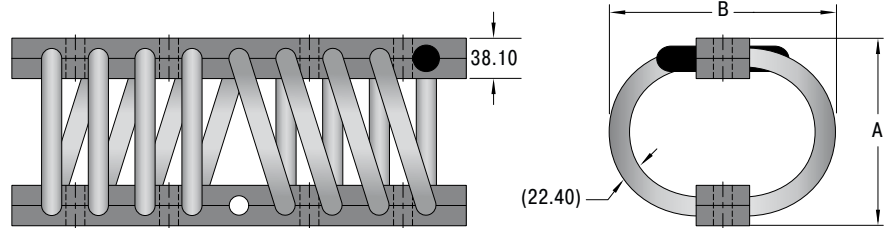
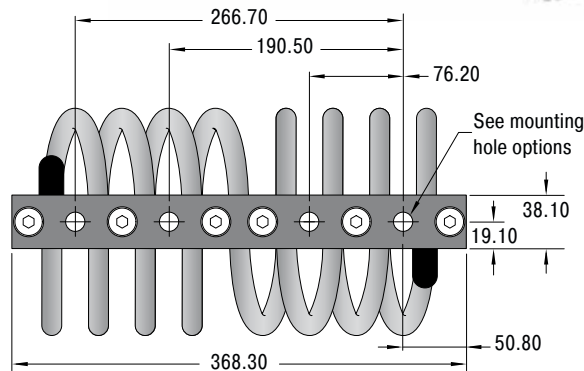

### Performance

TYPEN	A (+/- 0.8) mm	B mm	Compression			Shear/Roll (Average)			Weight kg
			Kv (Vibe) kN/m	Ks (Shock) kN/m	Deflection max. mm	Kv (Vibe) kN/m	Ks (Shock) kN/m	Deflection max. mm	
WR28-133-172-8	133.4	171.5	1,094	725	45.7	346	375	45.7	9.080
WR28-152-178-8	152.4	177.8	968	651	66.0	278	309	66.0	9.670
WR28-159-184-8	158.8	184.2	736	483	71.1	244	272	71.1	9.830
WR28-178-197-8	177.8	196.9	517	332	88.9	137	152	88.9	10.830
WR28-191-210-8	190.5	209.6	444	238	101.6	116	128	101.6	11.400
WR28-216-235-8	215.9	235.0	323	155	127.0	82	88	127.0	12.200

### Ordering Example

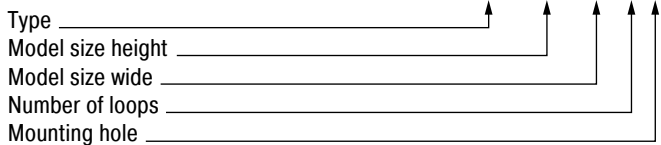

Mounting Hole Options	
<p>A</p>	<p>D</p>
<p>B</p>	<p>E</p>
<p>C</p>	<p>F</p>

Issue 07.2020 – Specifications subject to change



### Compression

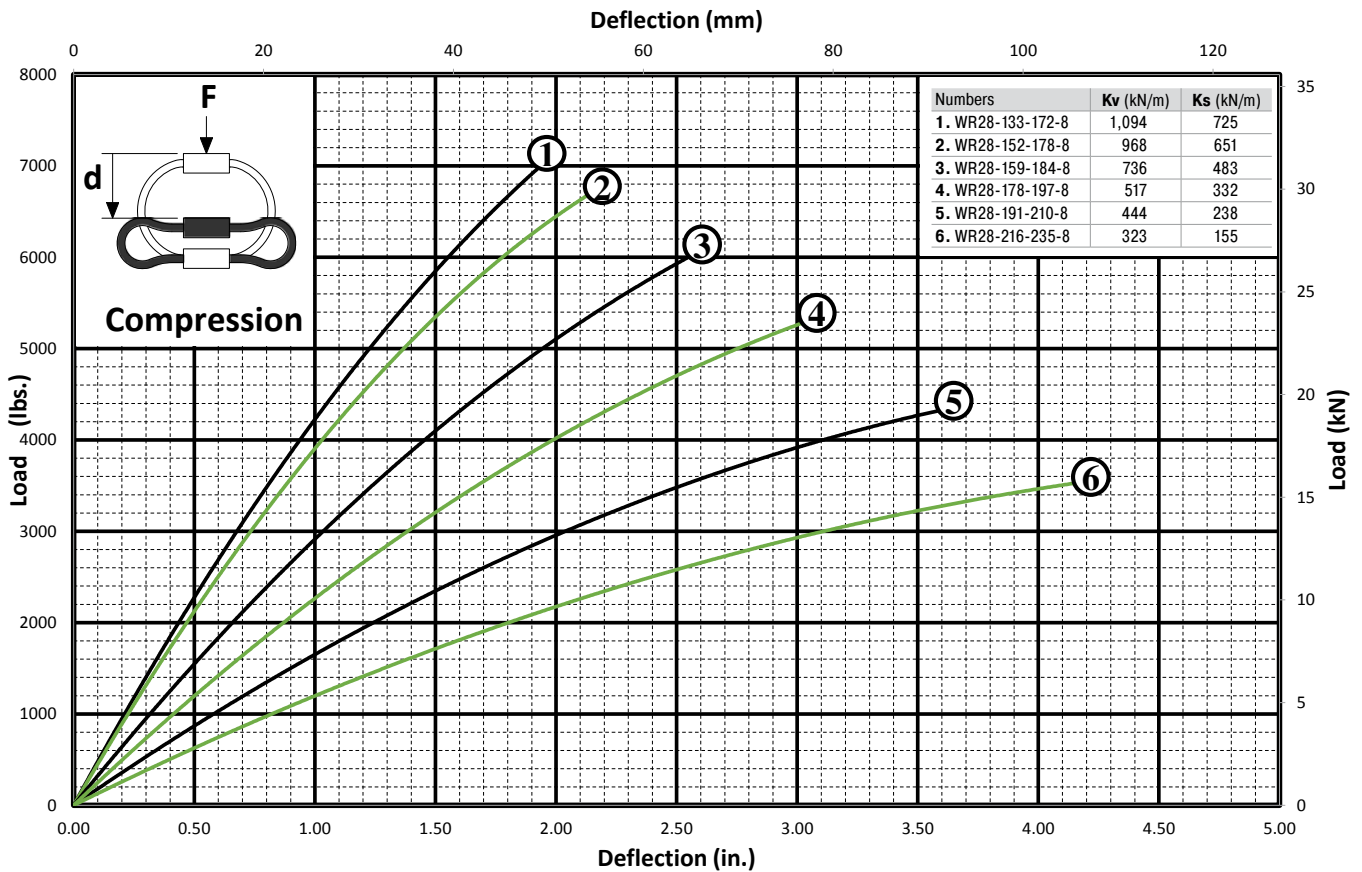

### Tension

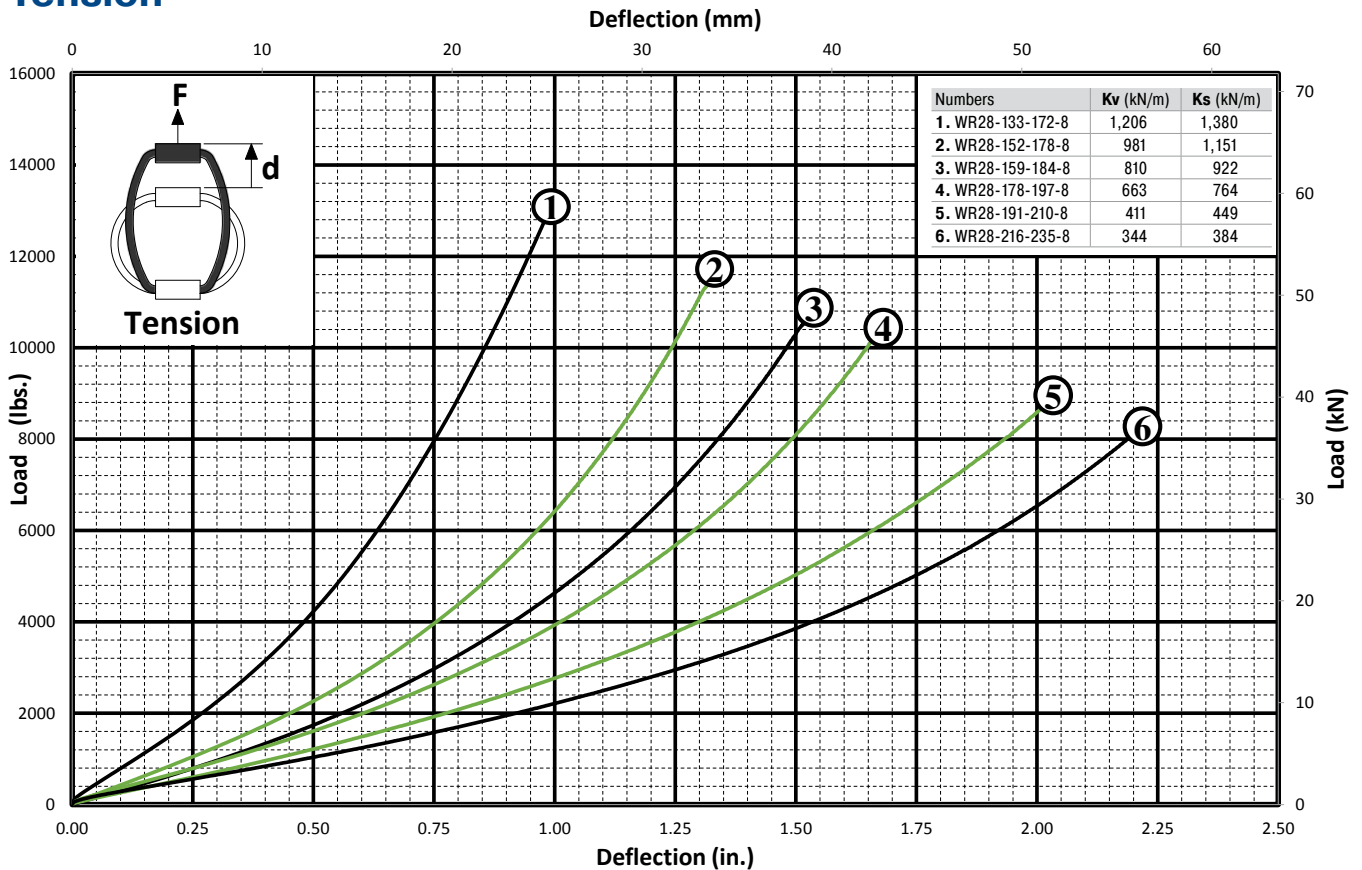

Issue 07.2020 – Specifications subject to change

### Shear

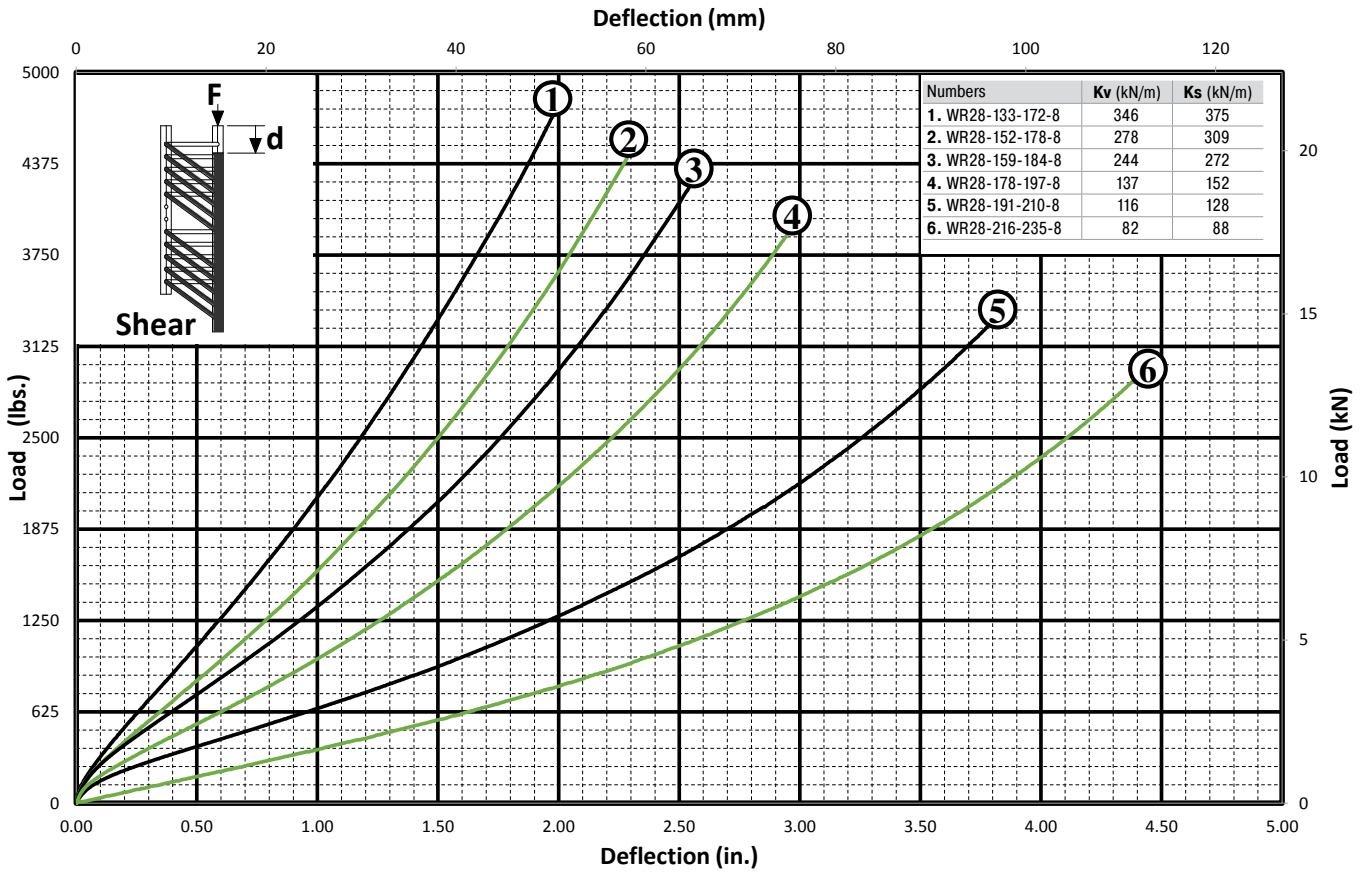

### Roll

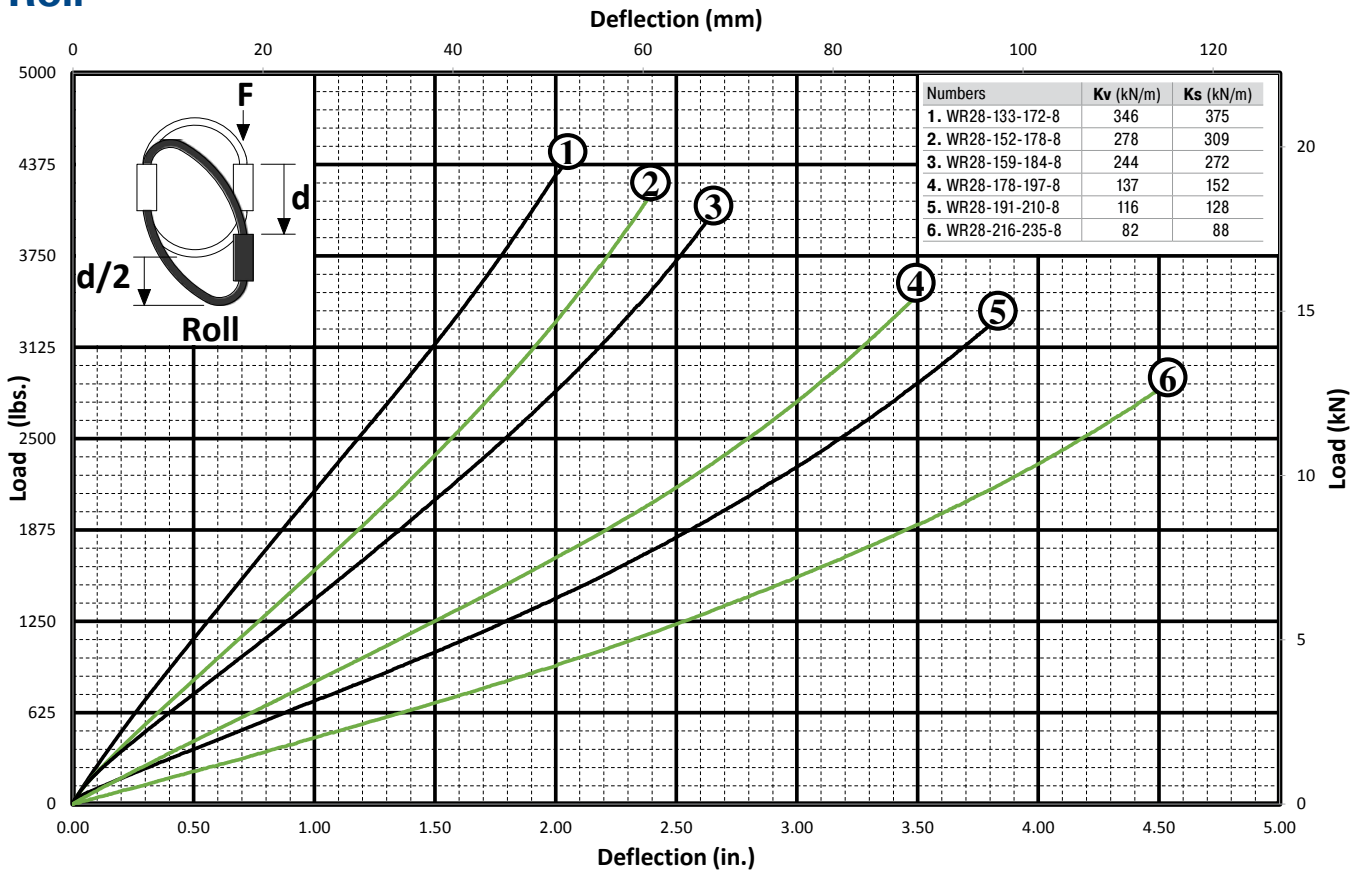

### 45° Compression/Roll

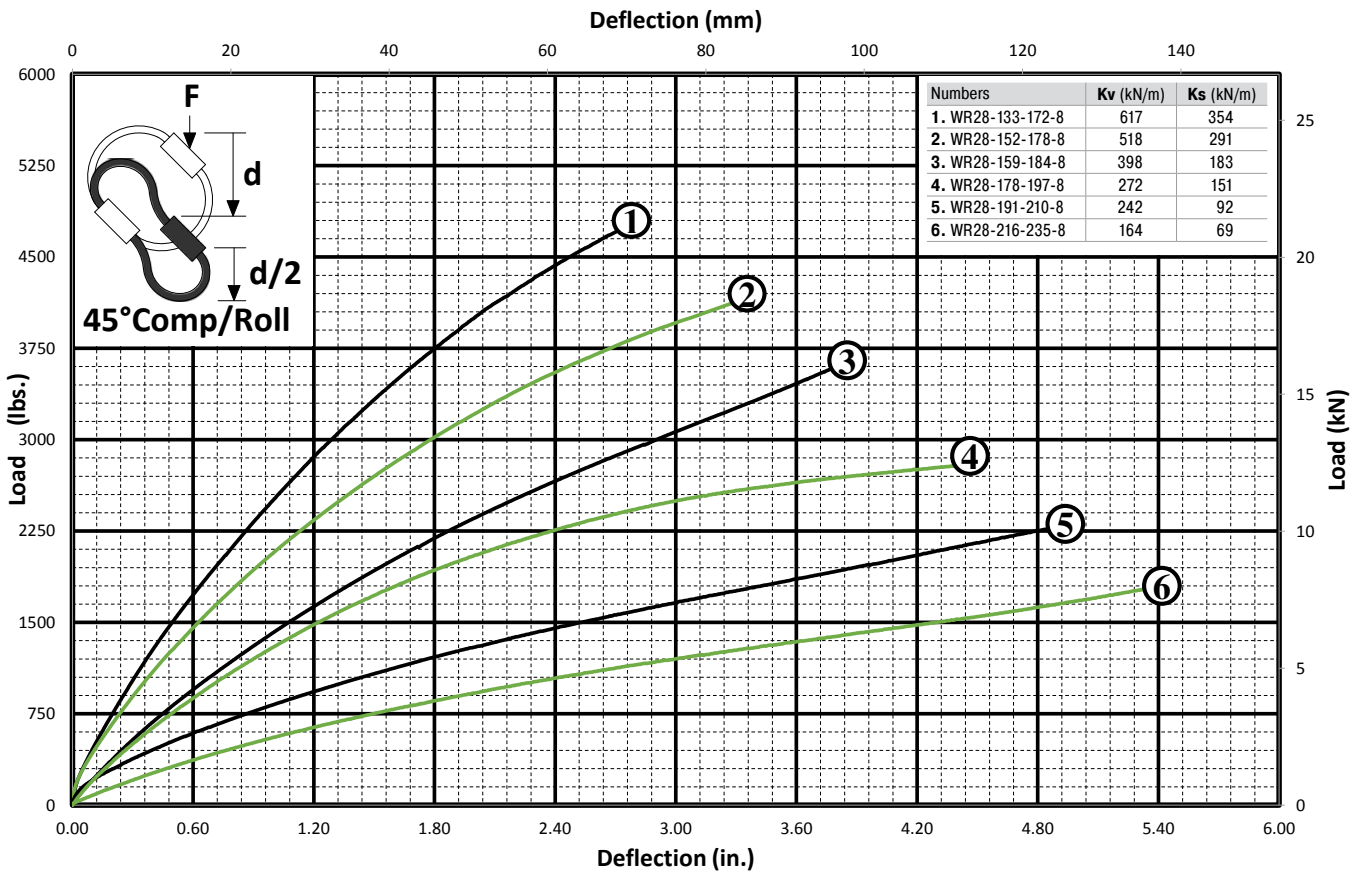

### 45° Tension/Roll

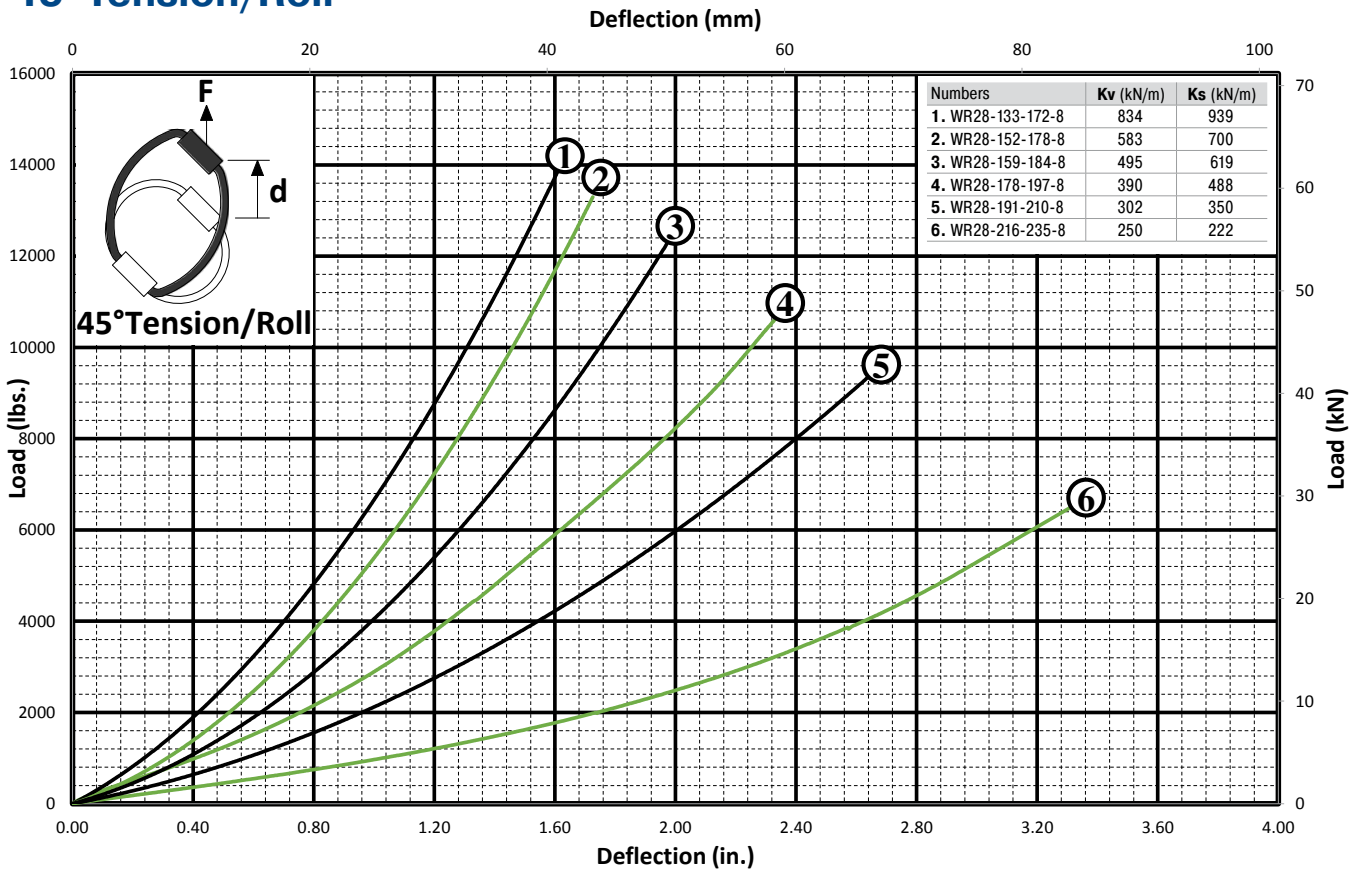

Issue 07.2020 – Specifications subject to change

Product also available in stainless steel



# WR32

## Helical Isolator

### 25.40 mm (1") Diameter Cable



**Features**

- Rugged all metal construction
- Fail safe construction
- Long life and maintenance free
- Three axis capability (6 dof)
- High damping: C/cc ≈ 0.15 to 0.20

**Operating temperature range**

-130°C to +260°C

**Material**

- Cable: 300 Series SS per MIL-W-83420 or RR-W-410
- Screws: 300 Series SS passivated IAW ASTM A967
- Inserts: 300 Series SS (Alum bars only)
- Retainer bars: Standard: 6061-T6 Alum alloy/ Chem film IAW MIL-DTL-5541, TYPE II, Class 3

**Note**

- Mounting hole tolerances: ±0.25 mm
- Add 3.05 kg to Isolator weight for all stainless steel versions

**On request**

Special materials, size, mounting holes, finish, etc. available

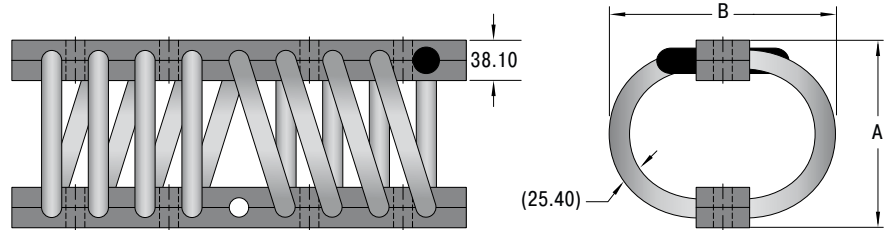
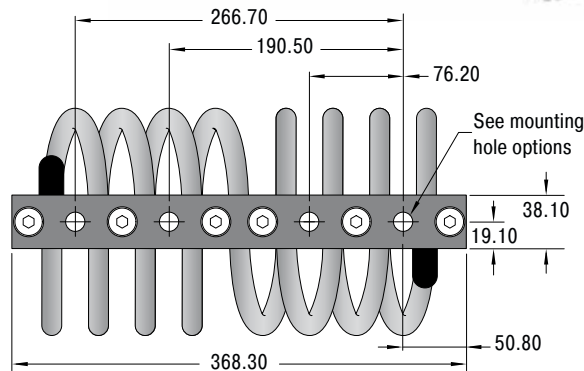

**Performance**

TYPEN	A (+/- 0.8) mm	B mm	Compression			Shear/Roll (Average)			Weight kg
			Kv (Vibe) kN/m	Ks (Shock) kN/m	Deflection max. mm	Kv (Vibe) kN/m	Ks (Shock) kN/m	Deflection max. mm	
WR32-133-178-8	133.4	177.8	1,901	1,083	45.7	850	559	45.7	11.320
WR32-152-184-8	152.4	184.2	1,607	915	66.0	667	450	66.0	11.710
WR32-159-191-8	158.8	190.5	1,311	719	71.1	637	421	71.1	12.080
WR32-178-203-8	177.8	203.2	751	427	88.9	457	306	88.9	12.890
WR32-191-216-8	190.5	215.9	663	368	101.6	358	220	101.6	14.170
WR32-216-241-8	215.9	241.3	502	277	127.0	249	161	127.0	15.340

**Ordering Example**

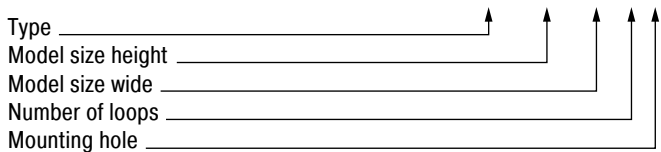

**Mounting Hole Options**

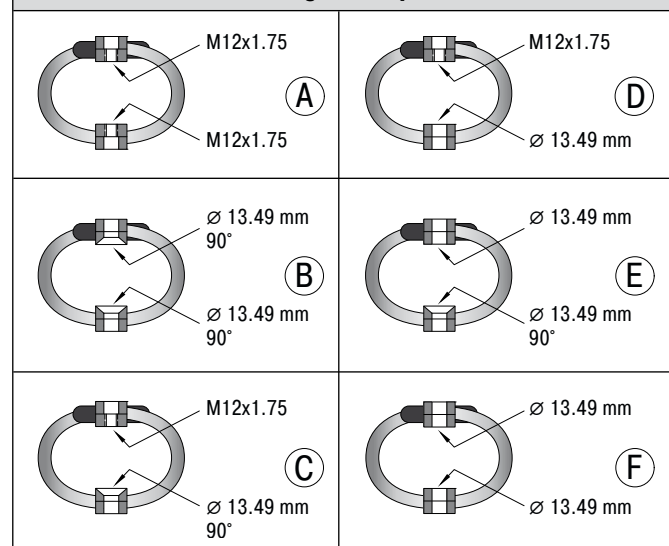

Issue 07.2020 – Specifications subject to change

## Compression

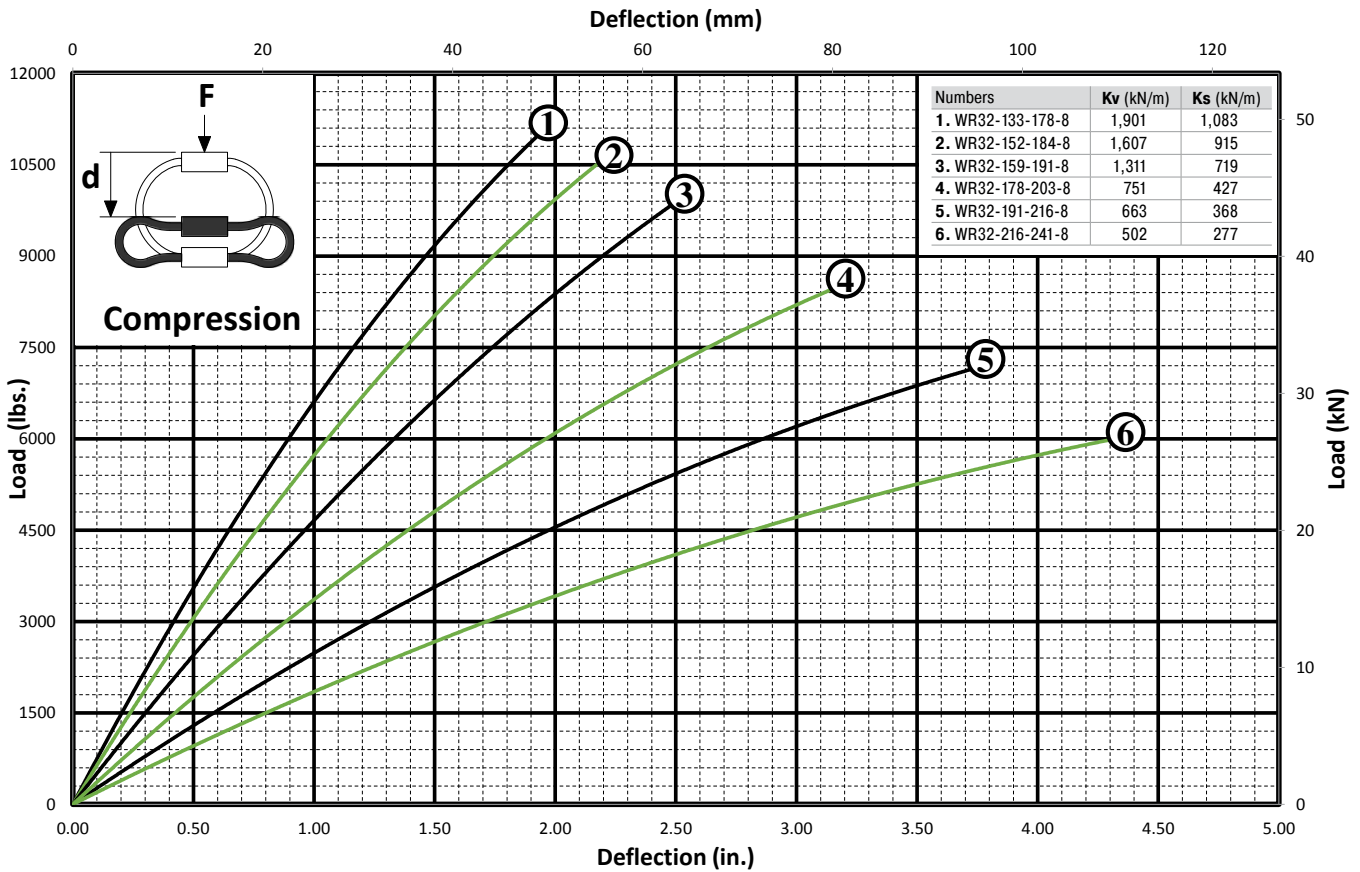

## Tension

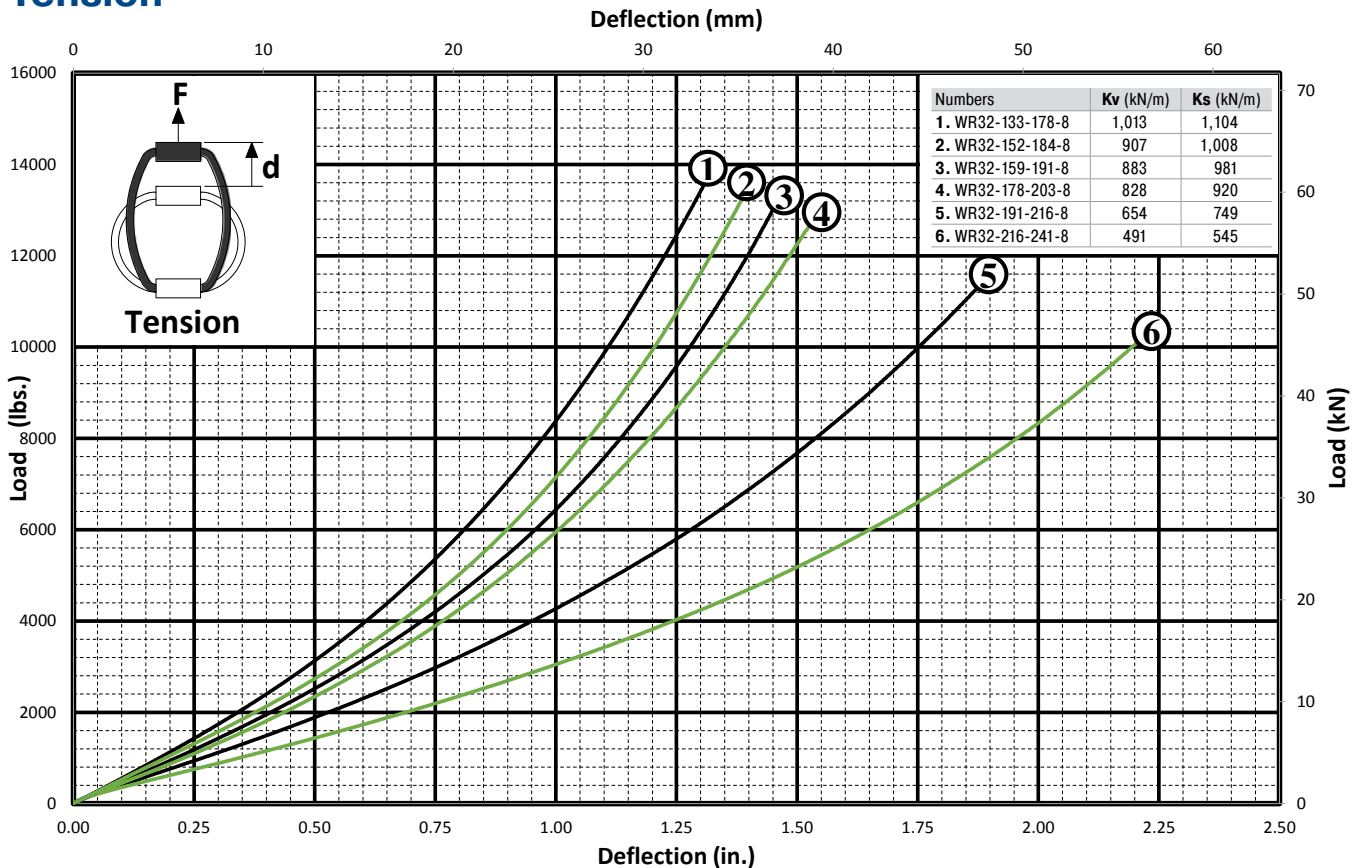



### Shear

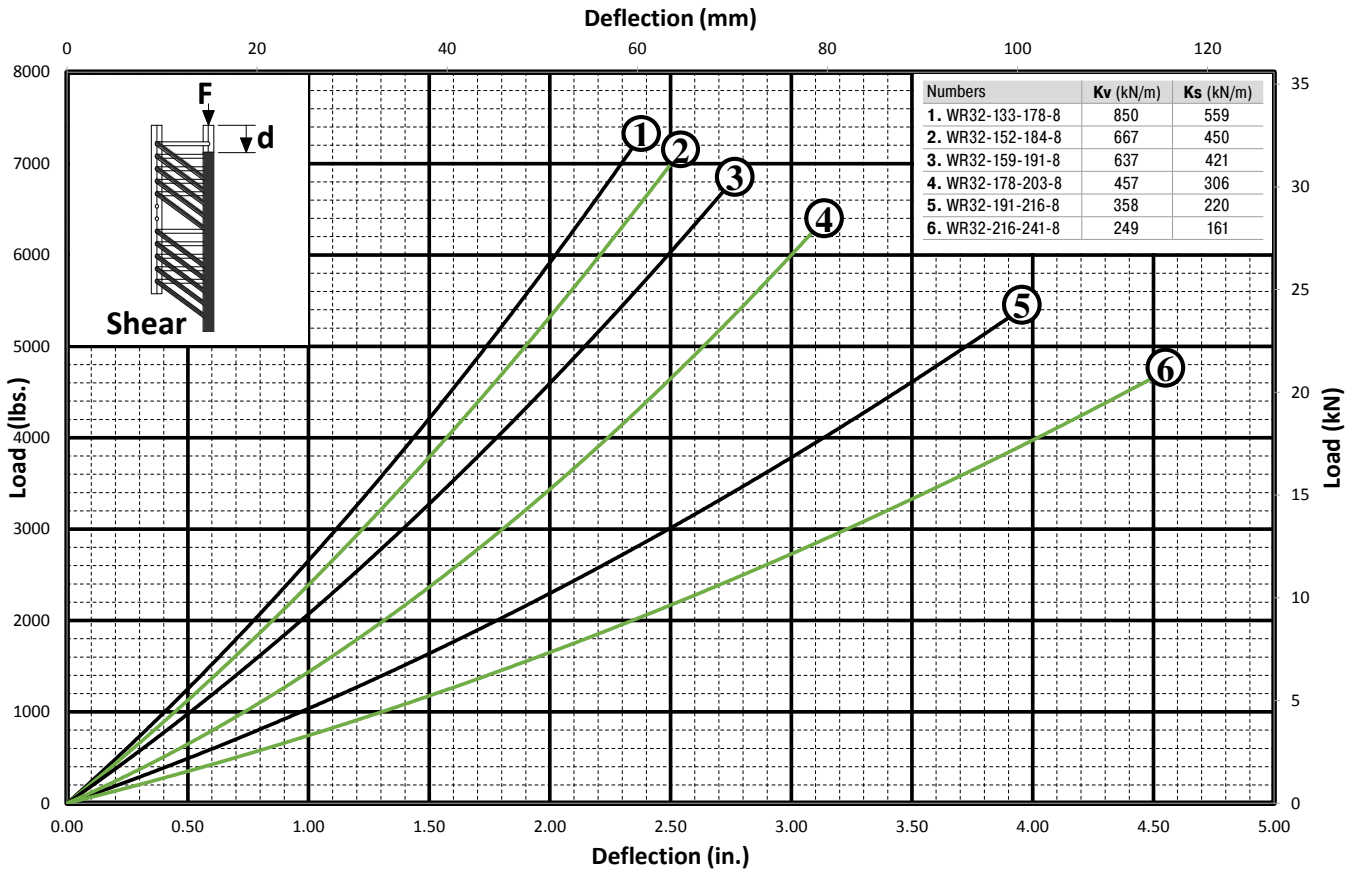

### Roll

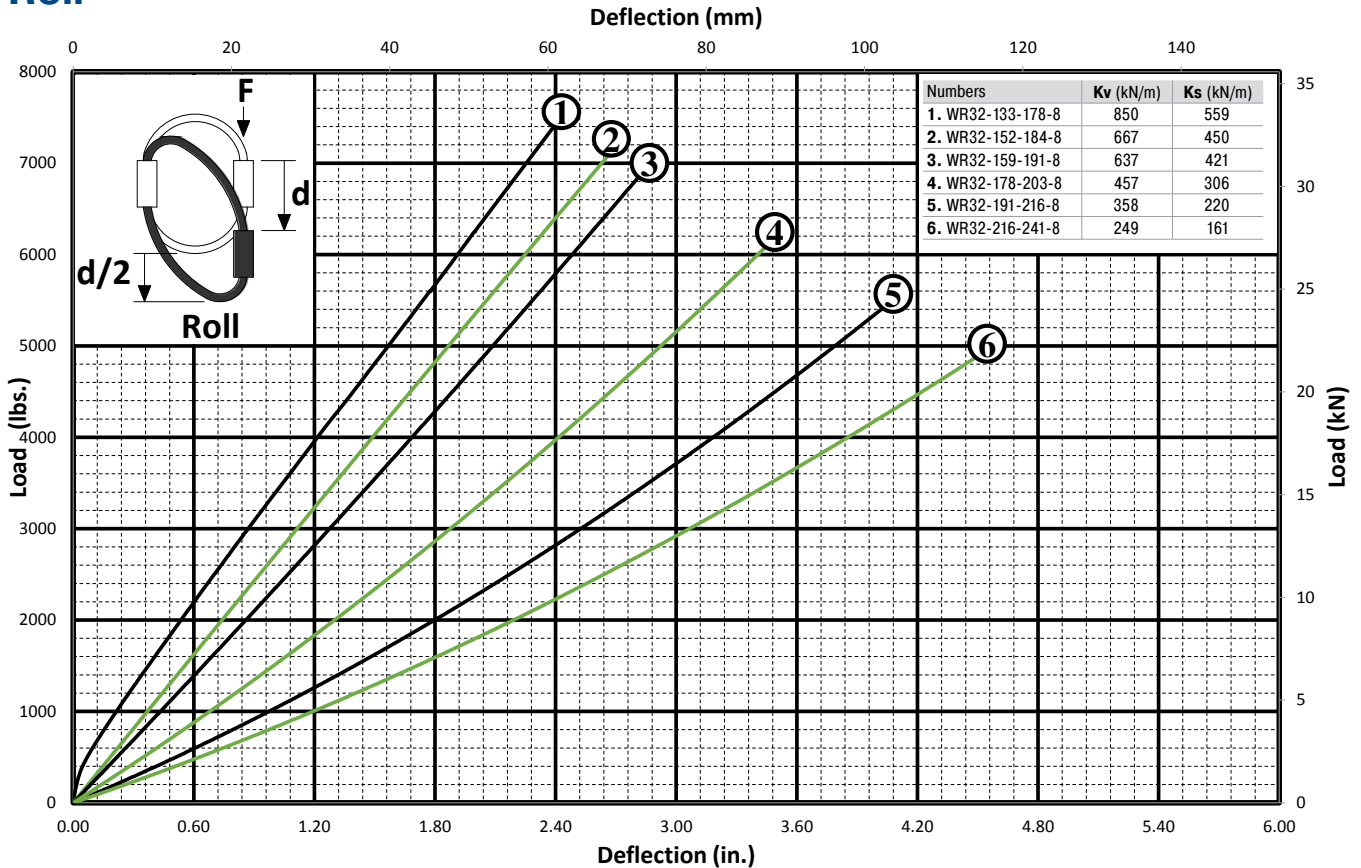

### 45° Compression/Roll

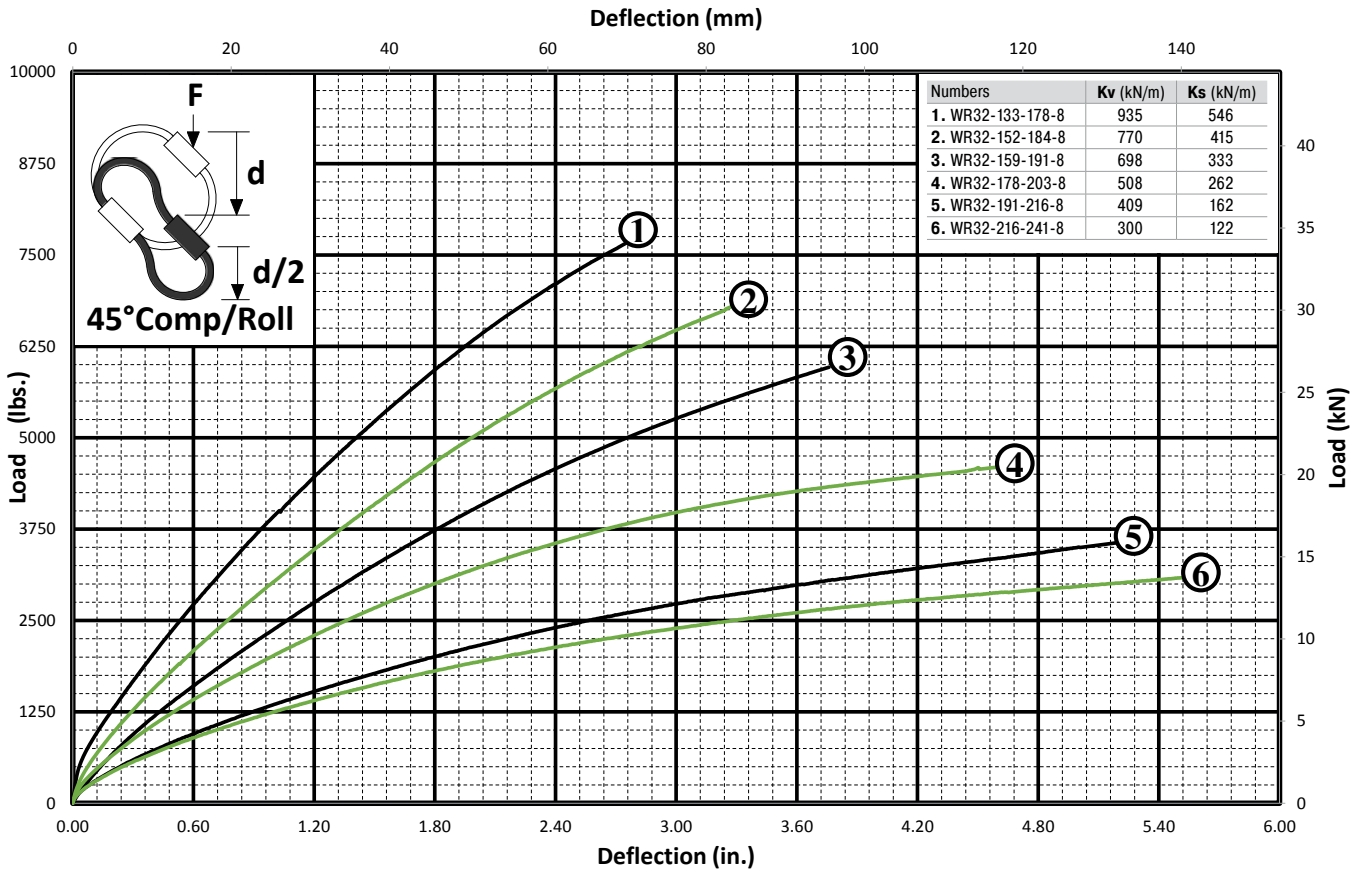

### 45° Tension/Roll

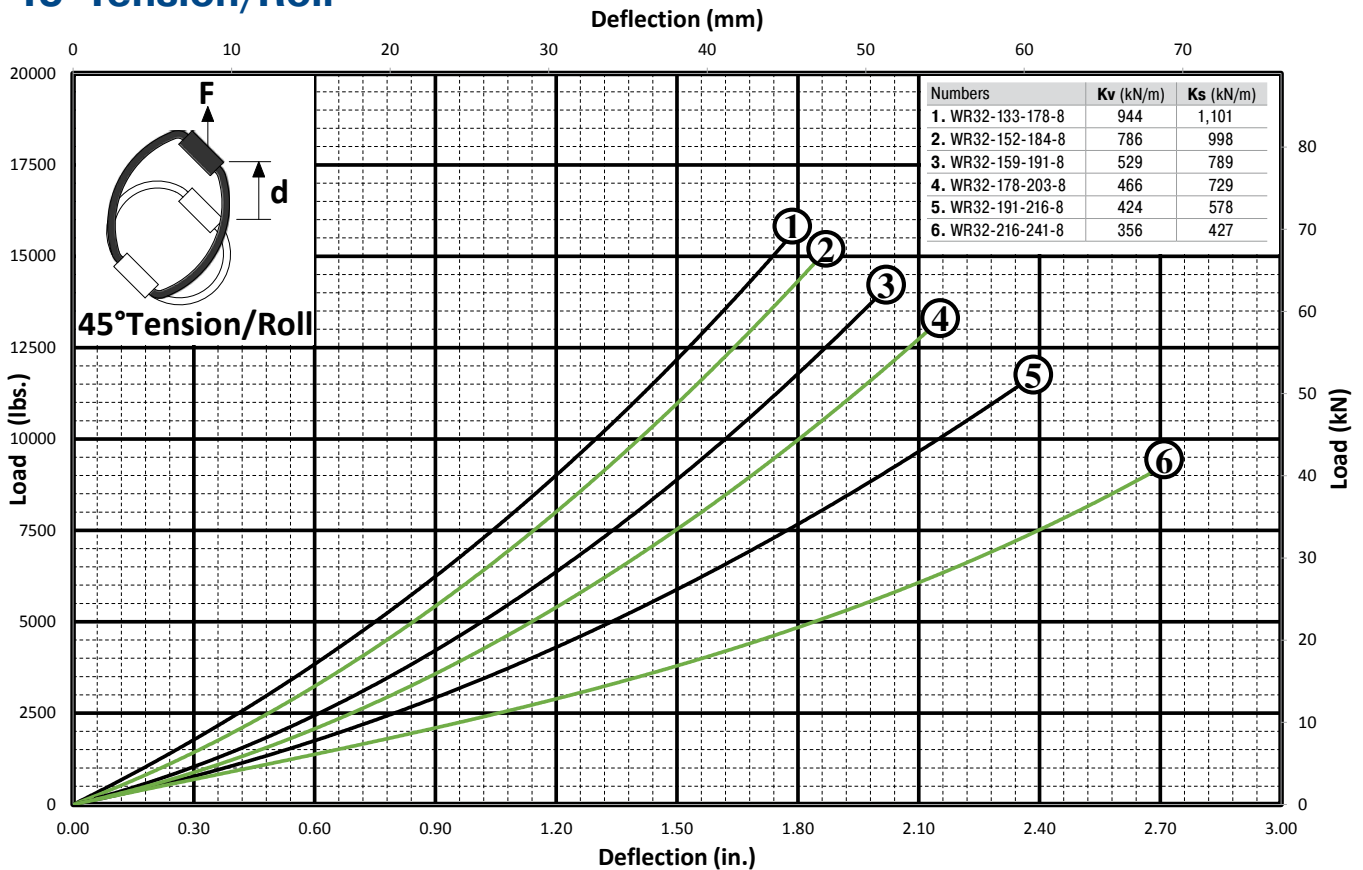

Issue 07.2020 – Specifications subject to change

Product also available in stainless steel



# WR36

## Helical Isolator

28.58 mm (1 1/8") Diameter Cable



### Features

- Rugged all metal construction
- Fail safe construction
- Long life and maintenance free
- Three axis capability (6 dof)
- High damping: C/cc ≈ 0.15 to 0.20

### Operating temperature range

-130°C to +260°C

### Material

- Cable: 300 Series SS per MIL-W-83420 or RR-W-410
- Screws: 300 Series SS passivated IAW ASTM A967
- Inserts: 300 Series SS (Alum bars only)
- Retainer bars: Standard: 6061-T6 Alum alloy/ Chem film IAW MIL-DTL-5541, TYPE II, Class 3

### Note

- Mounting hole tolerances: ±0.25 mm
- Add 9.99 kg to Isolator weight for all stainless steel versions

### On request

Special materials, size, mounting holes, finish, etc. available

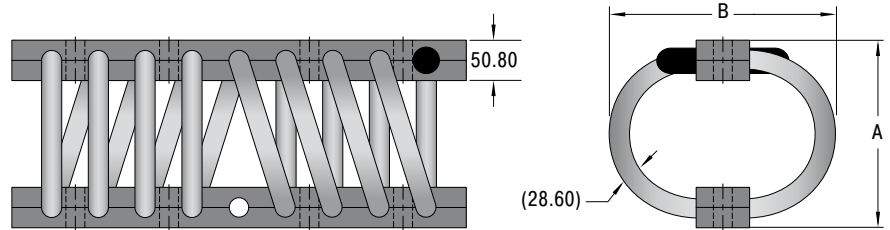
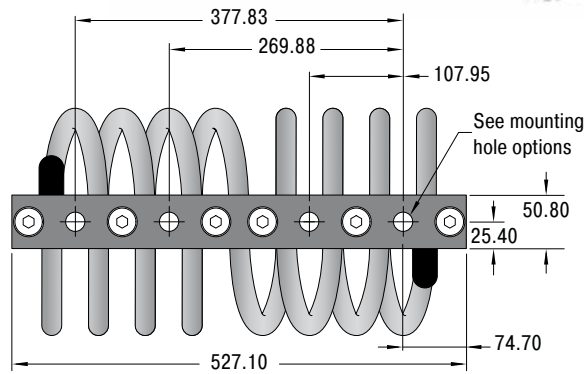

### Performance

TYPEN	A (+/- 0.8)		Compression			Shear/Roll (Average)			Weight kg
	mm	mm	Kv (Vibe) kN/m	Ks (Shock) kN/m	Deflection max. mm	Kv (Vibe) kN/m	Ks (Shock) kN/m	Deflection max. mm	
WR36-178-216-8	177.8	215.9	1,944	867	61.0	455	387	61.0	20.880
WR36-197-235-8	196.9	235.0	1,220	574	81.3	426	274	81.3	22.250
WR36-216-241-8	215.9	241.3	706	382	99.1	305	222	99.1	23.610
WR36-235-260-8	235.0	260.4	684	305	119.4	161	181	119.4	24.520

### Ordering Example

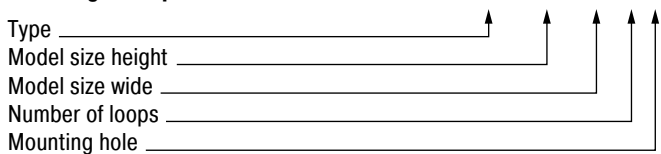

Mounting Hole Options	
<p>A</p>	<p>D</p>
<p>B</p>	<p>E</p>
<p>C</p>	<p>F</p>

Issue 07.2020 – Specifications subject to change

### Compression

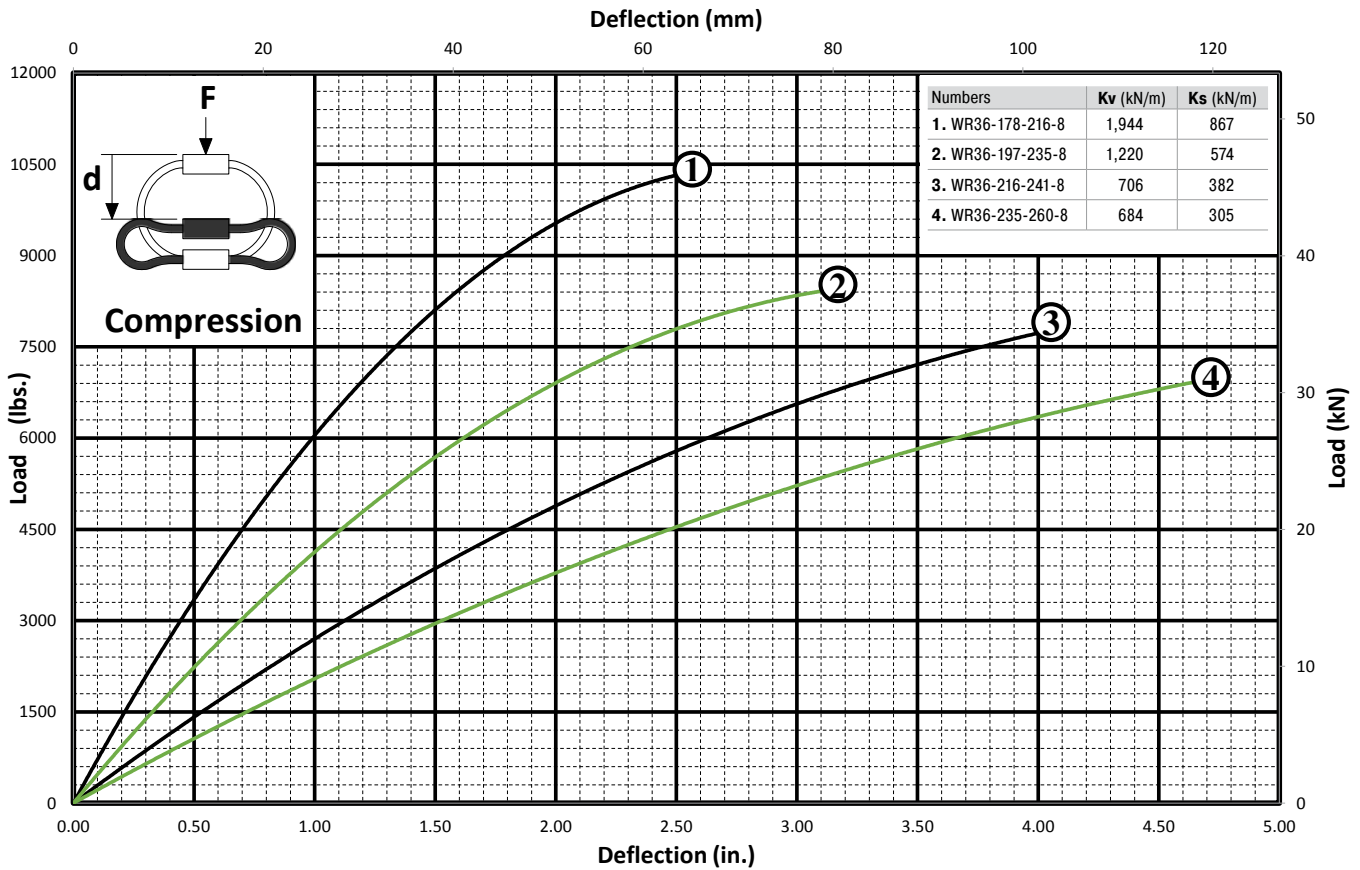

### Tension

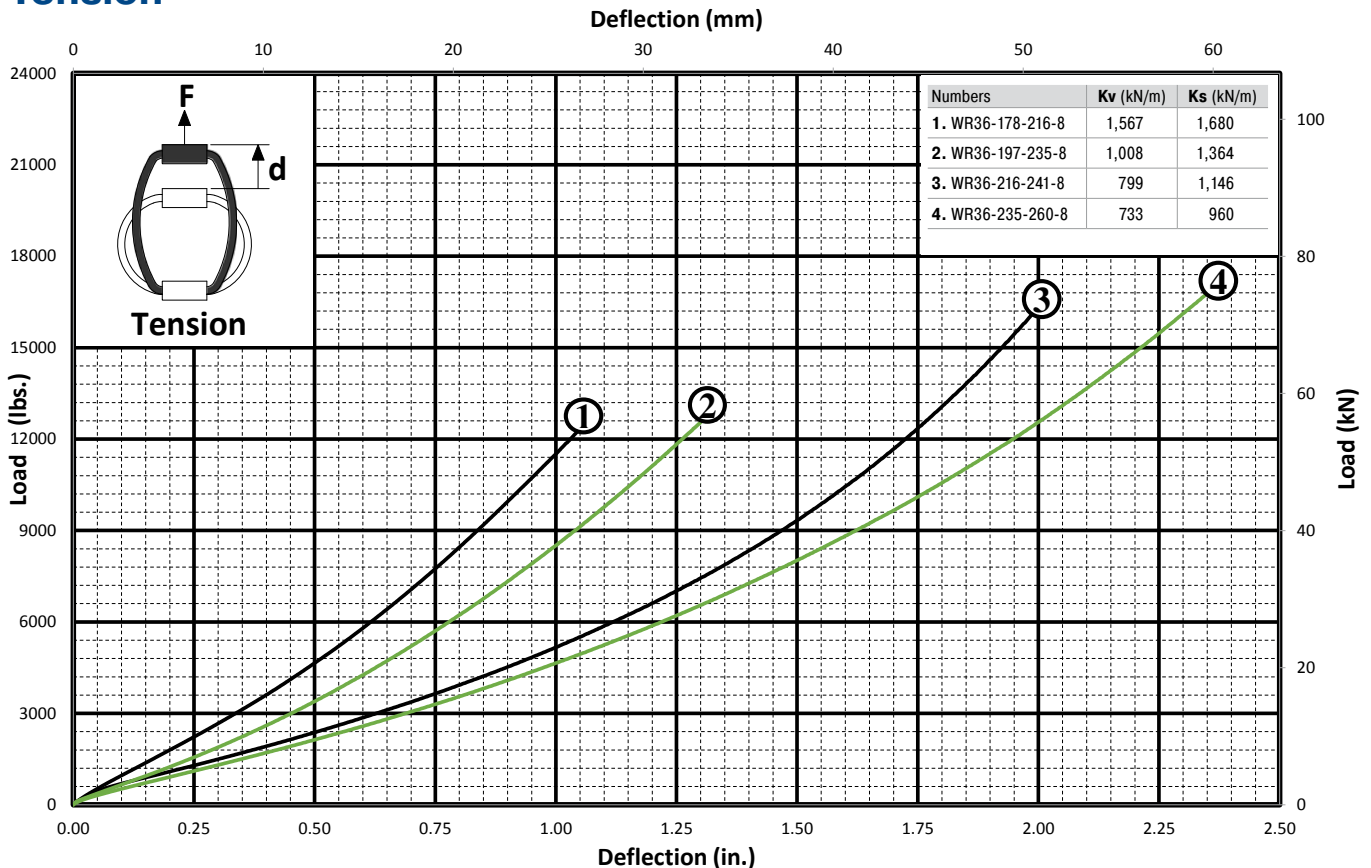

### Shear

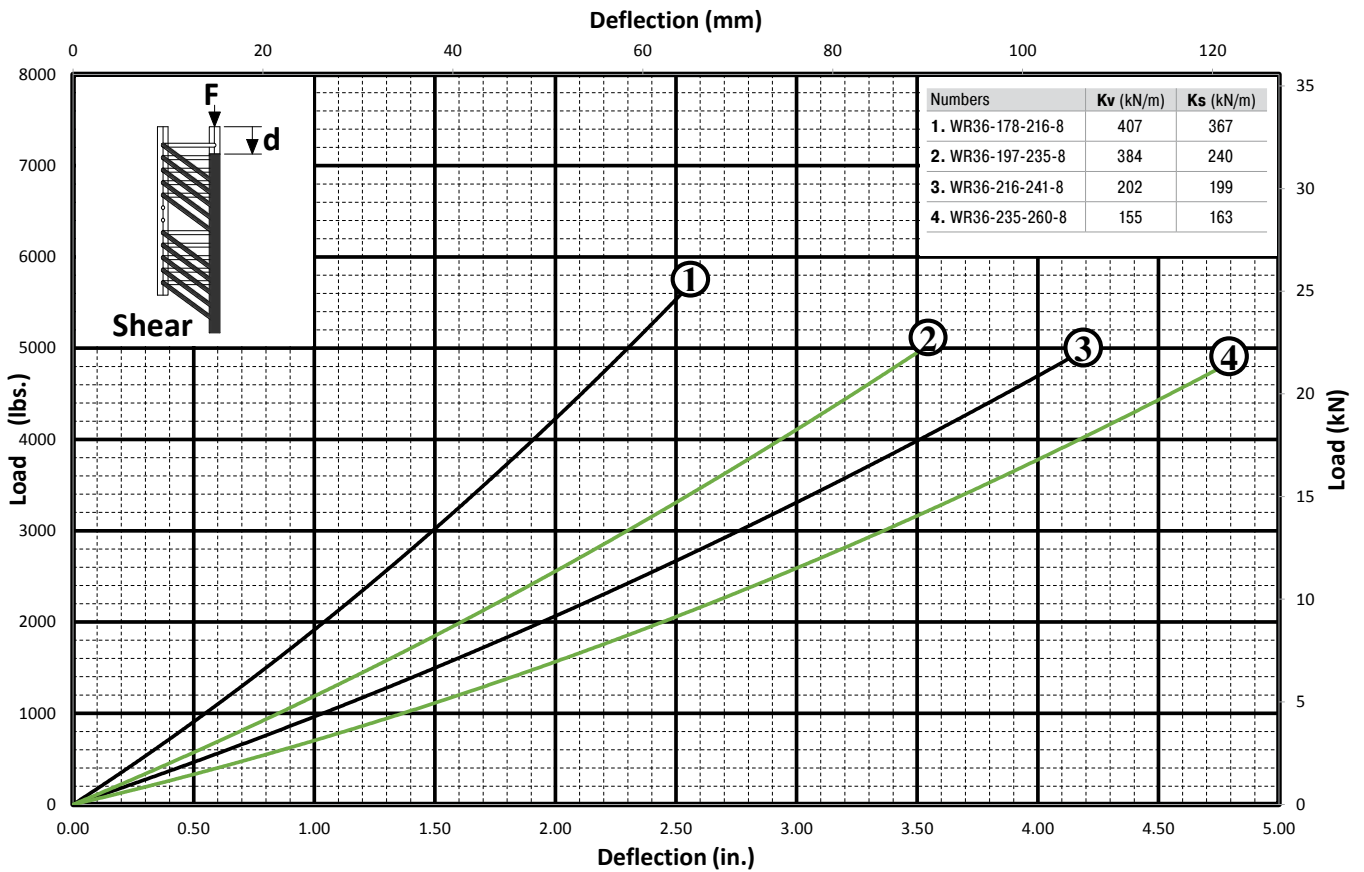

### Roll

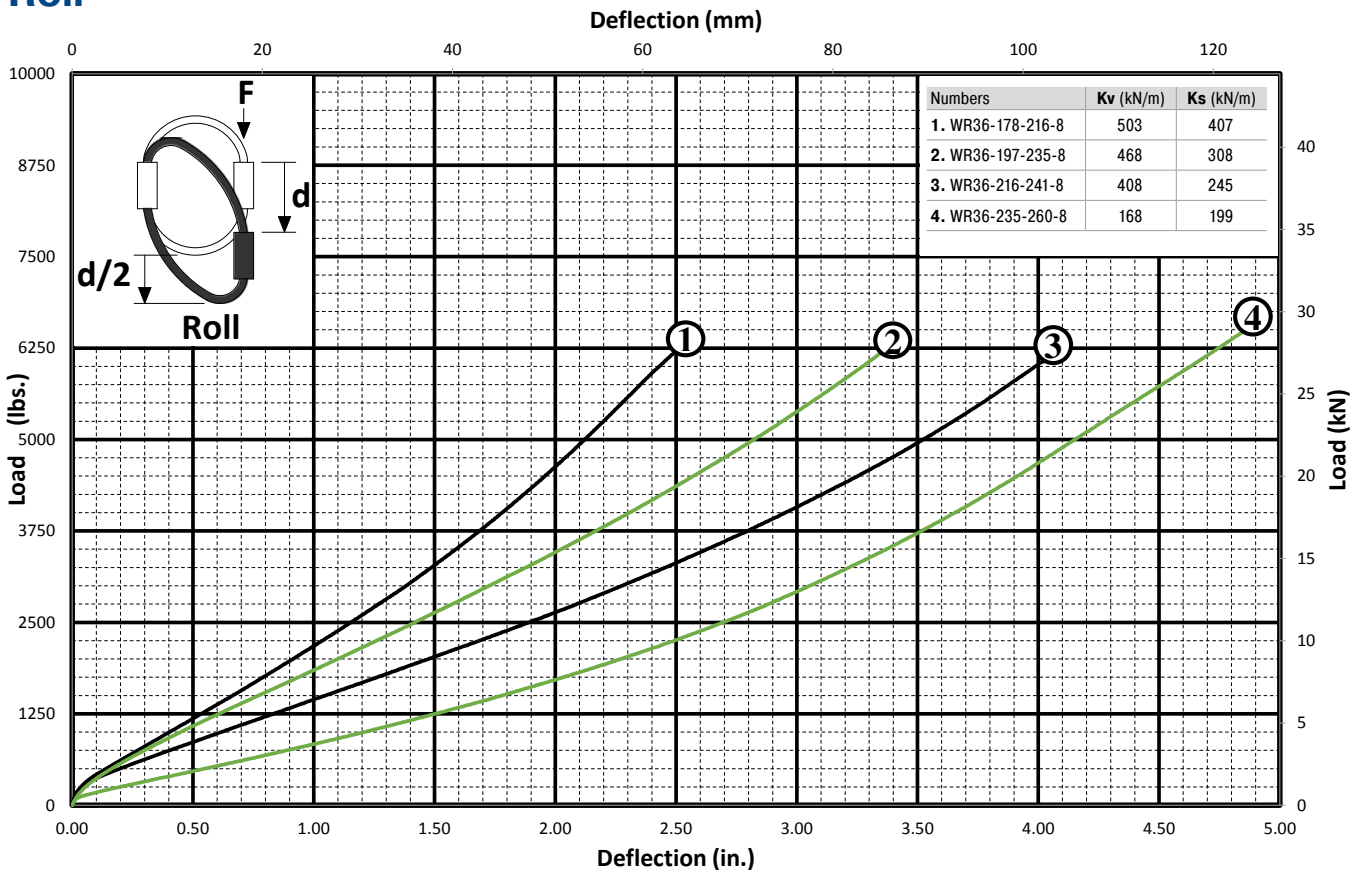



### 45° Compression/Roll

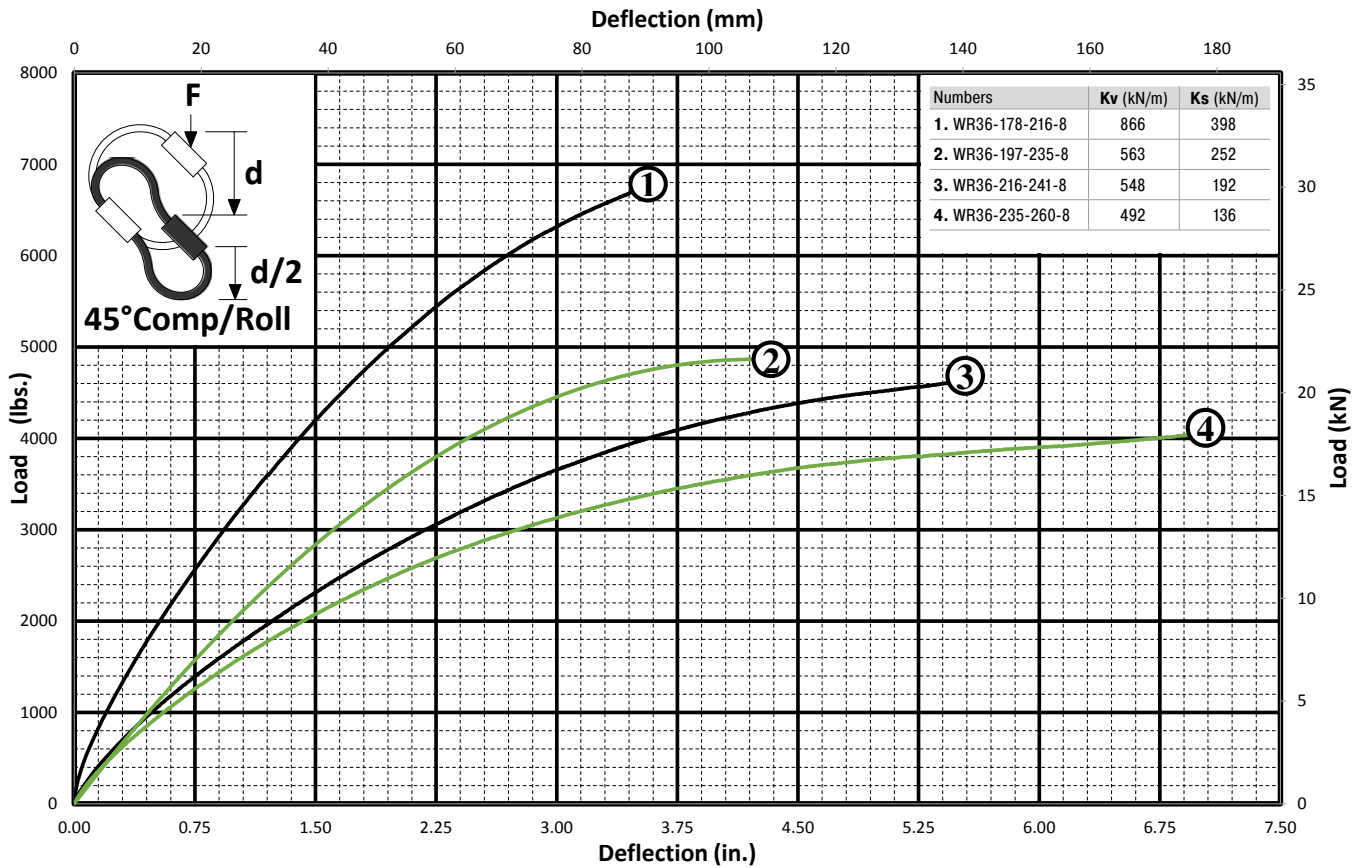

### 45° Tension/Roll

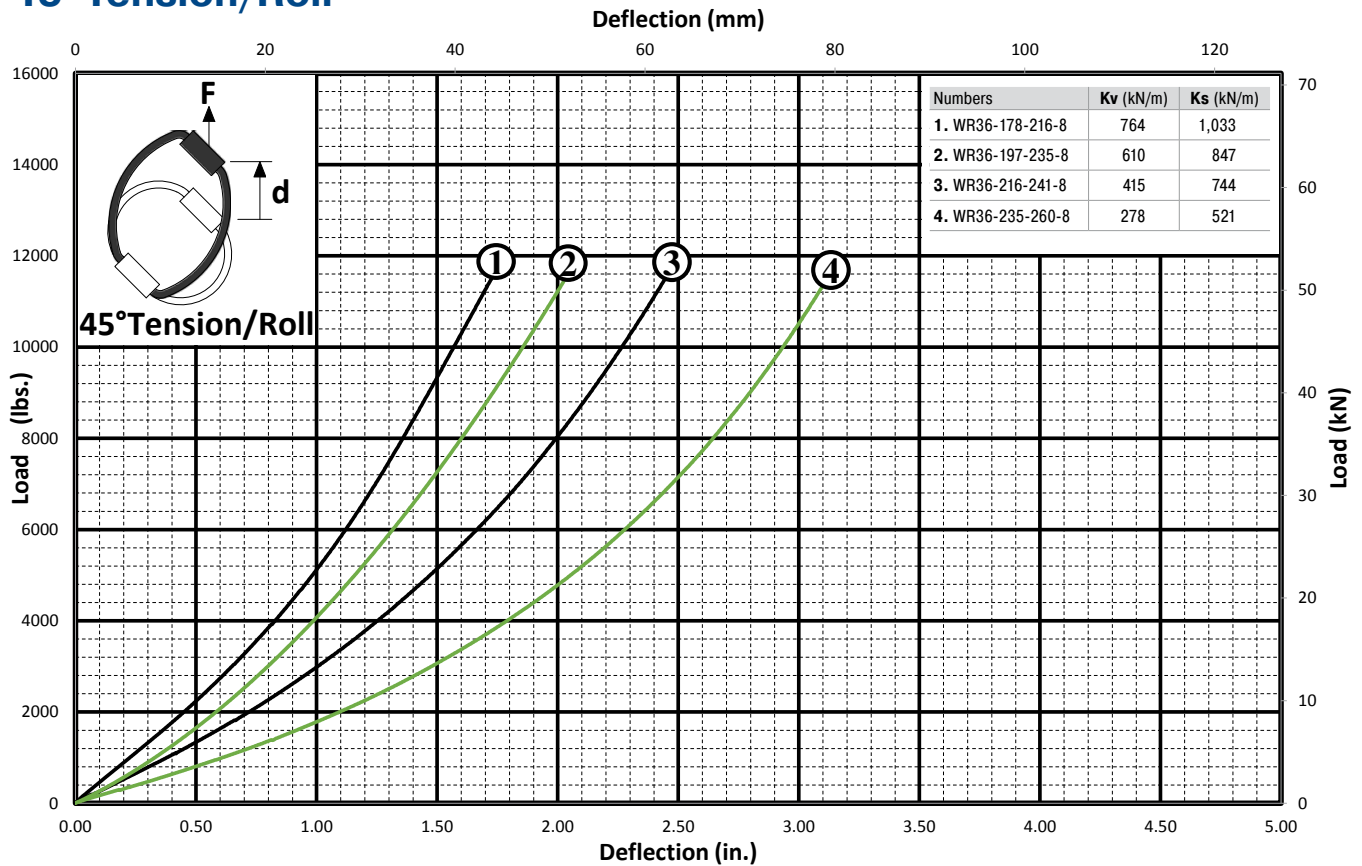

Product also available in stainless steel



# WR40

## Helical Isolator

### 31.75 mm (1¼") Diameter Cable



**Features**

- Rugged all metal construction
- Fail safe construction
- Long life and maintenance free
- Three axis capability (6 dof)
- High damping: C/cc ≈ 0.15 to 0.20

**Operating temperature range**

-130°C to +260°C

**Material**

- Cable: 300 Series SS per MIL-W-83420 or RR-W-410
- Screws: 300 Series SS passivated IAW ASTM A967
- Inserts: 300 Series SS (Alum bars only)
- Retainer bars: Standard: 6061-T6 Alum alloy/ Chem film IAW MIL-DTL-5541, TYPE II, Class 3

**Note**

- Mounting hole tolerances: ±0.25 mm
- Add 8.39 kg to Isolator weight for all stainless steel versions

**On request**

Special materials, size, mounting holes, finish, etc. available

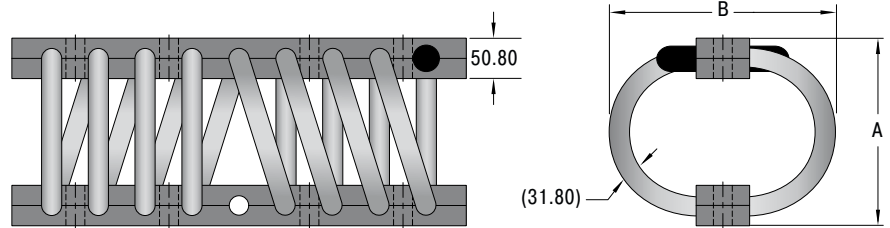
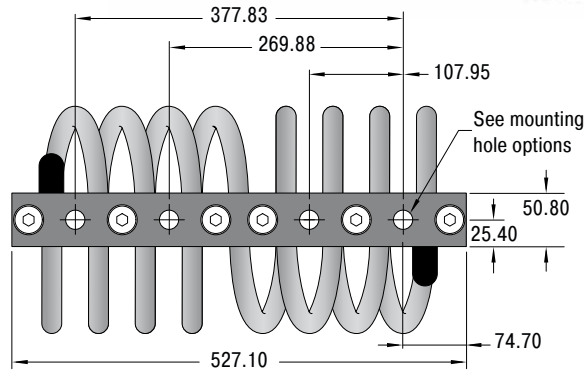

**Performance**

TYPEN	A (+/- 0.8) mm	B mm	Compression			Shear/Roll (Average)			Weight kg
			Kv (Vibe) kN/m	Ks (Shock) kN/m	Deflection max. mm	Kv (Vibe) kN/m	Ks (Shock) kN/m	Deflection max. mm	
WR40-178-229-8	177.8	228.6	2,219	1,249	61.0	652	500	61.0	24.060
WR40-197-254-8	196.9	254.0	1,695	714	81.3	635	389	81.3	25.420
WR40-216-260-8	215.9	260.4	1,255	556	99.1	434	276	99.1	27.240
WR40-235-273-8	235.0	273.1	1,109	476	119.4	388	272	119.4	28.600

**Ordering Example**

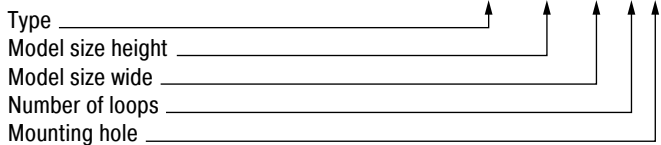

Mounting Hole Options	
<p>A</p>	<p>D</p>
<p>B</p>	<p>E</p>
<p>C</p>	<p>F</p>

### Compression

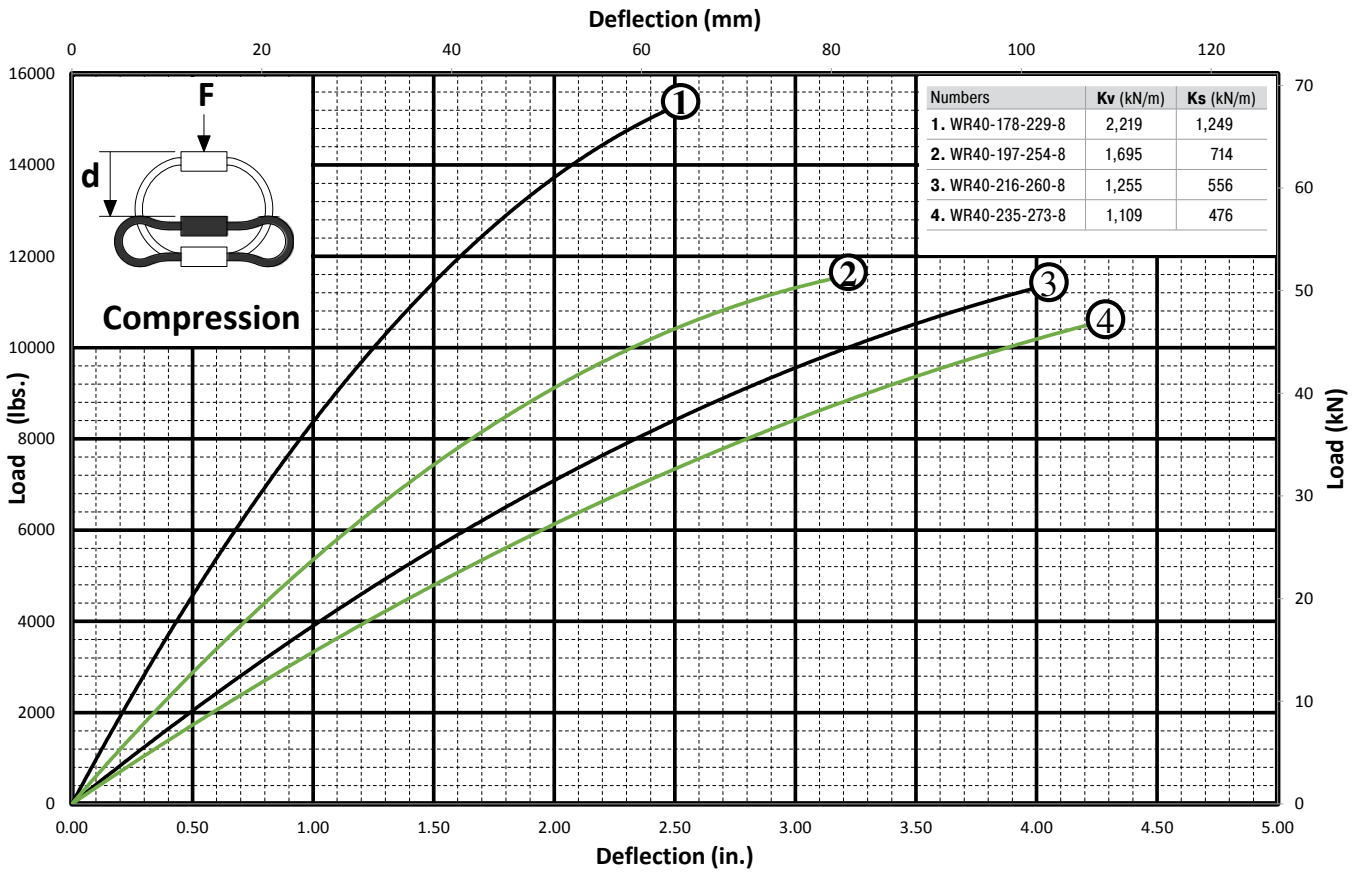

### Tension

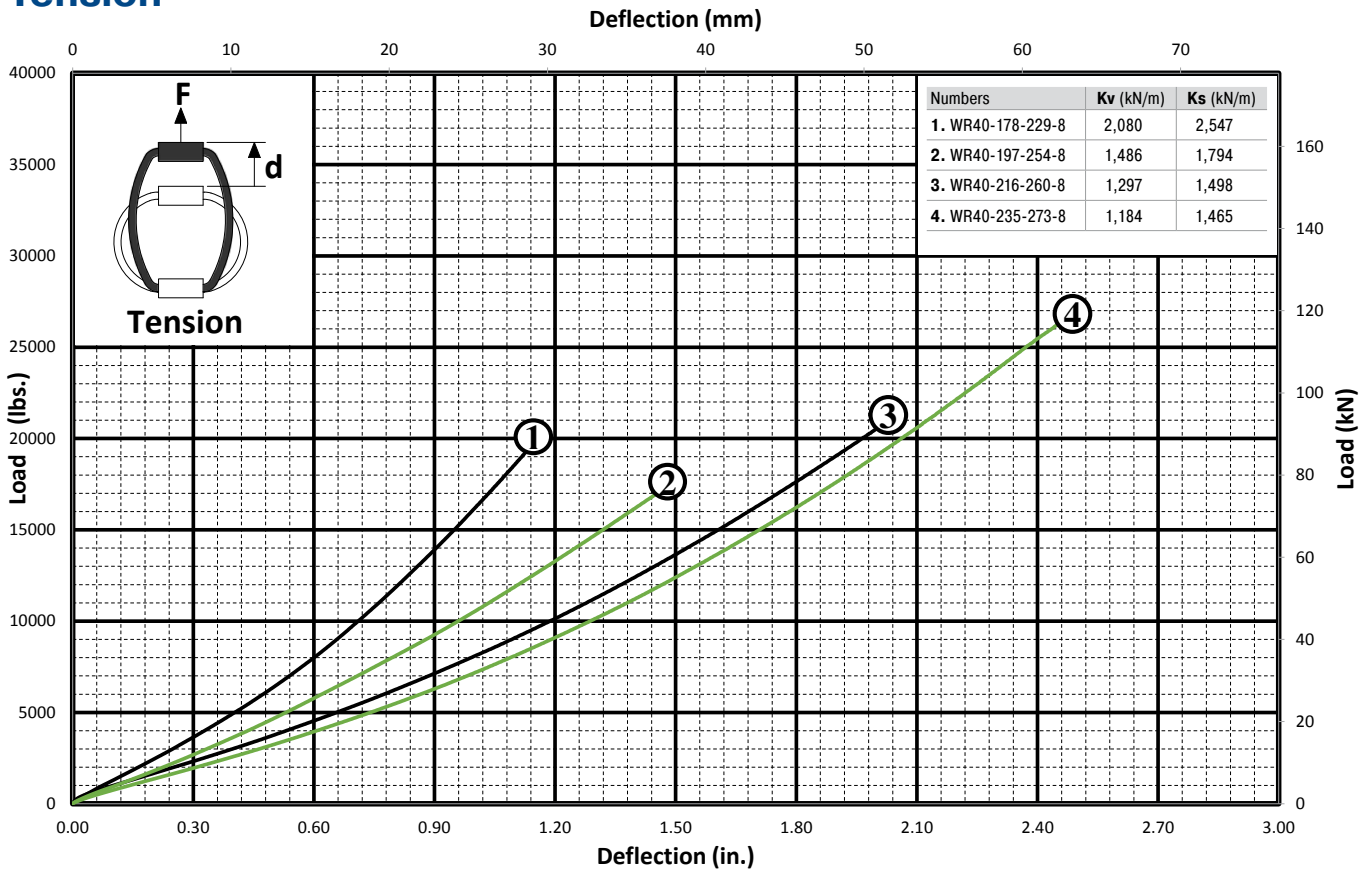

Issue 07.2020 – Specifications subject to change

### Shear

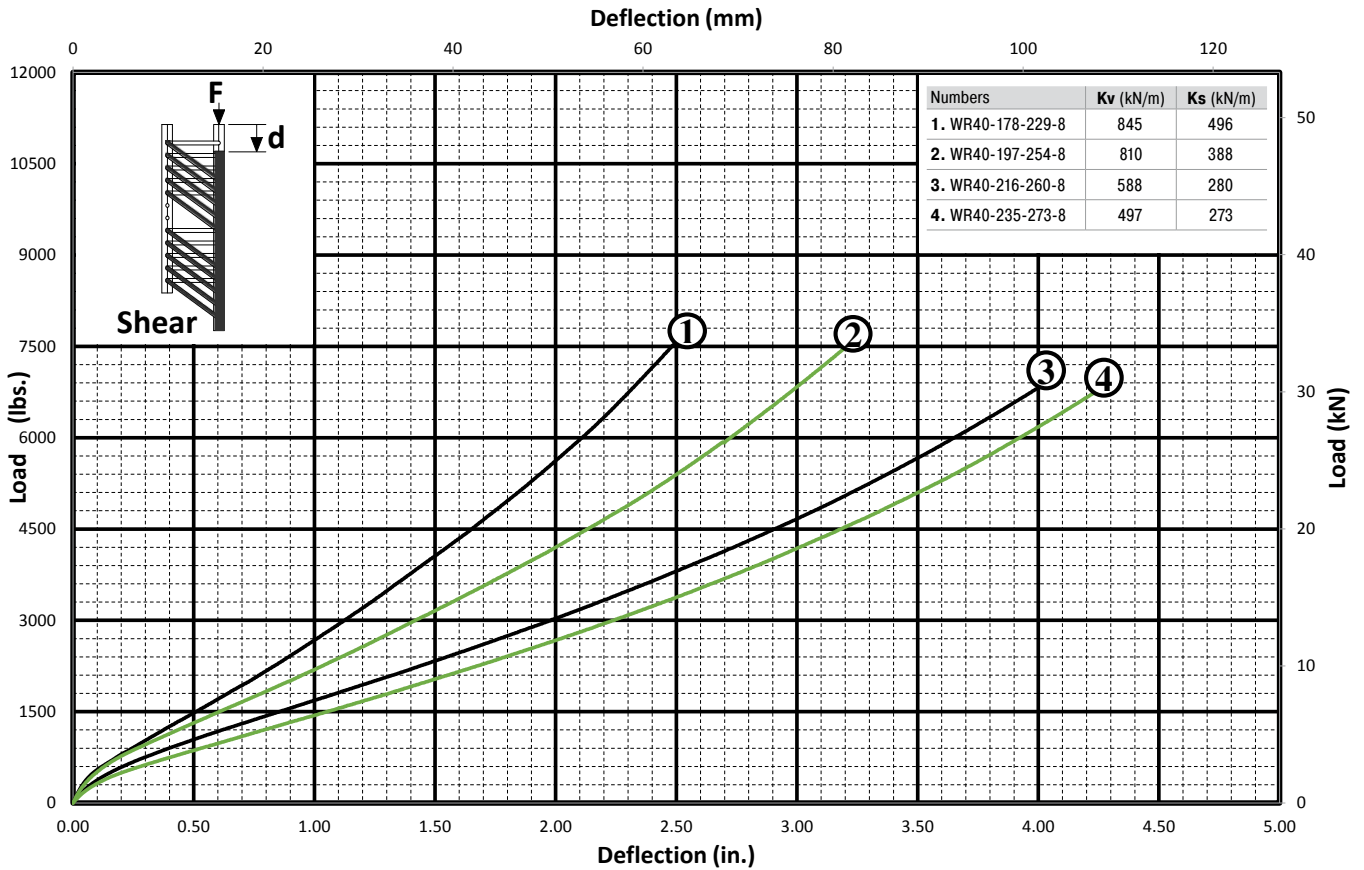

### Roll

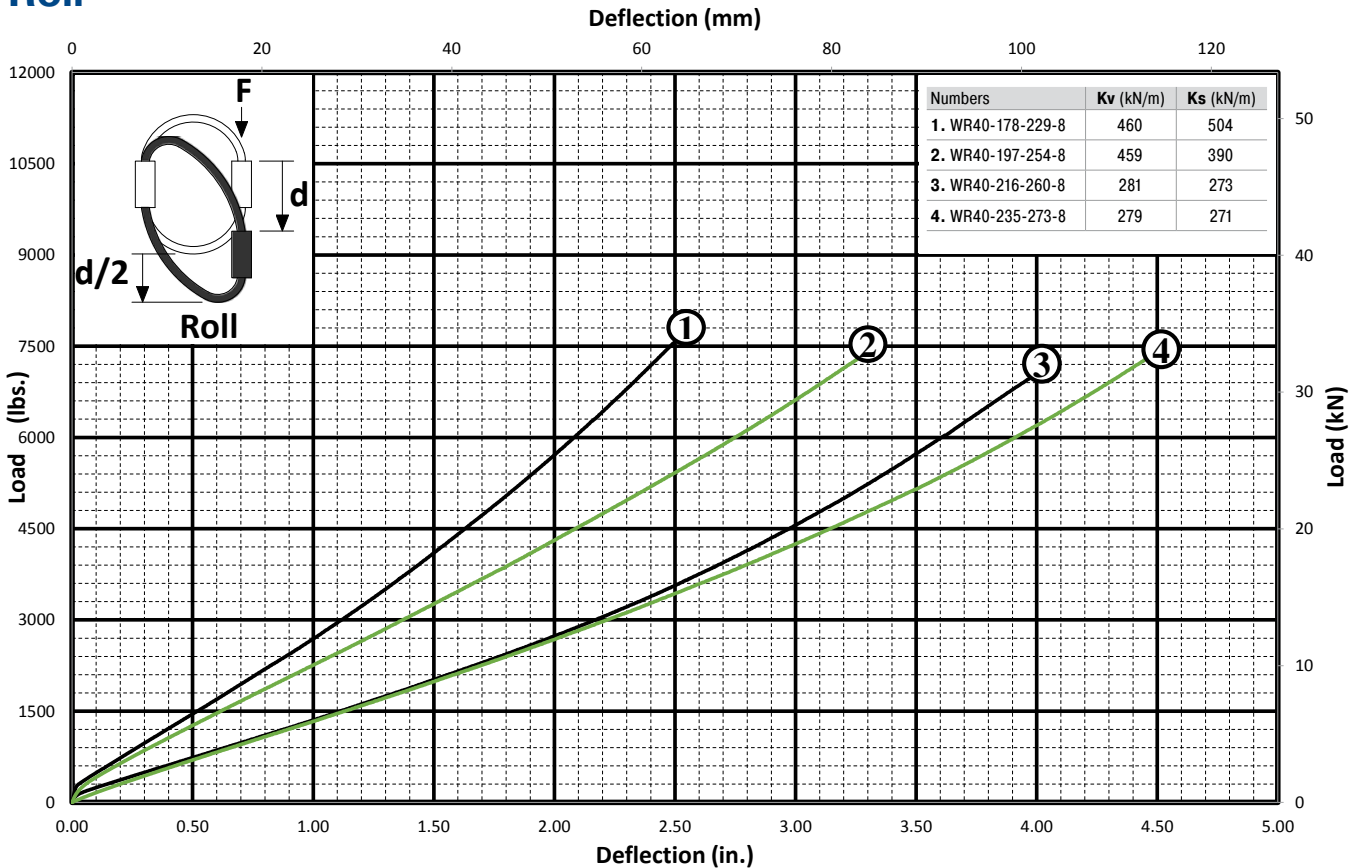

### 45° Compression/Roll

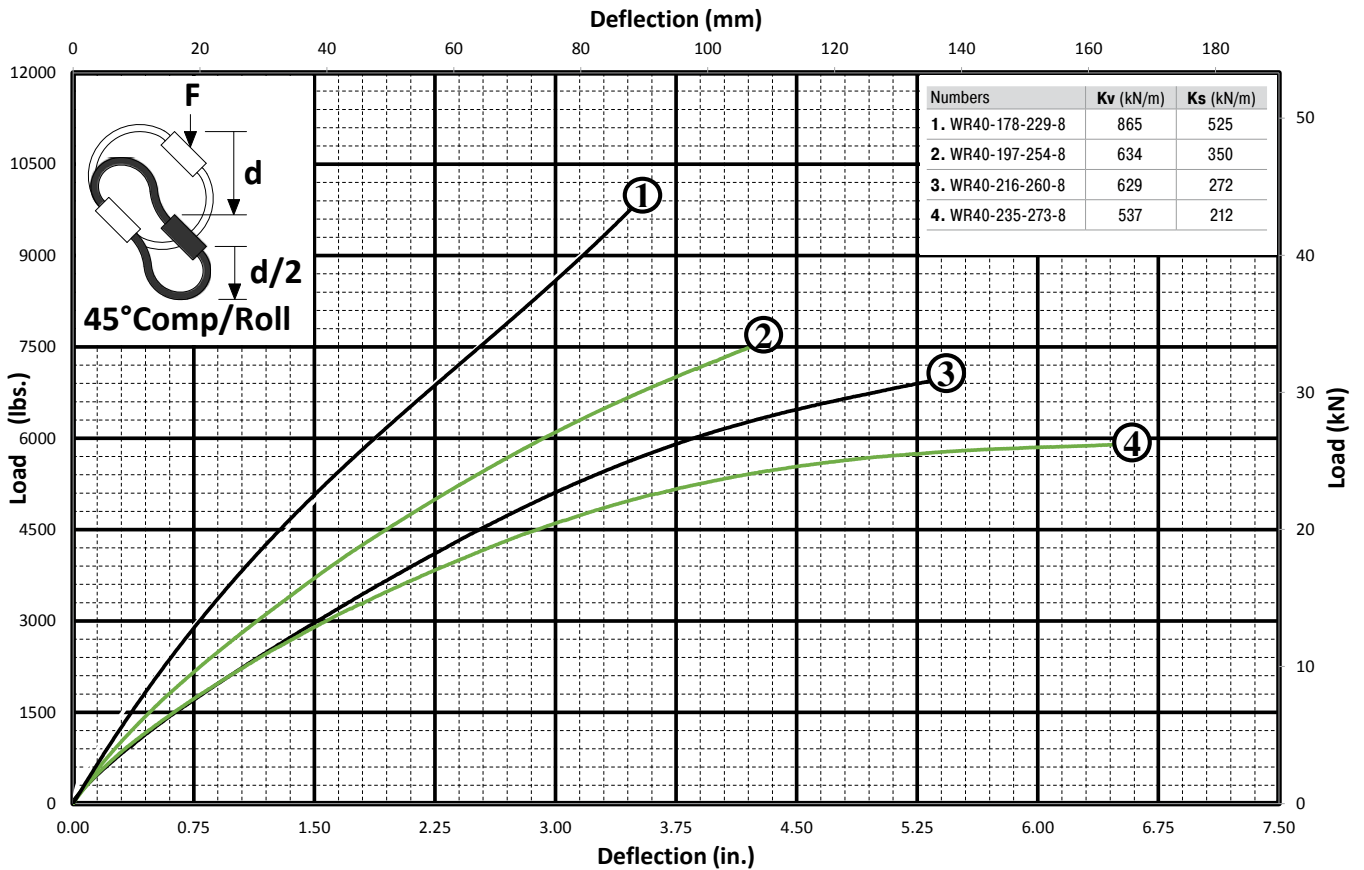

### 45° Tension/Roll

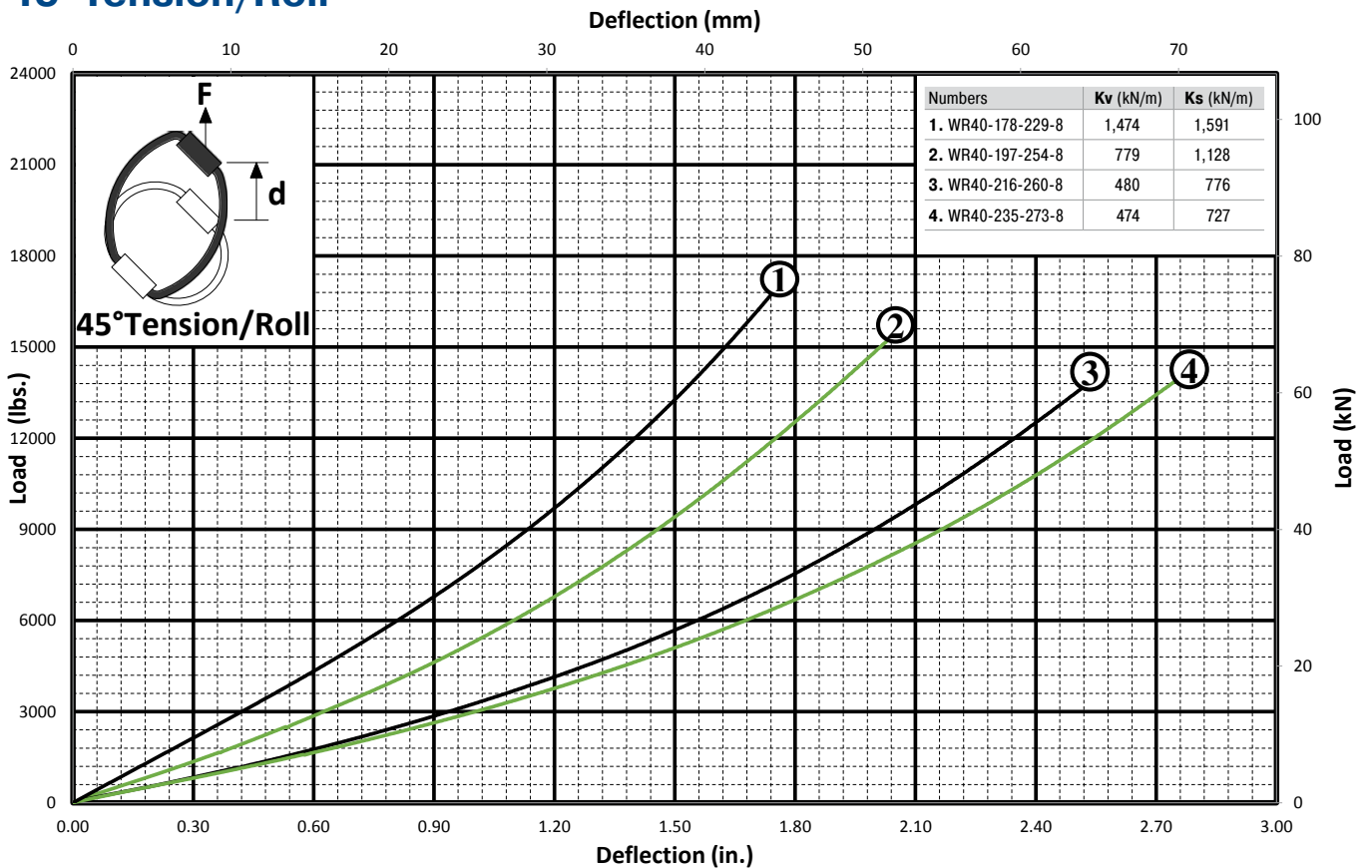



Product also available in stainless steel



# WRS2

## Helical Isolator Short

### 1.59 mm (1/16") Diameter Cable

#### Features

- Rugged all metal construction
- Fail safe construction
- Long life and maintenance free
- Three axis capability (6 dof)
- High damping: C/cc ≈ 0.15 to 0.20

#### Operating temperature range

-130°C to +260°C

#### Material

- Cable: 300 Series SS per MIL-W-83420 or RR-W-410
- Screws: 300 Series SS per MS51959-12
- Inserts: 300 Series SS (alum bars only)
- Retainer bars: Standard: 6061-T6 Alum alloy/ Chem film IAW MIL-DTL-5541, TYPE II, Class 3

#### Note

- Mounting hole tolerances: ±0.25 mm
- Add 0.02 kg to Isolator weight for all stainless steel versions

#### On request

Special materials, size, mounting holes, finish, etc. available

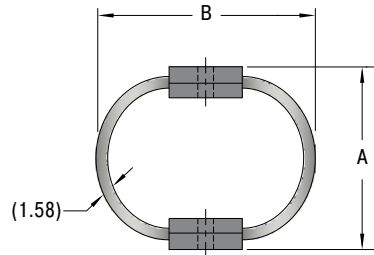
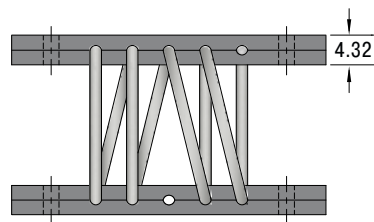
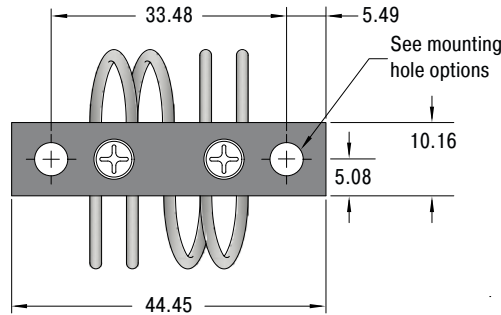

TYPEN	A (+/- 0.8)		Compression			Shear/Roll (Average)			Weight kg
	mm	mm	Kv (Vibe) kN/m	Ks (Shock) kN/m	Deflection max. mm	Kv (Vibe) kN/m	Ks (Shock) kN/m	Deflection max. mm	
WRS2-018-025-4	17.8	25.4	7.0	5.6	7.6	2.3	4.0	7.6	0.008
WRS2-020-028-4	20.3	27.9	5.8	4.9	10.2	1.9	3.5	10.2	0.009
WRS2-025-031-4	25.4	30.5	3.2	2.6	15.2	0.7	1.9	15.2	0.010
WRS2-028-033-4	27.9	33.0	2.1	1.6	17.8	0.5	1.8	17.8	0.011
WRS2-031-036-4	30.5	35.6	1.8	1.2	20.3	0.4	1.4	20.3	0.012
WRS2-033-038-4	33.0	38.1	1.4	1.1	22.9	0.4	0.5	22.9	0.014

#### Ordering Example

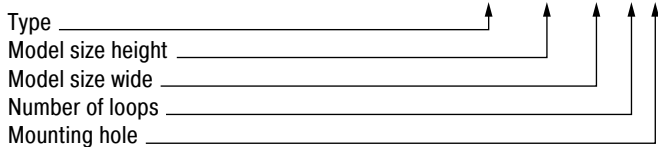

Mounting Hole Options	
<p>A</p>	<p>D</p>
<p>B</p>	<p>E</p>
<p>C</p>	<p>F</p>

Issue 07.2020 – Specifications subject to change

### Compression

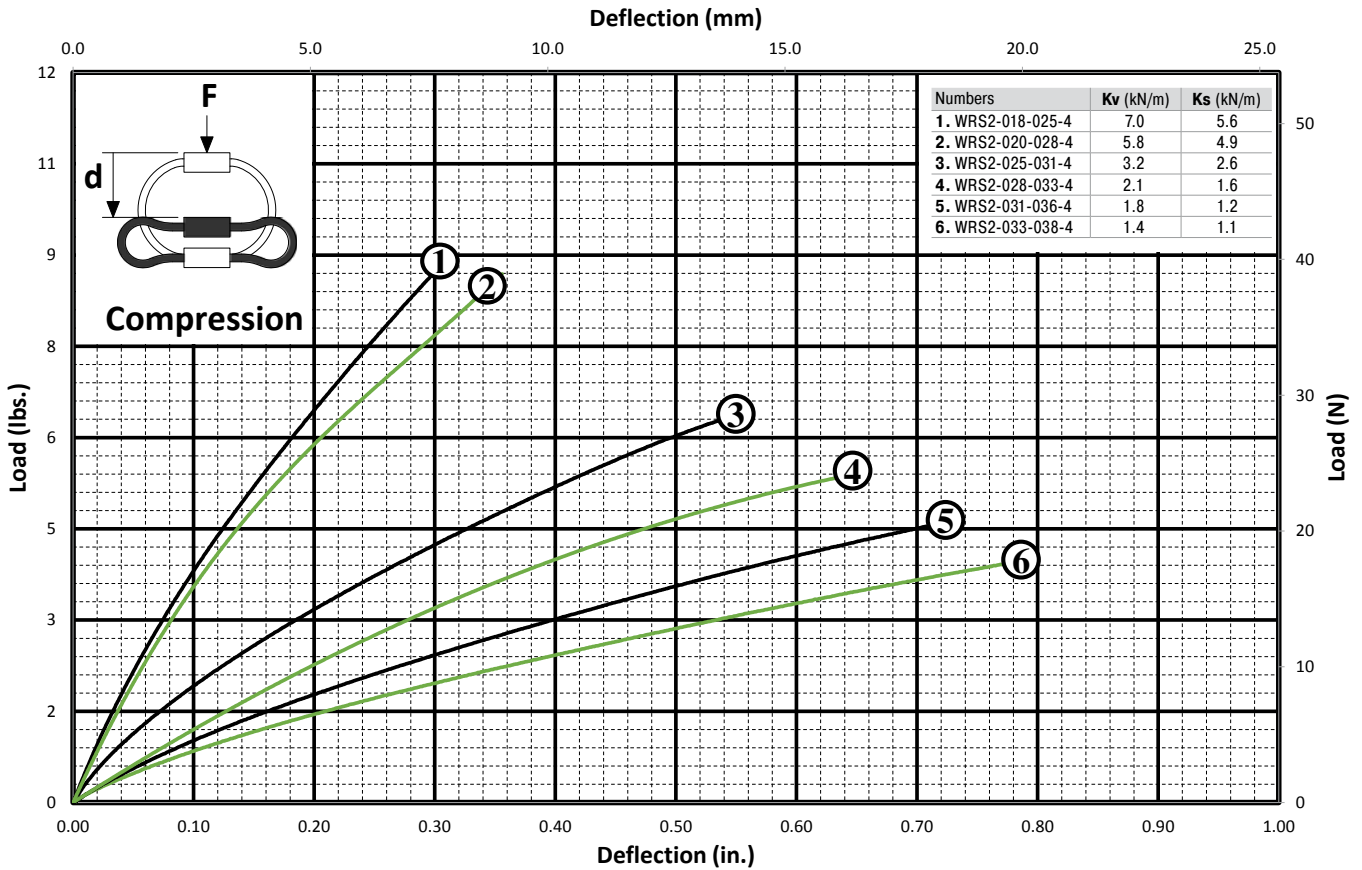

### Tension

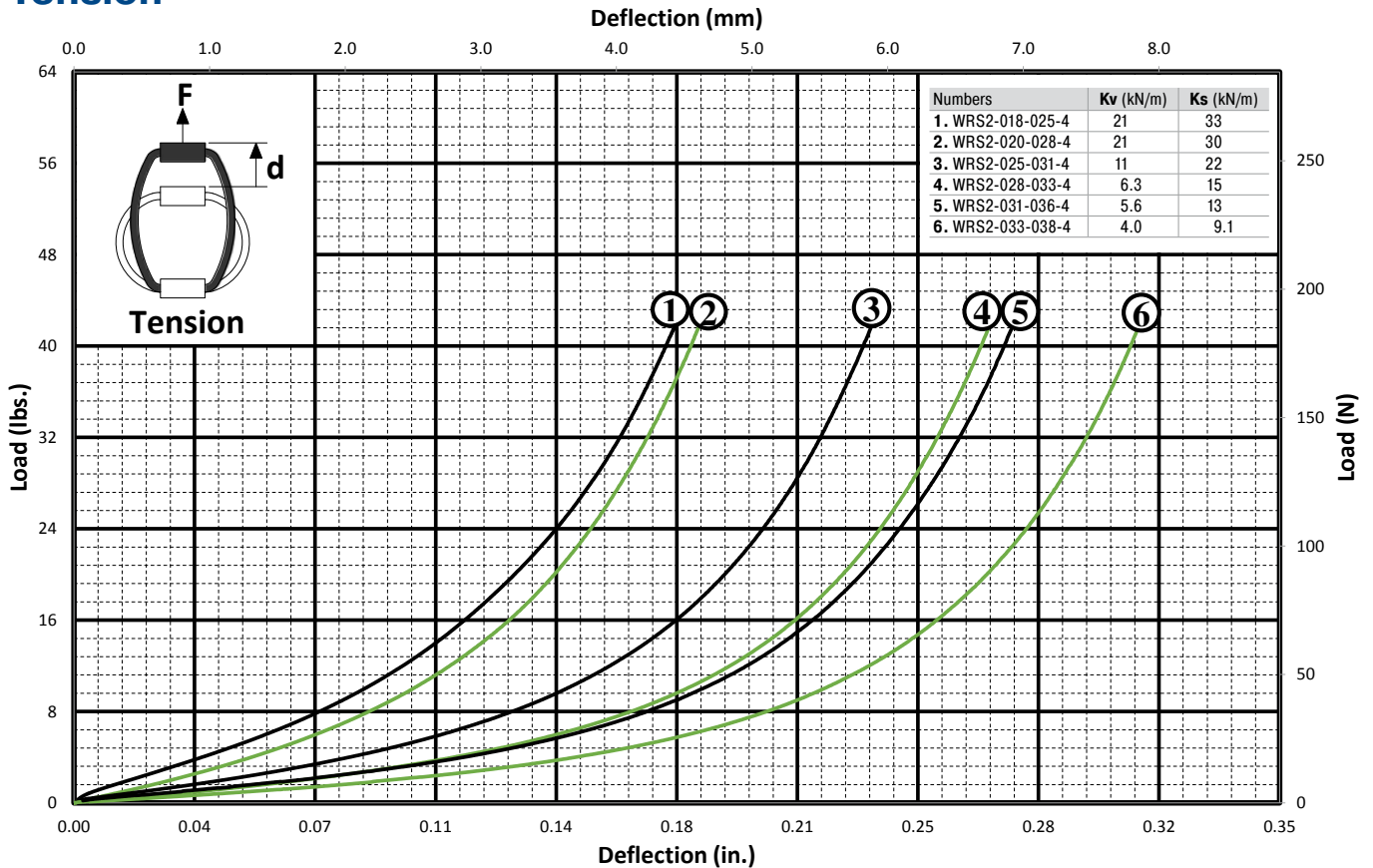

### Shear

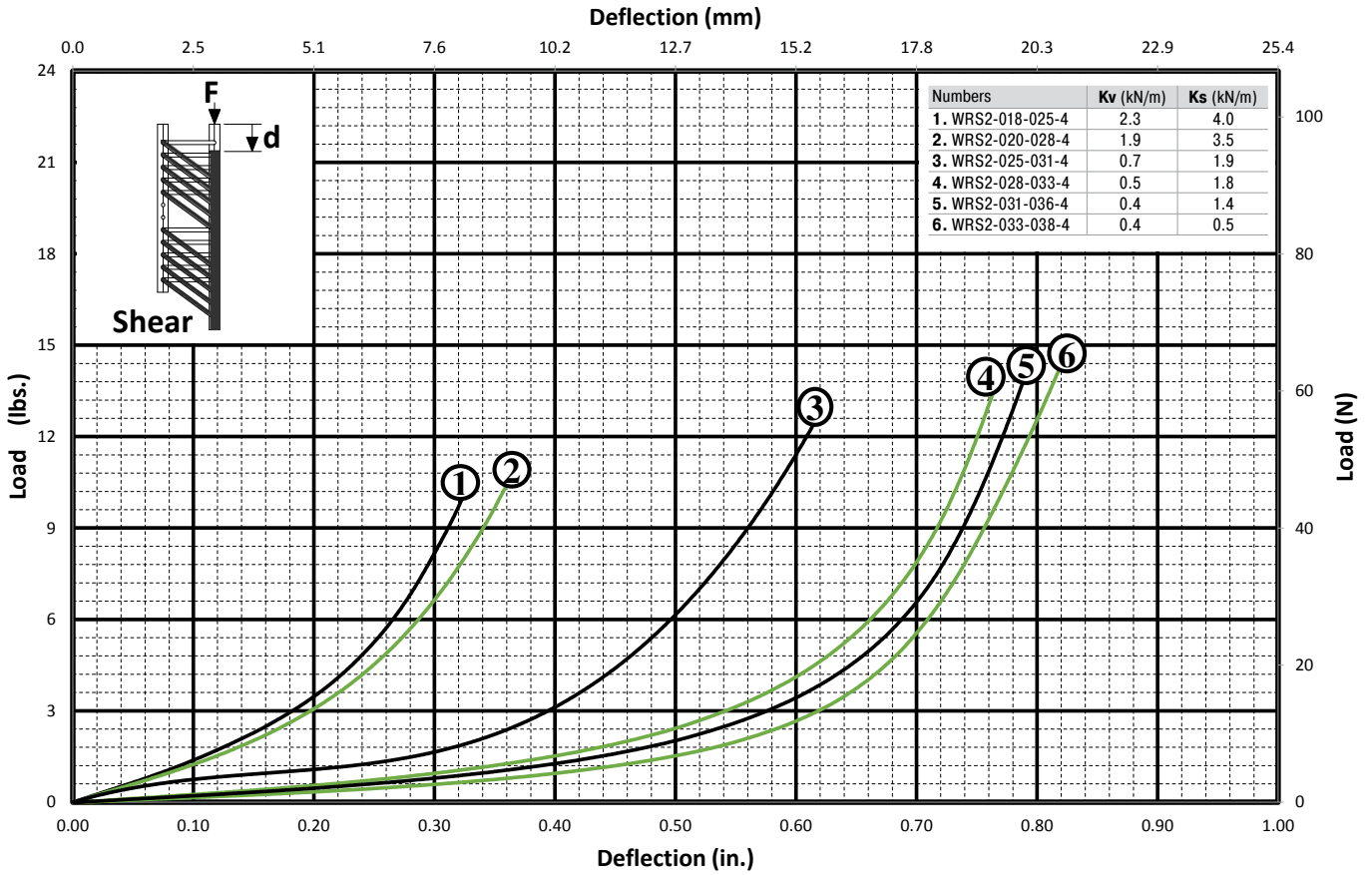

### Roll

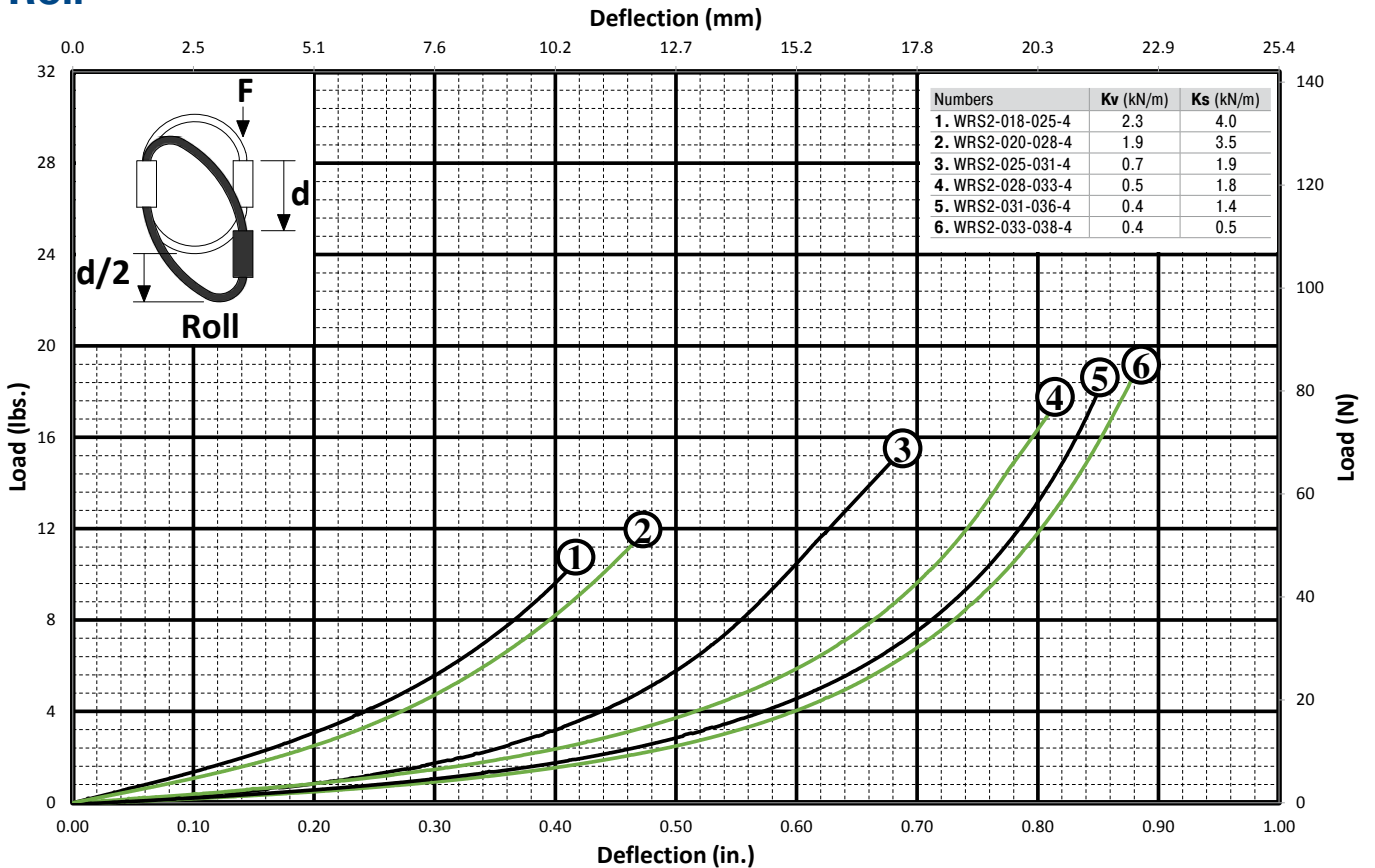

### 45° Compression/Roll

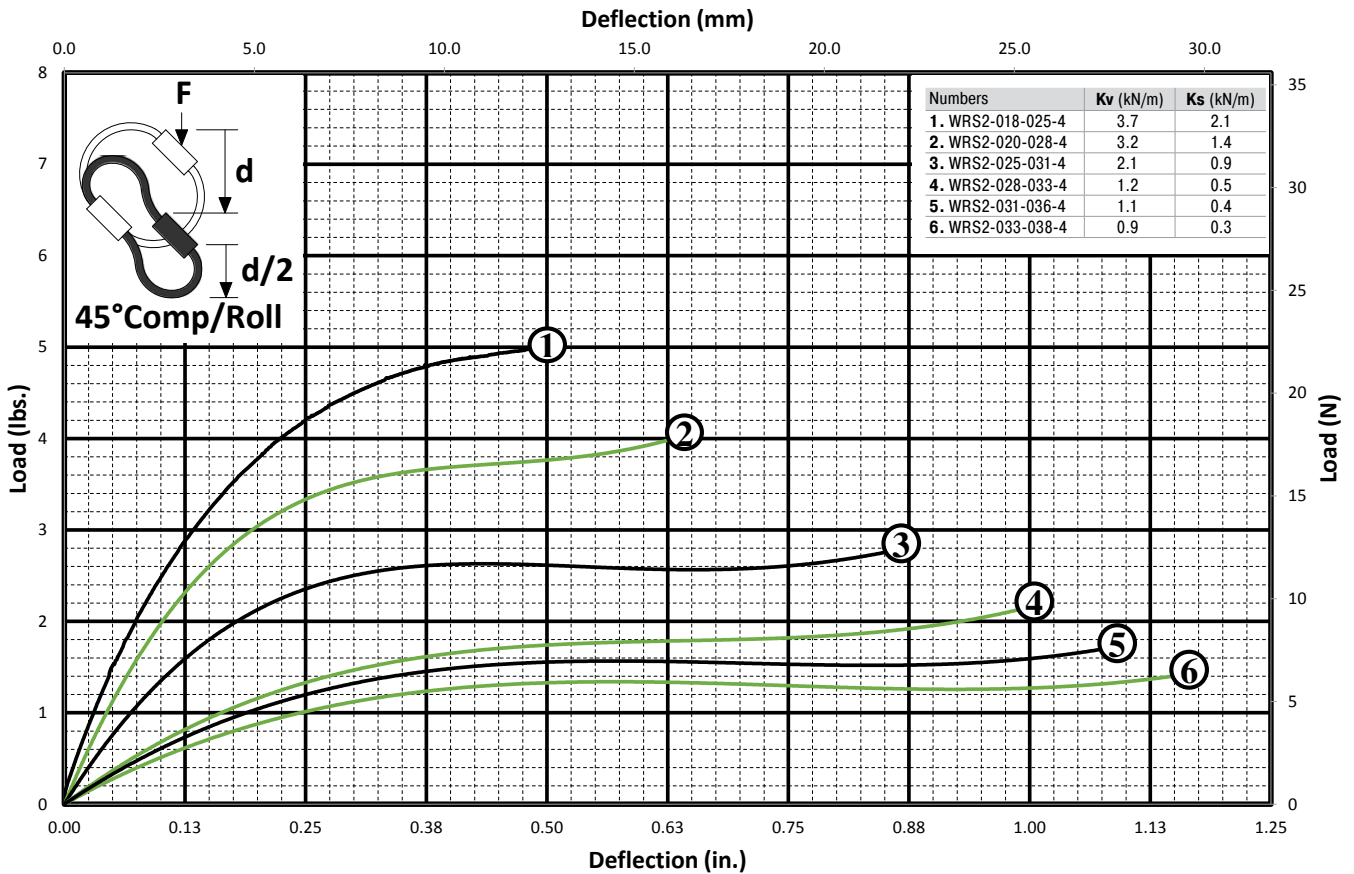

### 45° Tension/Roll

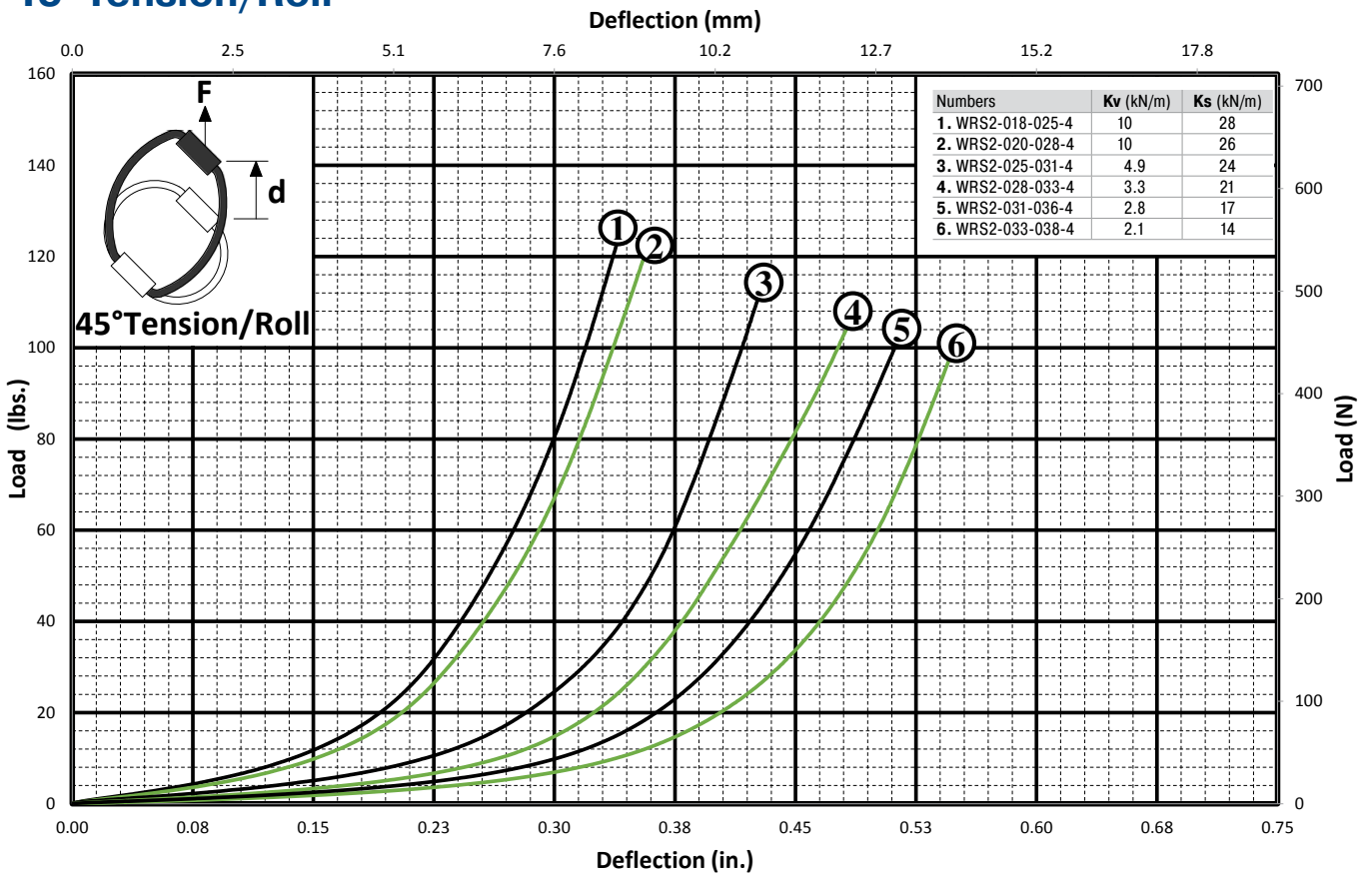

Product also available in stainless steel



# WRS3

## Helical Isolator Short

2.38 mm (3/32") Diameter Cable



### Features

- Rugged all metal construction
- Fail safe construction
- Long life and maintenance free
- Three axis capability (6 dof)
- High damping: C/cc ≈ 0.15 to 0.20

### Operating temperature range

-130°C to +260°C

### Material

- Cable: 300 Series SS per MIL-W-83420 or RR-W-410
- Screws: 300 Series SS per MS51959-26
- Inserts: 300 Series SS (alum bars only)
- Retainer bars: Standard: 6061-T6 Alum alloy/ Chem film IAW MIL-DTL-5541, TYPE II, Class 3

### Note

- Mounting hole tolerances: ±0.25 mm
- Add 0.04 kg to Isolator weight for all stainless steel versions

### On request

Special materials, size, mounting holes, finish, etc. available

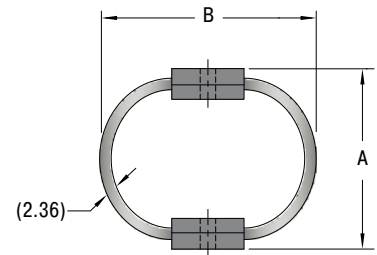
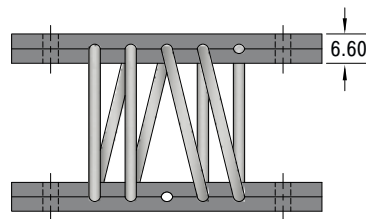
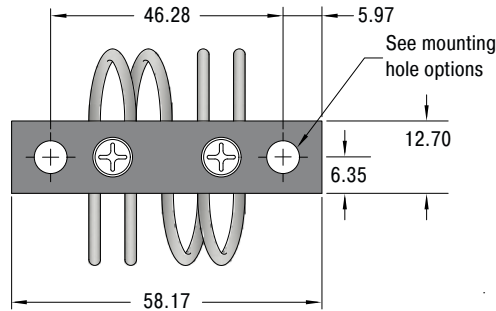

### Performance

TYPEN	A (+/- 0.8) mm	B mm	Compression			Shear/Roll (Average)			Weight kg
			Kv (Vibe) kN/m	Ks (Shock) kN/m	Deflection max. mm	Kv (Vibe) kN/m	Ks (Shock) kN/m	Deflection max. mm	
WRS3-023-028-4	22.9	27.9	29	25	7.6	9.8	13	7.6	0.027
WRS3-025-031-4	25.4	30.5	20	18	10.2	6.8	11	10.2	0.028
WRS3-028-034-4	27.9	33.5	14	12	12.7	3.9	7.2	12.7	0.030
WRS3-033-038-4	33.0	38.1	6.7	5.6	17.8	2.1	3.2	17.8	0.031
WRS3-036-041-4	35.6	40.6	6.0	4.9	20.3	1.8	2.8	20.3	0.032
WRS3-038-043-4	38.1	43.2	4.6	3.5	22.9	1.2	2.1	22.9	0.034

### Ordering Example

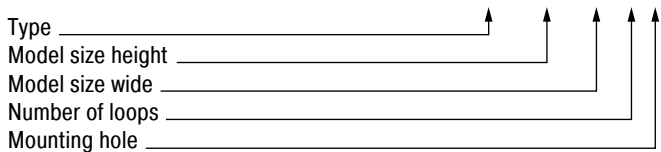

Mounting Hole Options	
<p>A</p>	<p>D</p>
<p>B</p>	<p>E</p>
<p>C</p>	<p>F</p>

Issue 07.2020 – Specifications subject to change



### Compression

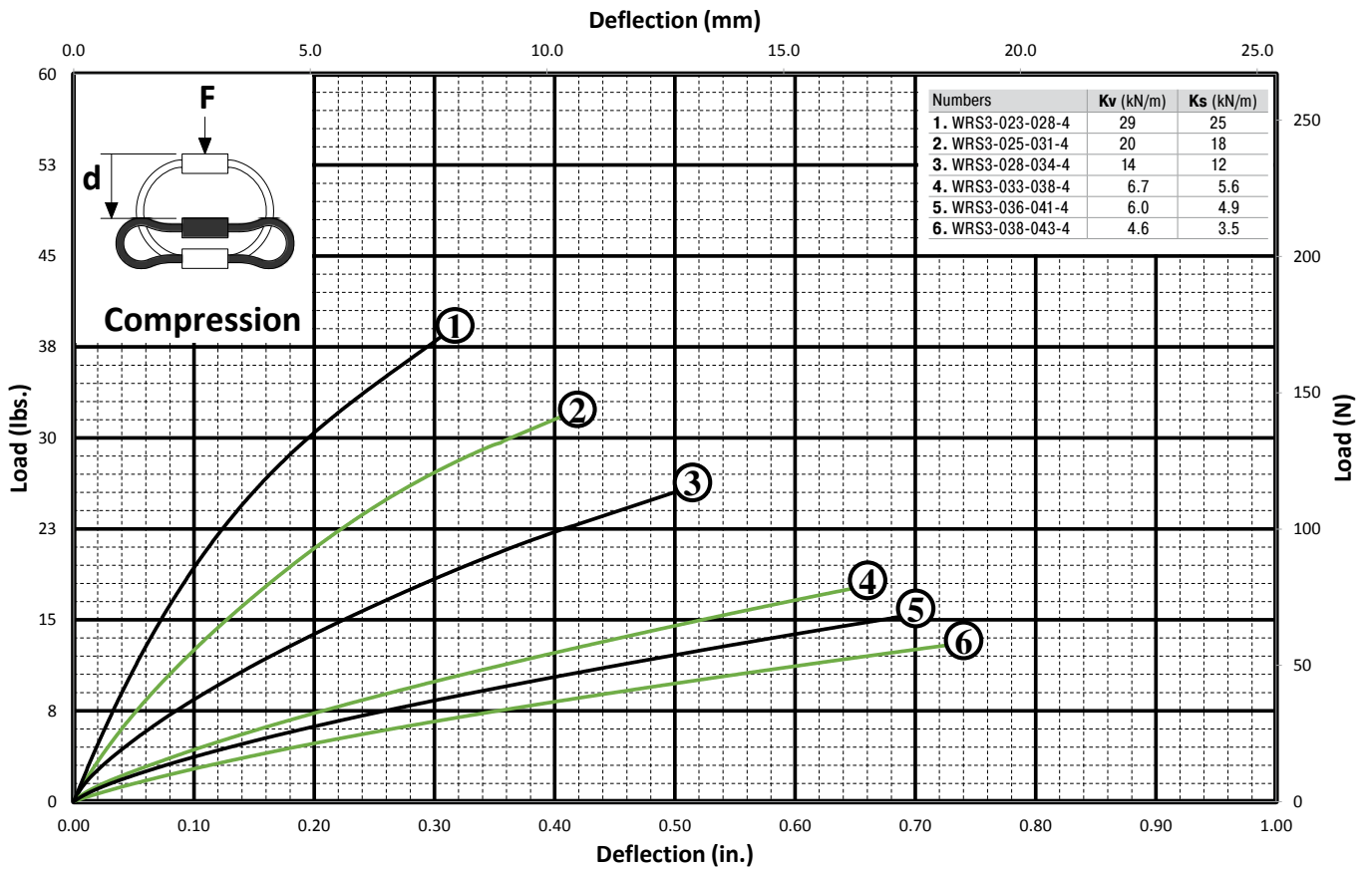

### Tension

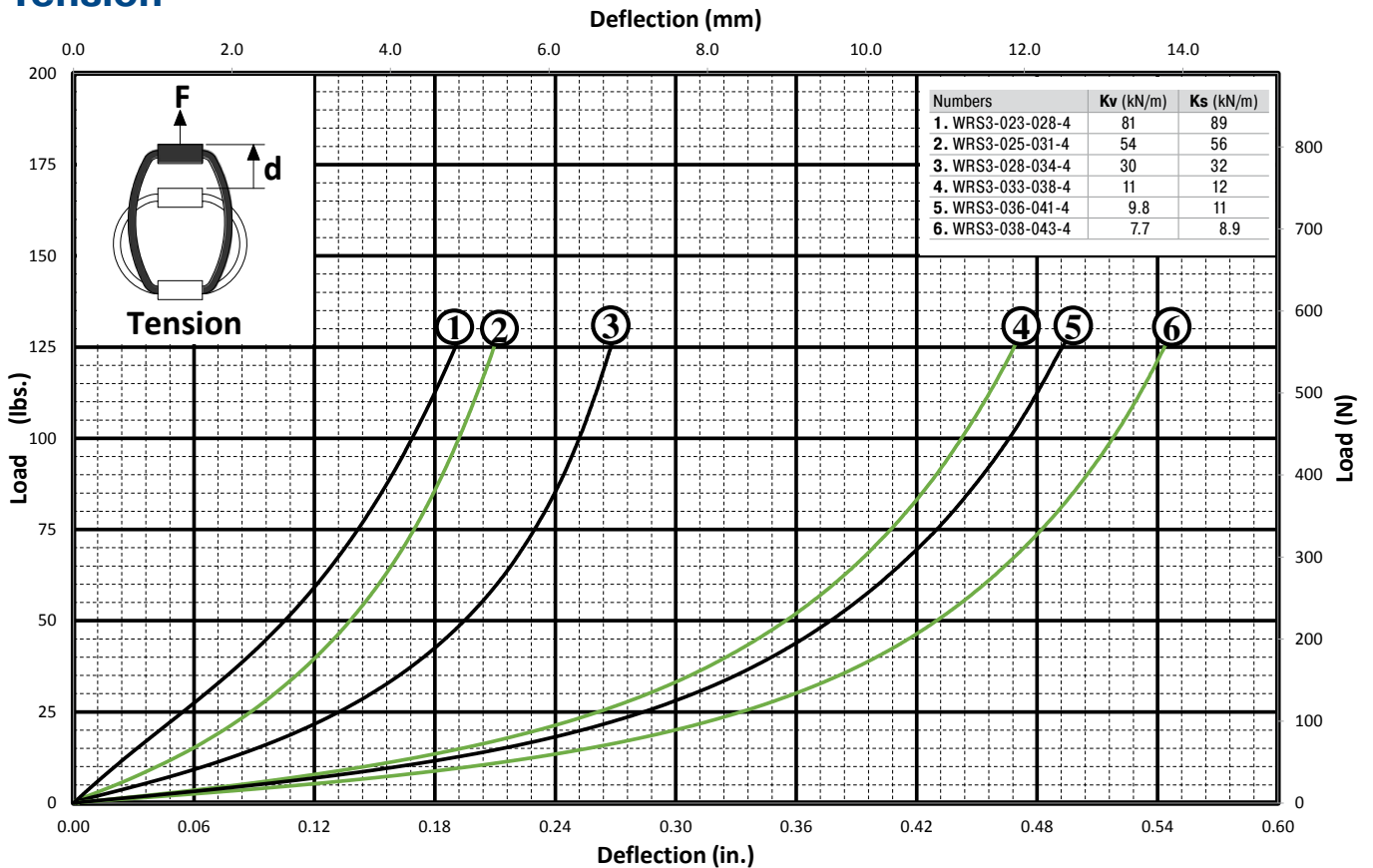

Helical Isolator Short, 2.38 mm (3/32") Diameter Cable

### Shear

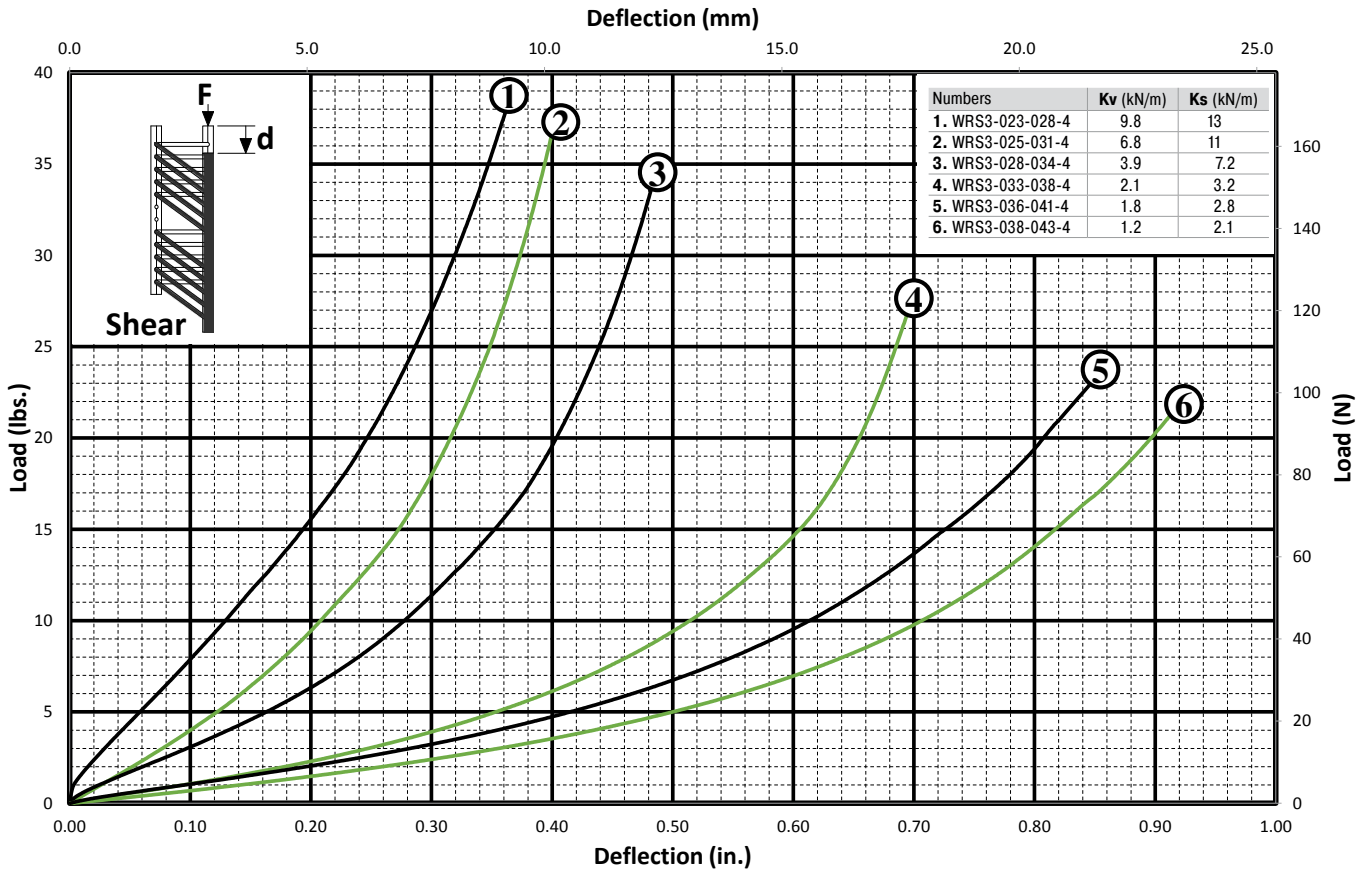

### Roll

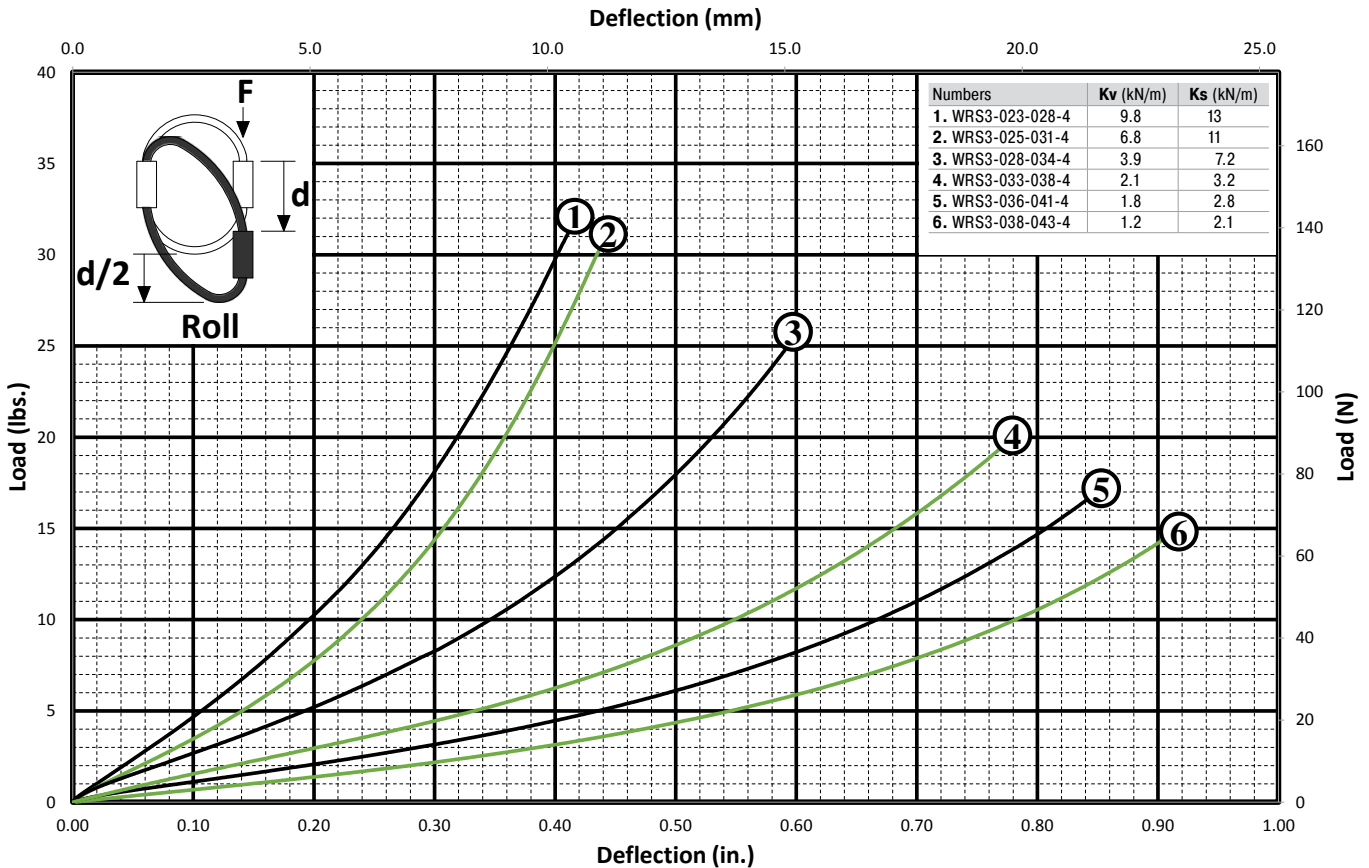

### 45° Compression/Roll

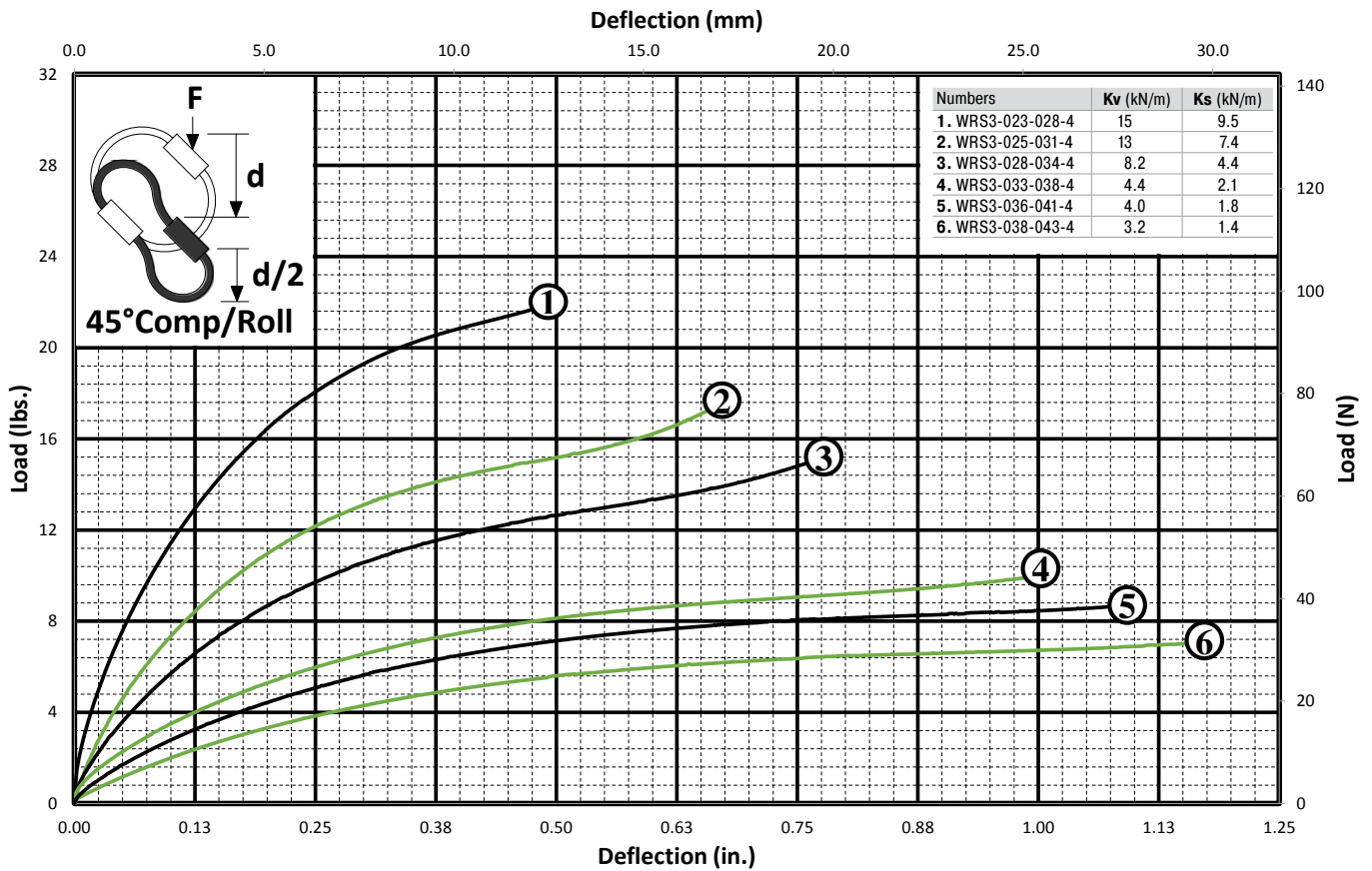

### 45° Tension/Roll

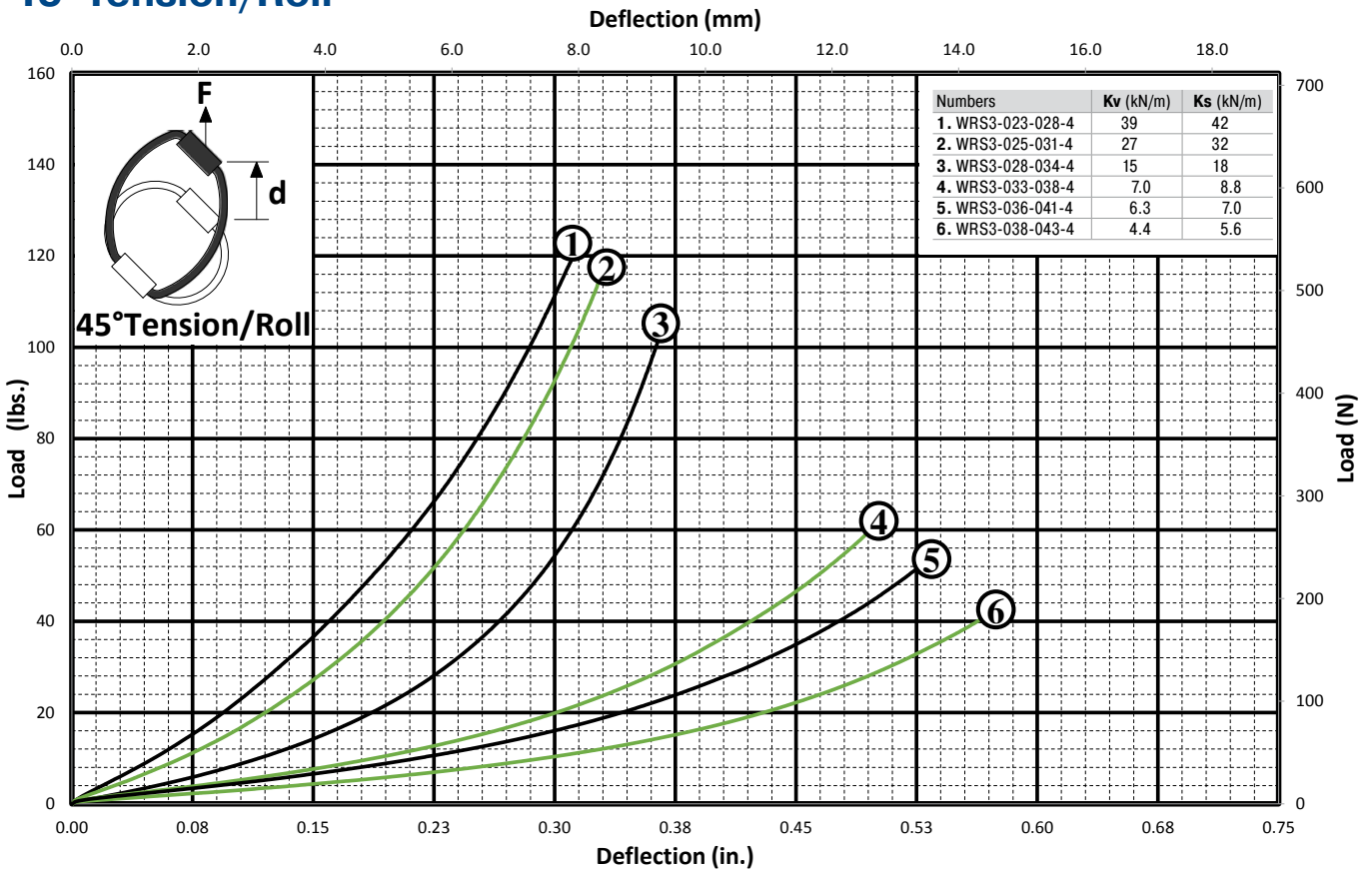

Issue 07.2020 – Specifications subject to change

Product also available in stainless steel



# WRS4

## Helical Isolator Short

### 3.18 mm (1/8") Diameter Cable

#### Features

- Rugged all metal construction
- Fail safe construction
- Long life and maintenance free
- Three axis capability (6 dof)
- High damping: C/cc ≈ 0.15 to 0.20

#### Operating temperature range

-130°C to +260°C

#### Material

- Cable: 300 Series SS per MIL-W-83420 or RR-W-410
- Screws: 300 Series SS per MS51959-42
- Inserts: 300 Series SS (alum bars only)
- Retainer bars: Standard: 6061-T6 Alum alloy/ Chem film IAW MIL-DTL-5541, TYPE II, Class 3

#### Note

- Mounting hole tolerances: ±0.25 mm
- Add 0.06 kg to Isolator weight for all stainless steel versions

#### On request

Special materials, size, mounting holes, finish, etc. available

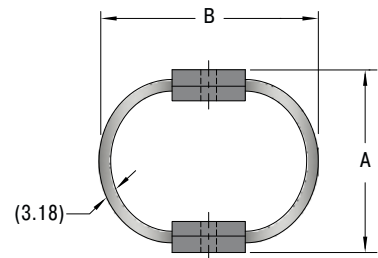
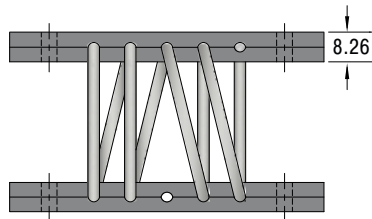
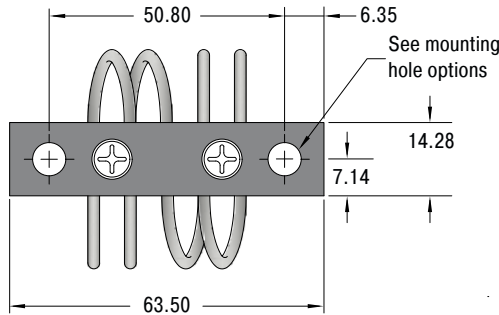

#### Performance

TYPEN	A (+/- 0.8) mm	B mm	Compression			Shear/Roll (Average)			Weight kg
			Kv (Vibe) kN/m	Ks (Shock) kN/m	Deflection max. mm	Kv (Vibe) kN/m	Ks (Shock) kN/m	Deflection max. mm	
WRS4-028-036-4	27.9	35.6	35	32	8.9	13	15	8.9	0.045
WRS4-031-038-4	30.5	38.1	34	29	11.4	11	14	11.4	0.045
WRS4-033-041-4	33.0	40.6	27	21	14.0	8.4	12	14.0	0.048
WRS4-036-043-4	35.6	43.2	20	17	16.5	5.8	8.8	16.5	0.049
WRS4-038-046-4	38.1	45.7	16	13	19.1	5.3	7.9	19.1	0.050
WRS4-041-048-4	40.6	48.2	14	10	21.6	3.9	6.1	21.6	0.051

#### Ordering Example

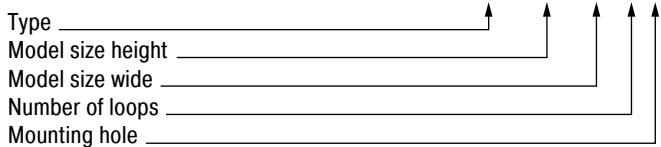

#### Mounting Hole Options

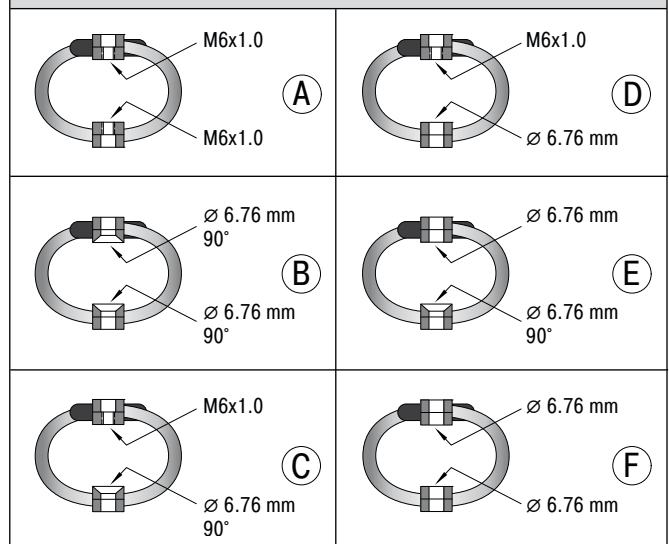

Issue 07.2020 – Specifications subject to change

### Compression

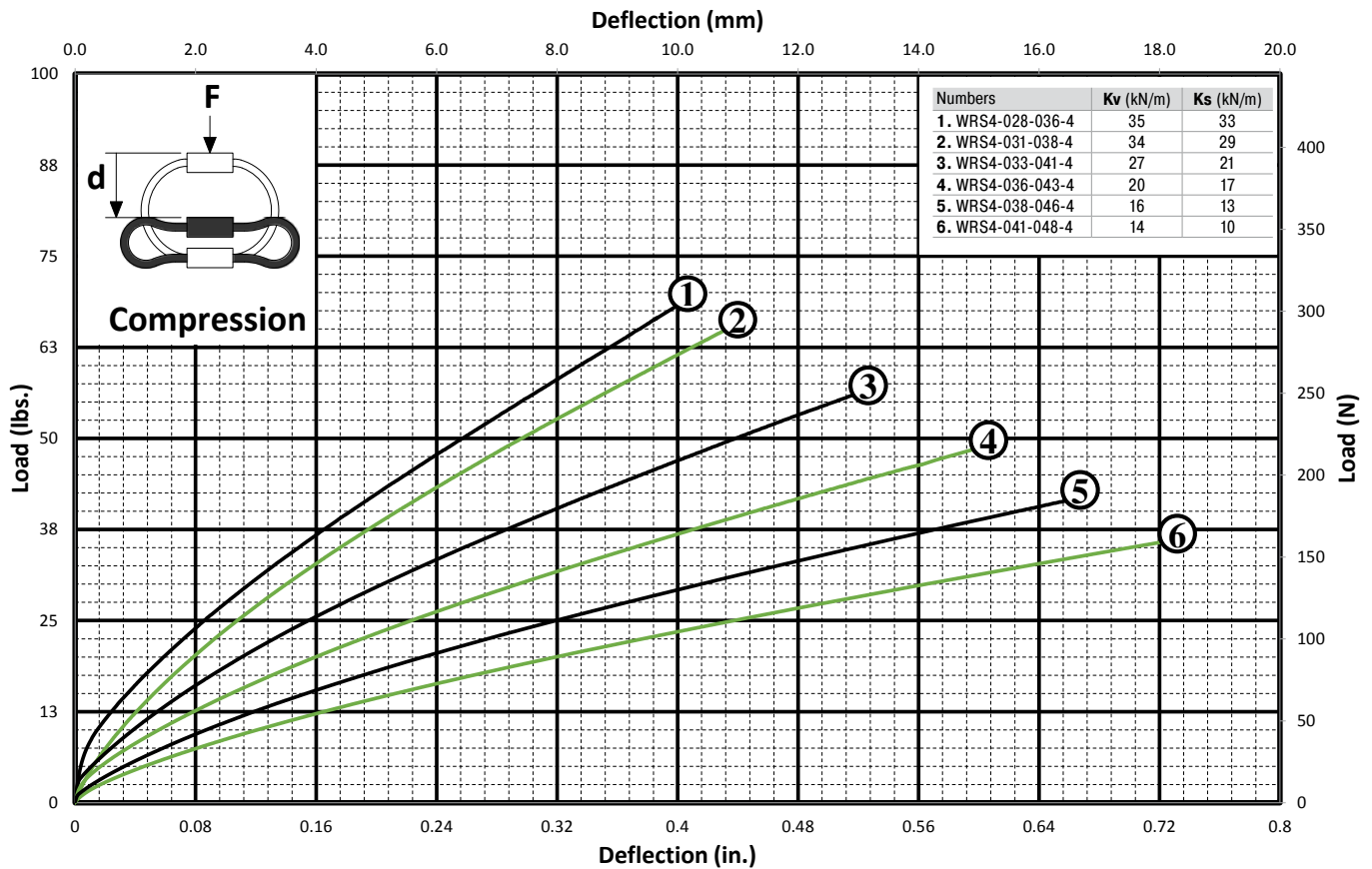

### Tension

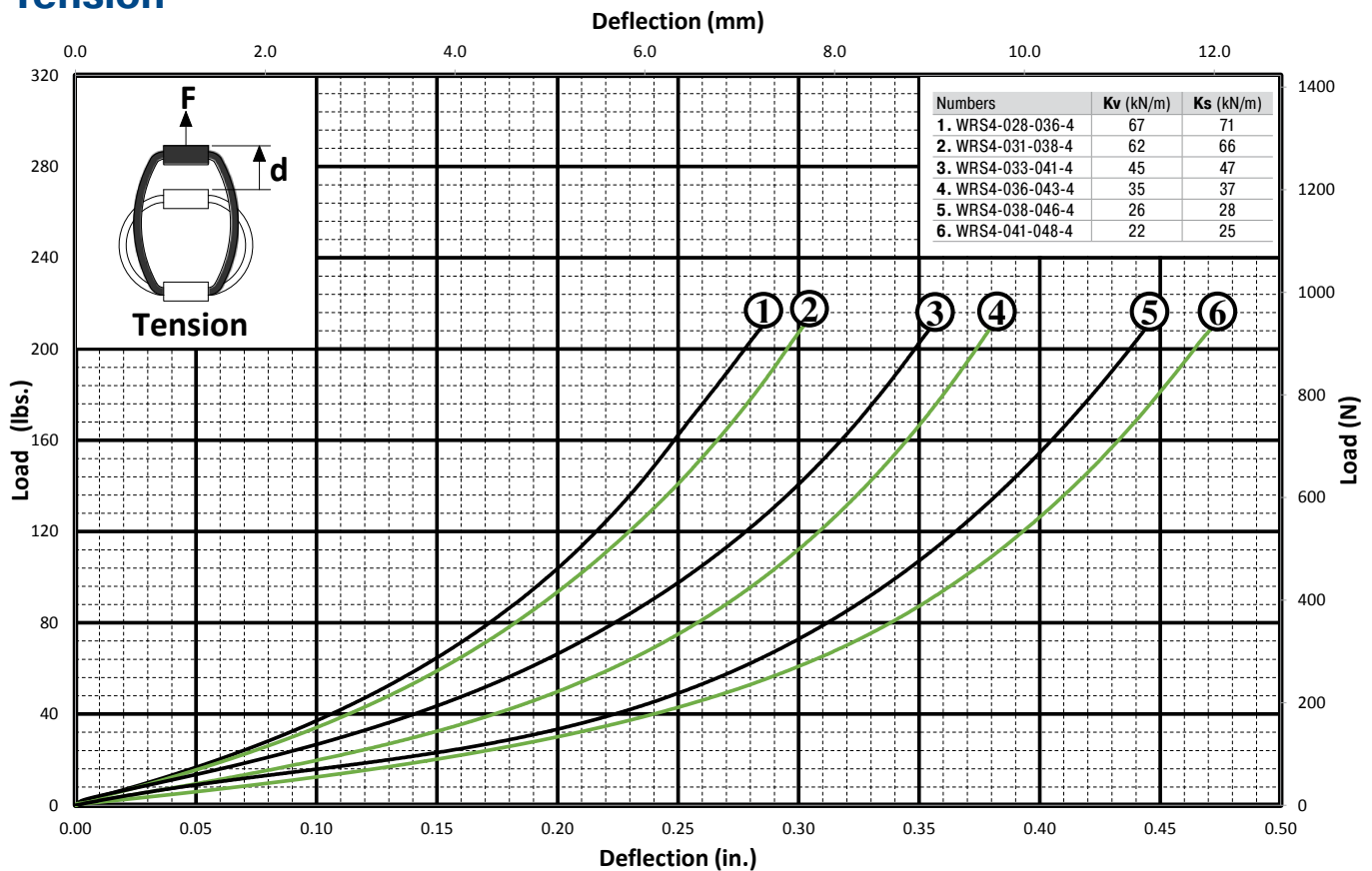



### Shear

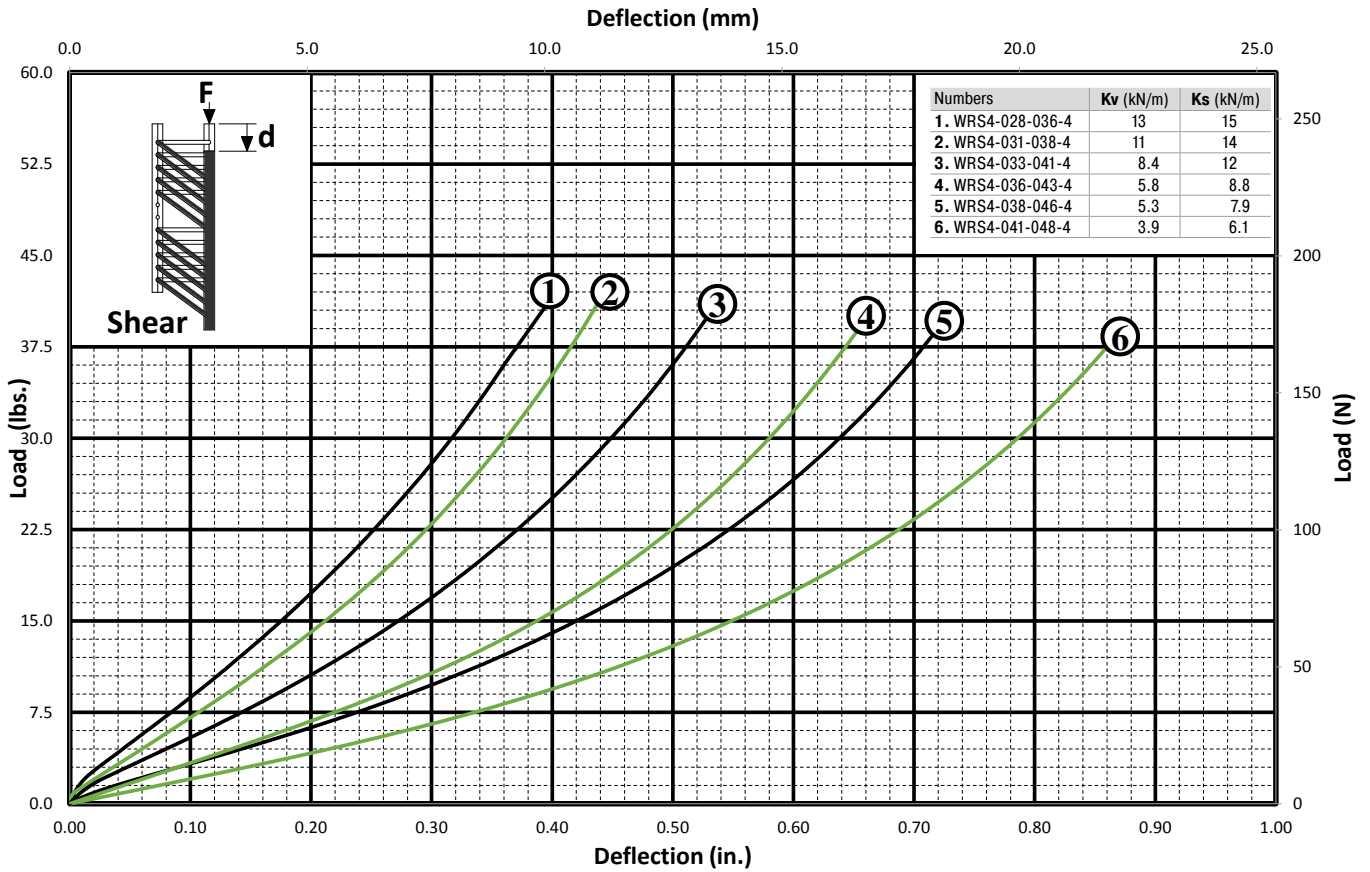

### Roll

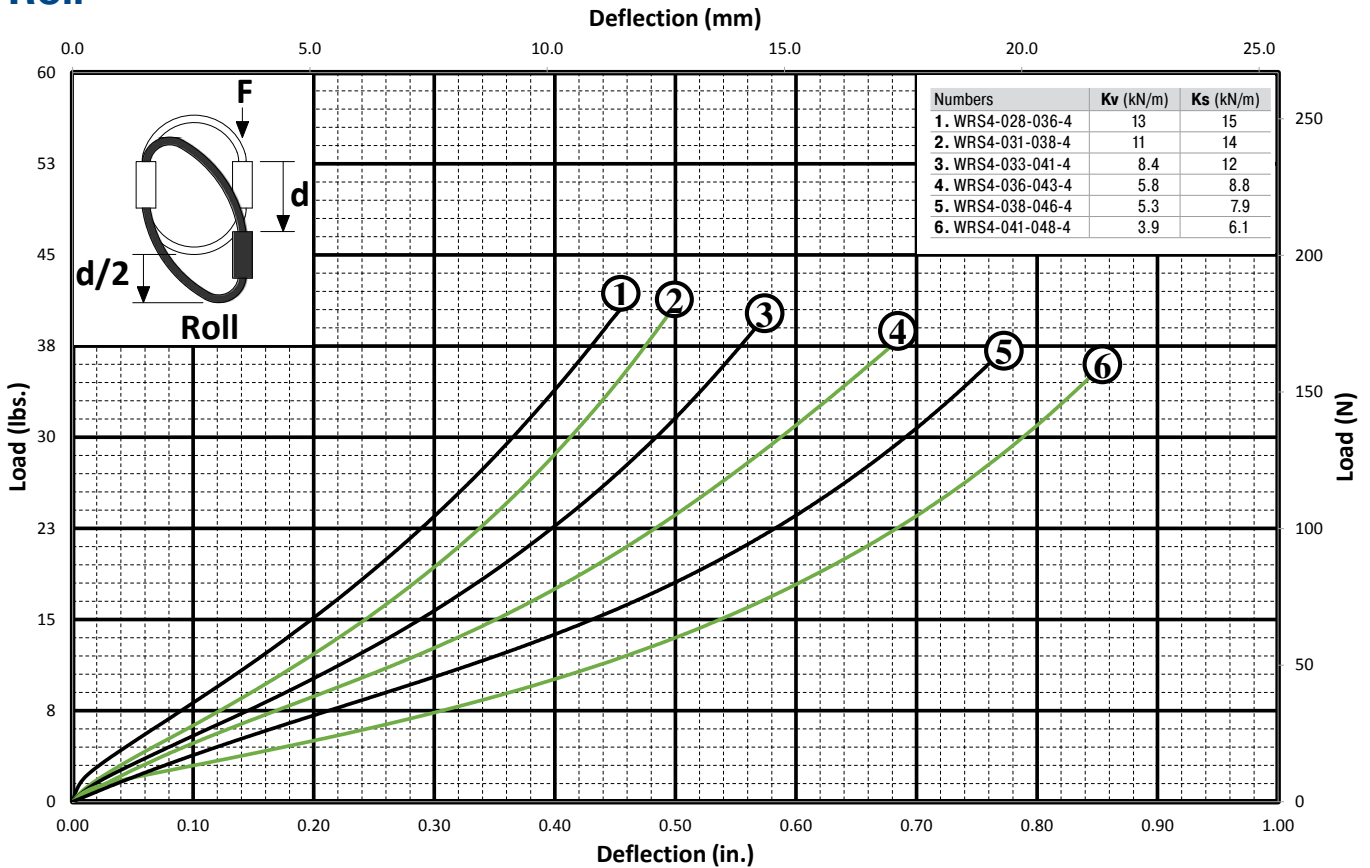

### 45° Compression/Roll

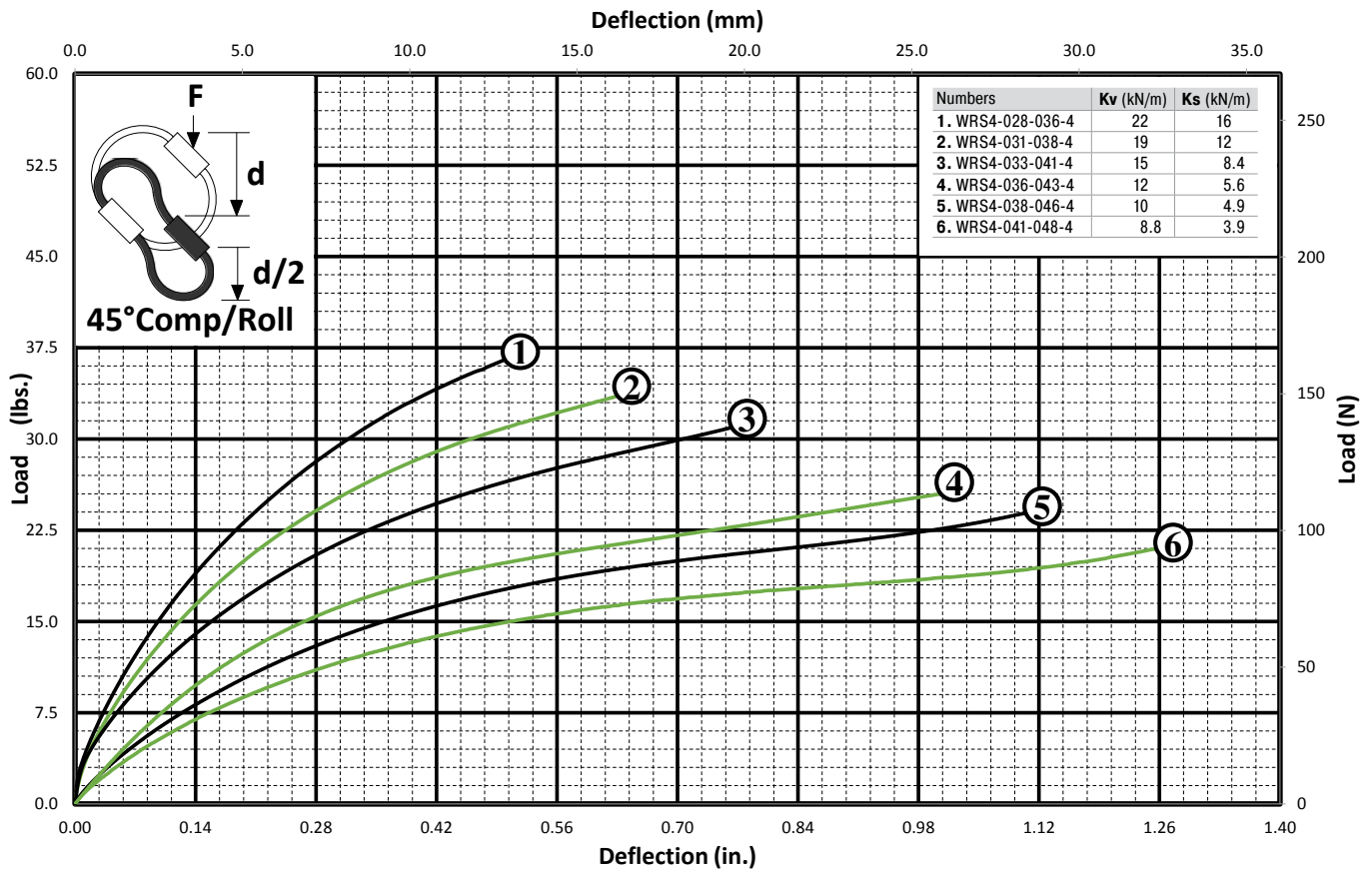

### 45° Tension/Roll

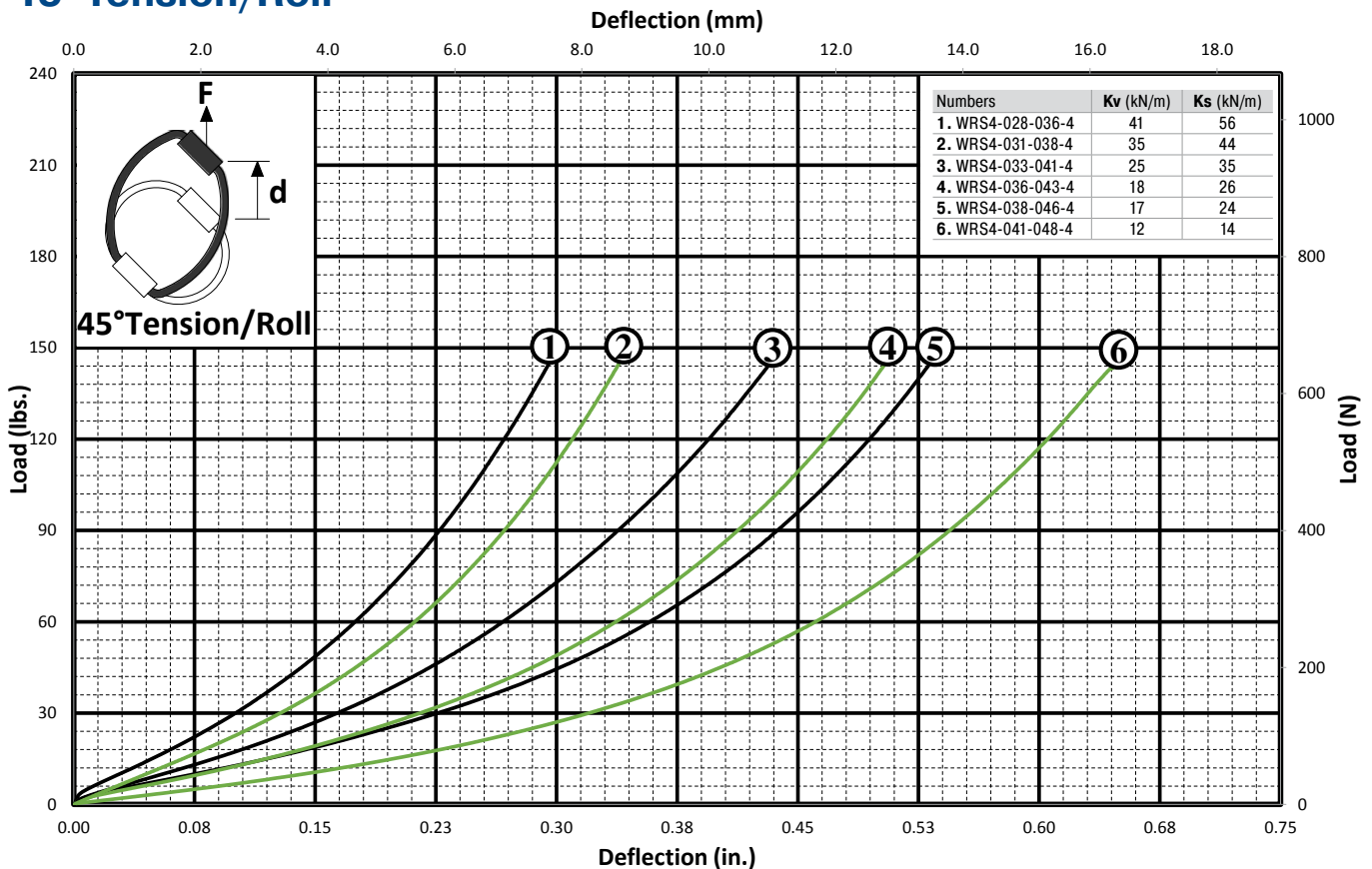

Issue 07.2020 – Specifications subject to change

Product also available in stainless steel



# WRS5

## Helical Isolator Short

3.97 mm (5/32") Diameter Cable



**Features**

- Rugged all metal construction
- Fail safe construction
- Long life and maintenance free
- Three axis capability (6 dof)
- High damping: C/cc ≈ 0.15 to 0.20

**Operating temperature range**

-130°C to +260°C

**Material**

- Cable: 300 Series SS per MIL-W-83420 or RR-W-410
- Screws: 300 Series SS per MS51959-42
- Inserts: 300 Series SS (alum bars only)
- Retainer bars: Standard: 6061-T6 Alum alloy/ Chem film IAW MIL-DTL-5541, TYPE II, Class 3

**Note**

- Mounting hole tolerances: ±0.25 mm
- Add 0.06 kg to Isolator weight for all stainless steel versions

**On request**

Special materials, size, mounting holes, finish, etc. available

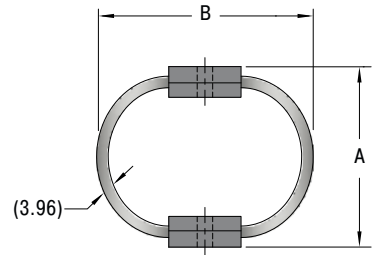
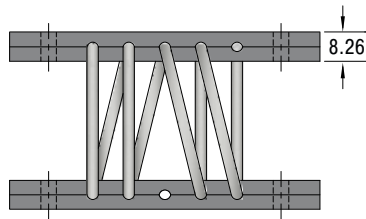
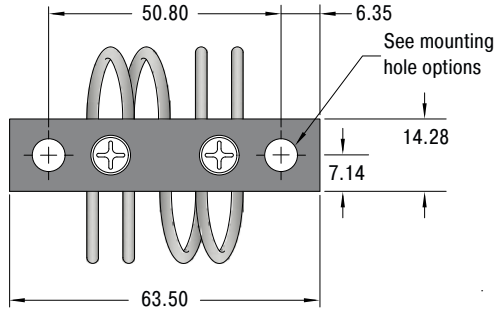

**Performance**

TYPEN	A (+/- 0.8) mm	B mm	Compression			Shear/Roll (Average)			Weight kg
			Kv (Vibe) kN/m	Ks (Shock) kN/m	Deflection max. mm	Kv (Vibe) kN/m	Ks (Shock) kN/m	Deflection max. mm	
WRS5-028-036-4	27.9	35.6	91	84	8.9	33	39	8.9	0.052
WRS5-031-038-4	30.5	38.1	79	70	11.4	25	30	11.4	0.054
WRS5-033-041-4	33.0	40.6	55	47	14.0	17	20	14.0	0.059
WRS5-036-043-4	35.6	43.2	47	37	16.5	13	17	16.5	0.059
WRS5-038-046-4	38.1	45.7	36	29	19.1	8.9	14	19.1	0.061
WRS5-041-048-4	40.6	48.2	27	21	21.6	7.4	11	21.6	0.061

**Ordering Example**

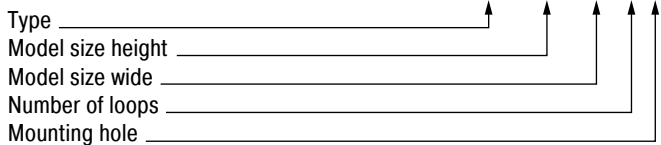

Mounting Hole Options	
<p>A</p>	<p>D</p>
<p>B</p>	<p>E</p>
<p>C</p>	<p>F</p>

Issue 07.2020 – Specifications subject to change

### Compression

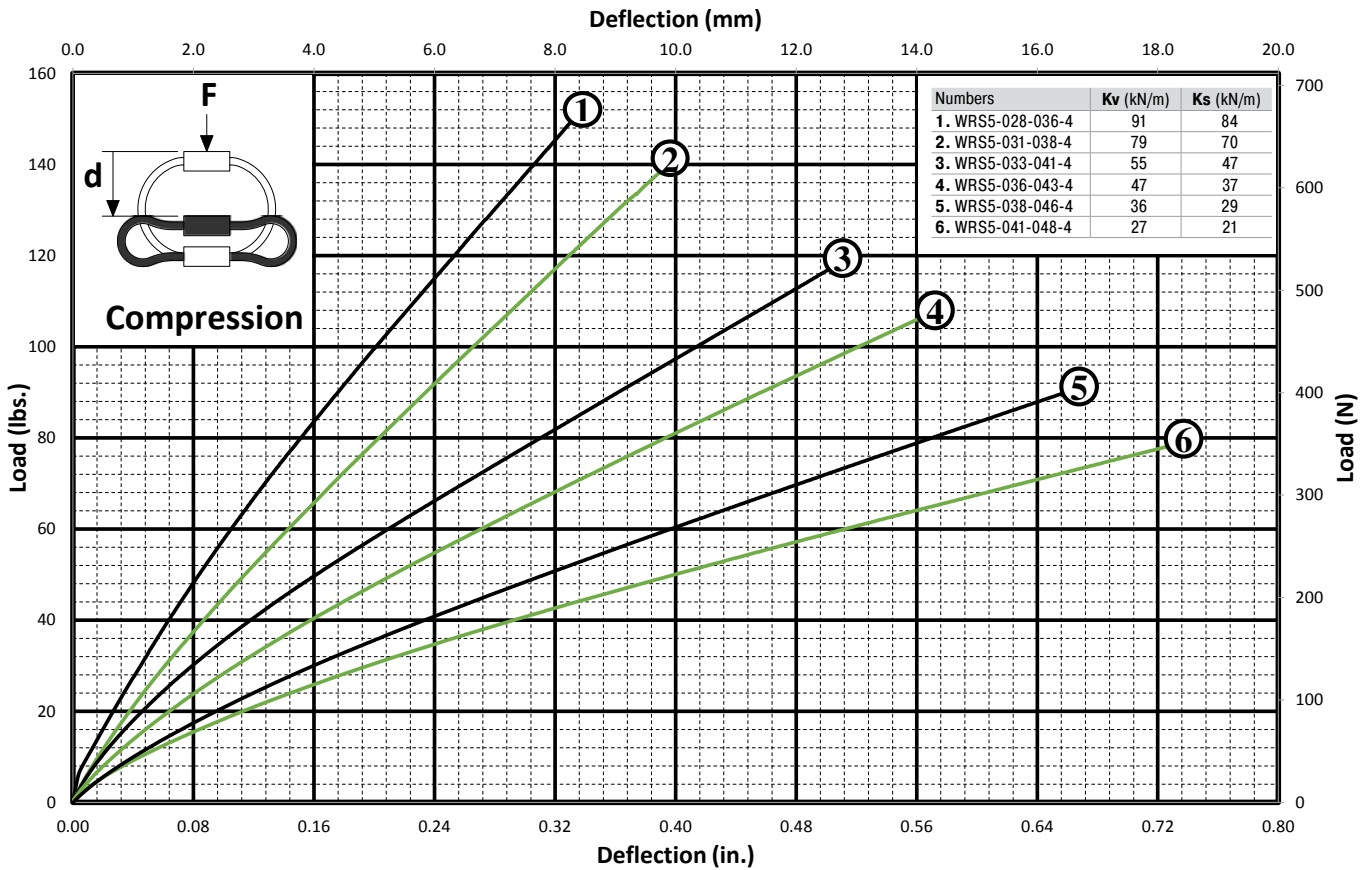

### Tension

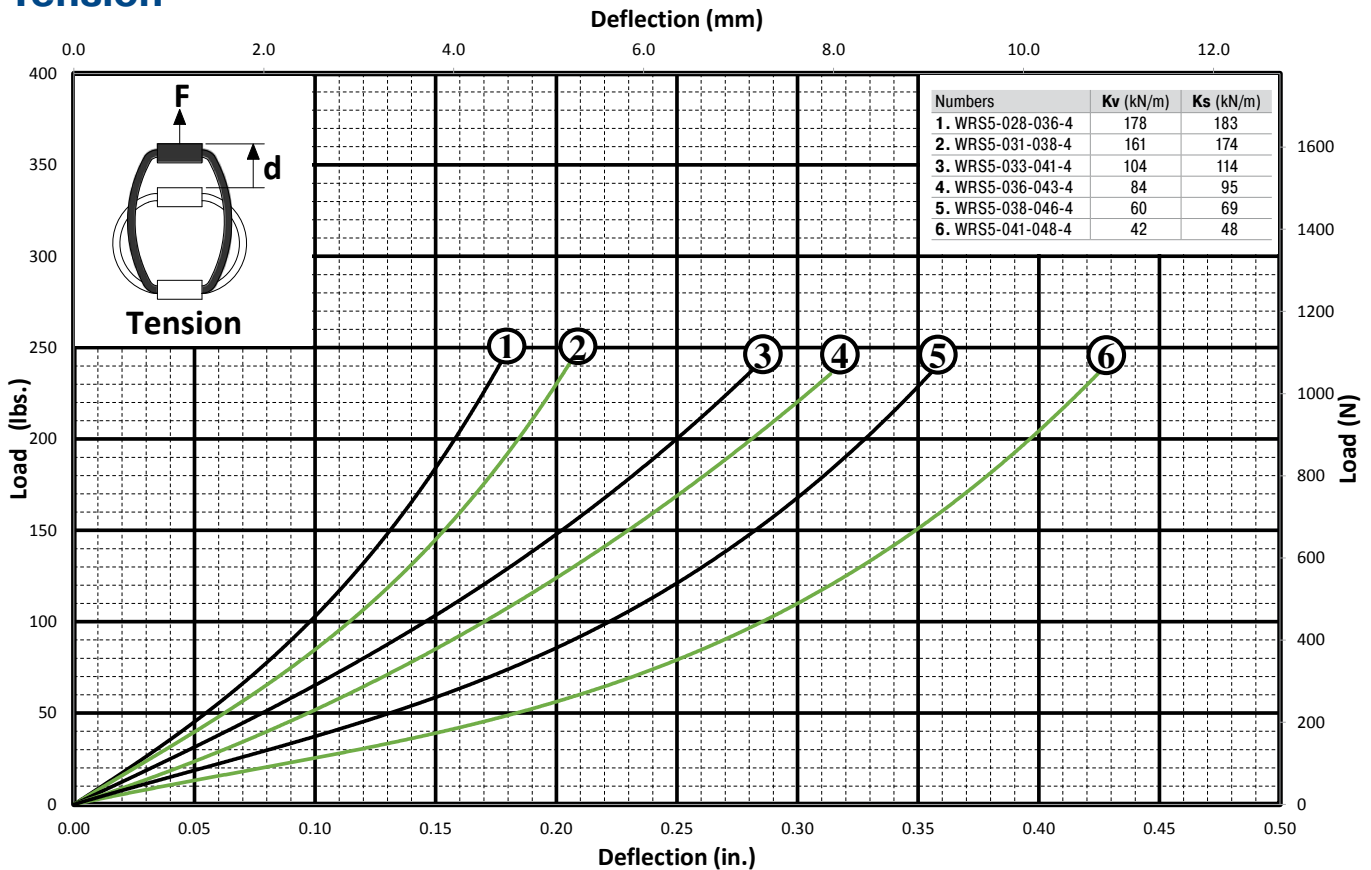

Issue 07.2020 – Specifications subject to change

Helical Isolator Short, 3.97 mm (5/32") Diameter Cable

### Shear

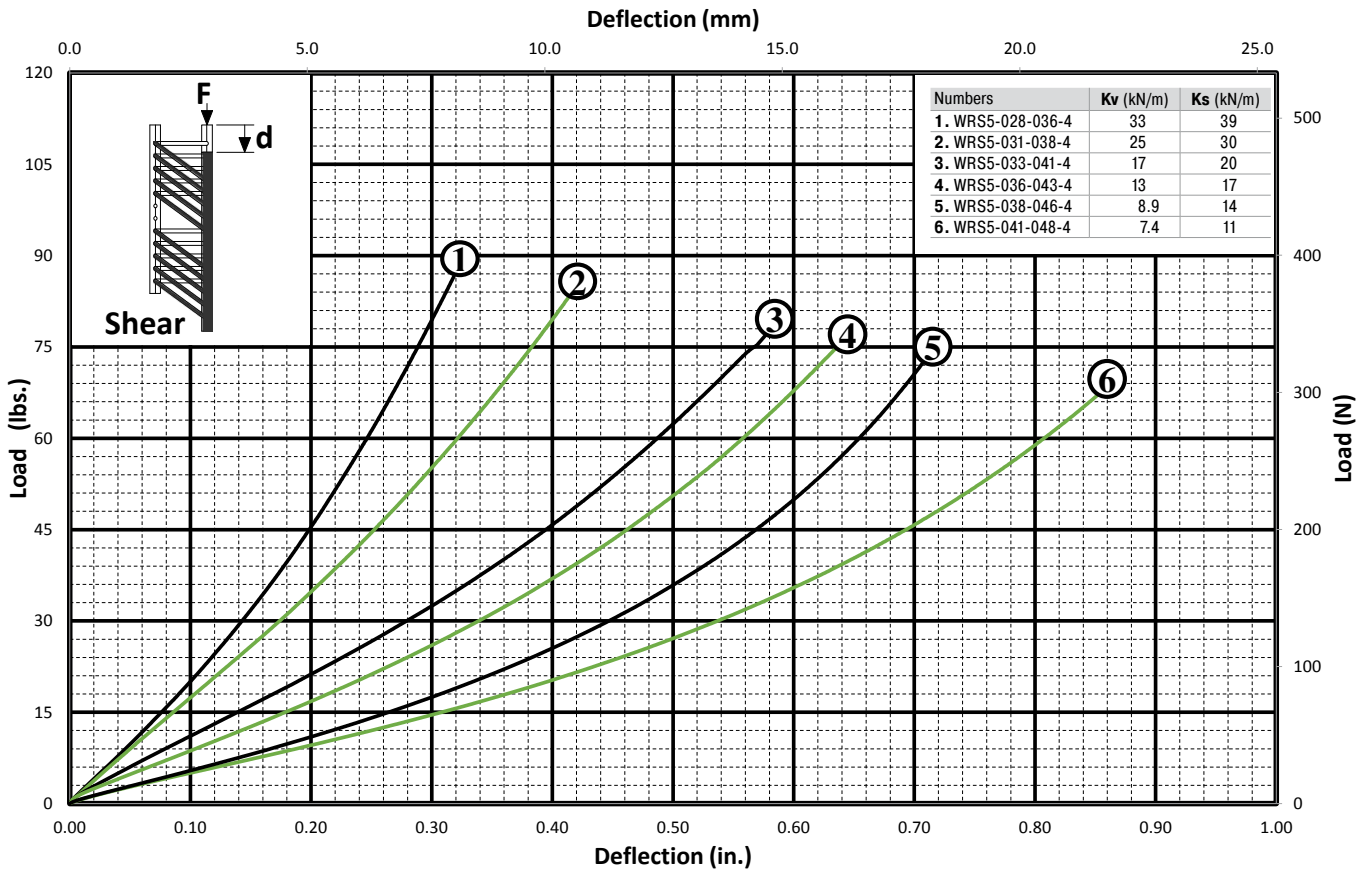

### Roll

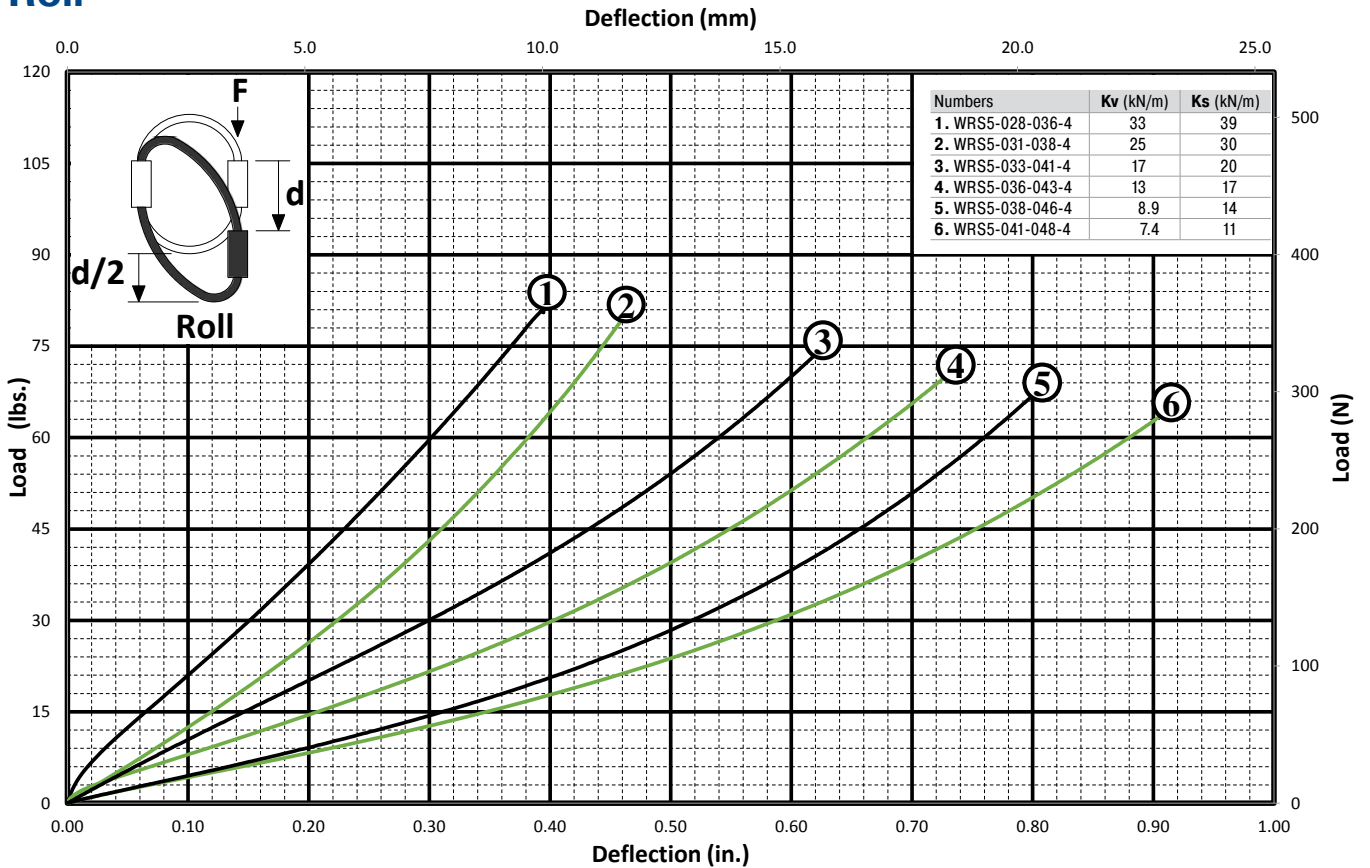

Issue 07.2020 – Specifications subject to change



### 45° Compression/Roll

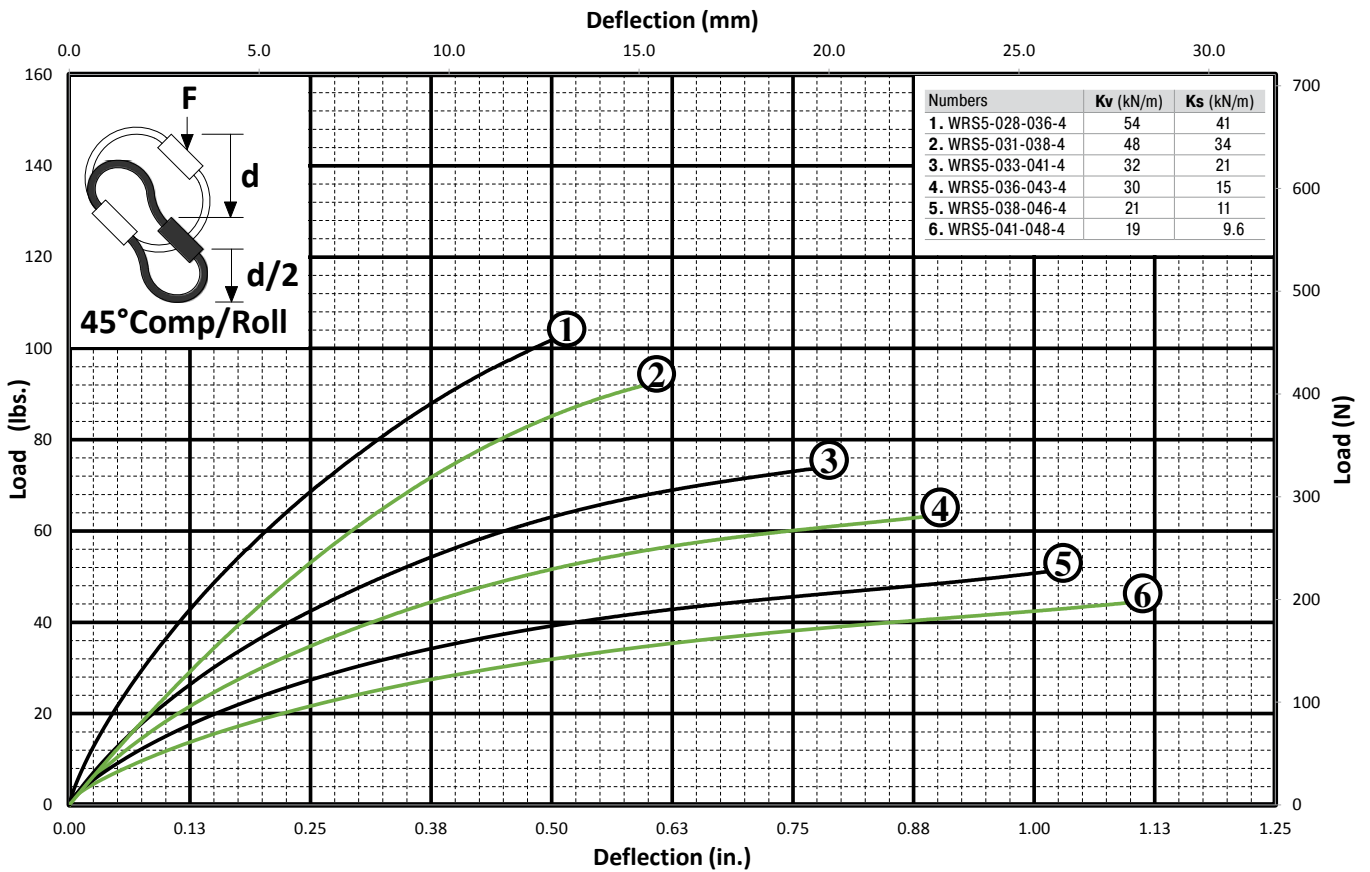

### 45° Tension/Roll

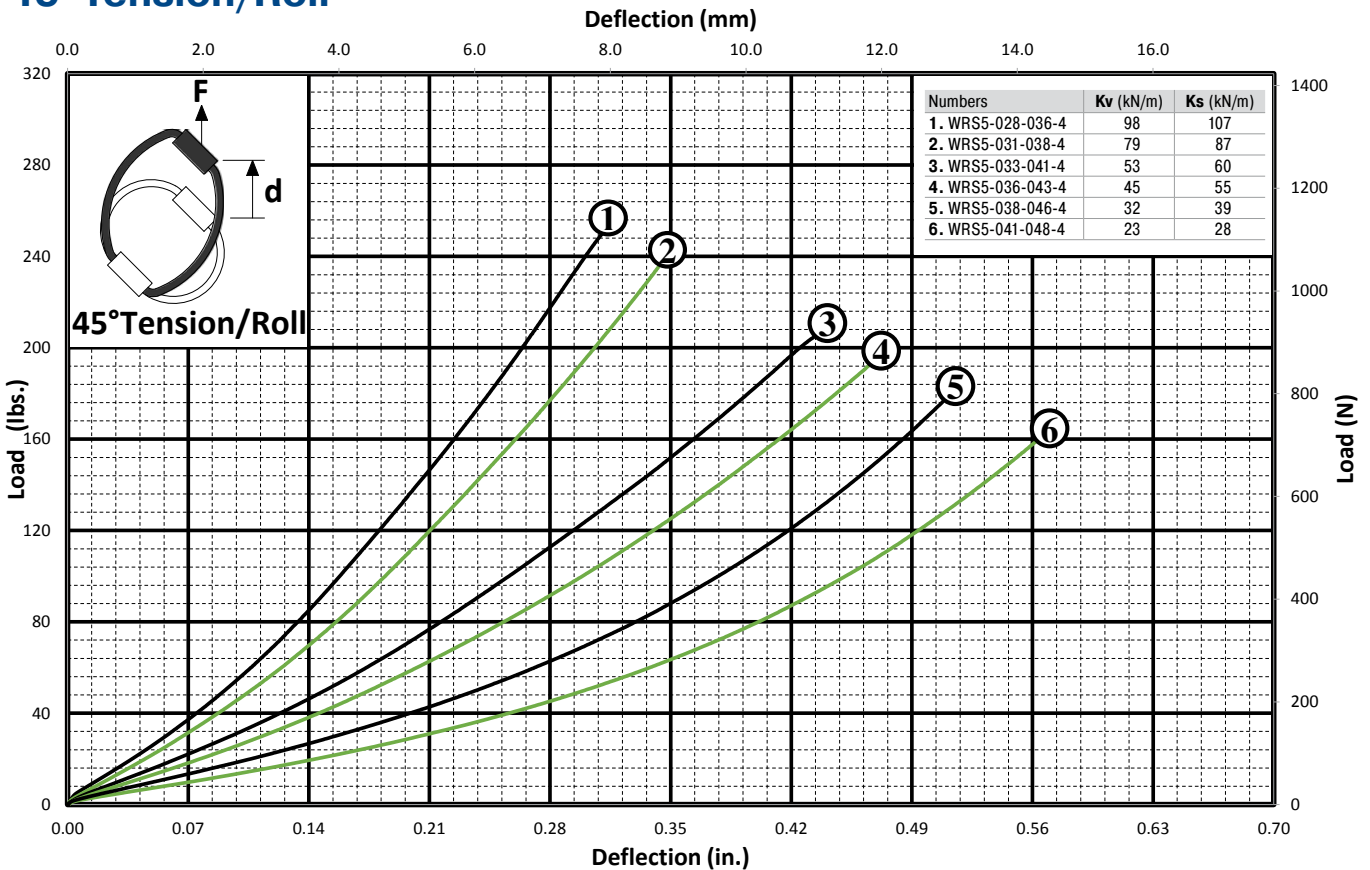

Issue 07.2020 – Specifications subject to change

# WRS6A

## Helical Isolator Short

### 4.76 mm (3/16") Diameter Cable

#### Features

- Rugged all metal construction
- Fail safe construction
- Long life and maintenance free
- Three axis capability (6 dof)
- High damping: C/cc ≈ 0.15 to 0.20

#### Operating temperature range

-130°C to +260°C

#### Material

- Cable: 300 Series SS per MIL-W-83420 or RR-W-410
- Screws: 300 Series SS per MS51959-28
- Inserts: 300 Series SS (alum bars only)
- Retainer bars: Standard: 6061-T6 Alum alloy/ Chem film IAW MIL-DTL-5541, TYPE II, Class 3

#### Note

- Mounting hole tolerances: ±0.25 mm
- Add 0.08 kg to Isolator weight for all stainless steel versions

#### On request

- Special materials, size, mounting holes, finish, etc. available

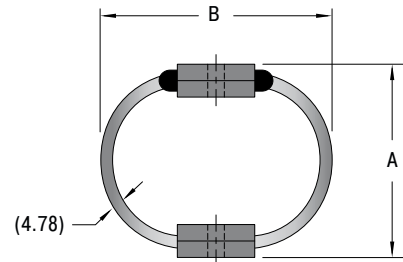
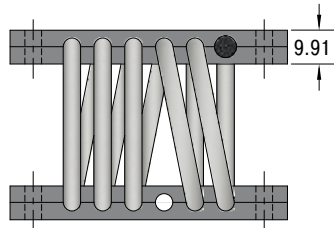
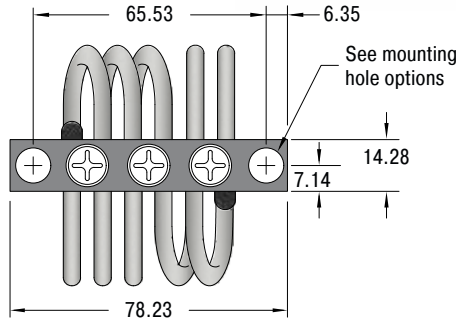

#### Performance

TYPEN	A (+/- 0.8) mm	B mm	Compression			Shear/Roll (Average)			Weight kg
			Kv (Vibe) kN/m	Ks (Shock) kN/m	Deflection max. mm	Kv (Vibe) kN/m	Ks (Shock) kN/m	Deflection max. mm	
WRS6A-051-058-5	50.8	57.9	37	26	25.4	12.1	13	25.4	0.089
WRS6A-052-064-5	52.3	63.5	30	22	26.7	8.2	11	26.7	0.092
WRS6A-054-075-5	54.1	74.7	21	15	27.9	6.1	8.1	27.9	0.097
WRS6A-056-081-5	55.6	81.0	14	11	29.2	5.1	6.7	29.2	0.105
WRS6A-062-088-5	62.2	87.6	13	8.8	40.6	2.3	5.1	40.6	0.109
WRS6A-081-107-5	81.3	106.7	7.0	3.9	55.9	1.4	2.6	55.9	0.132

#### Ordering Example

WRS6A-051-058-5-A

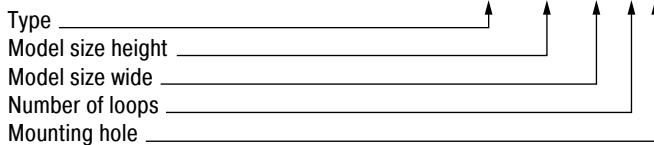

#### Mounting Hole Options

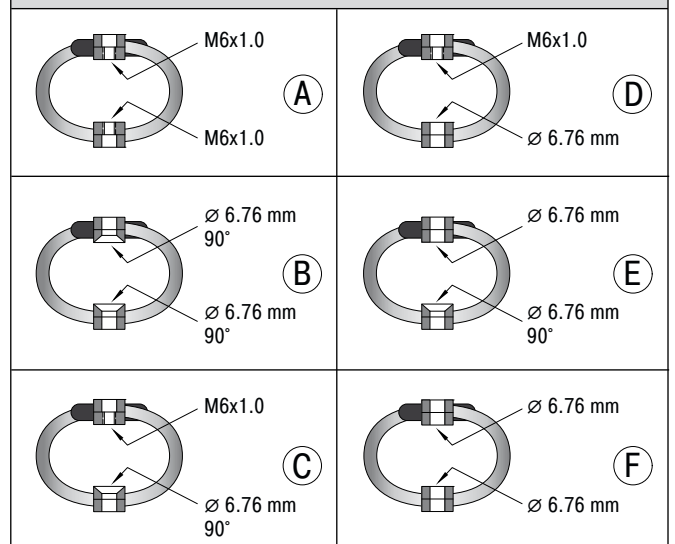

Issue 07.2020 – Specifications subject to change

### Compression

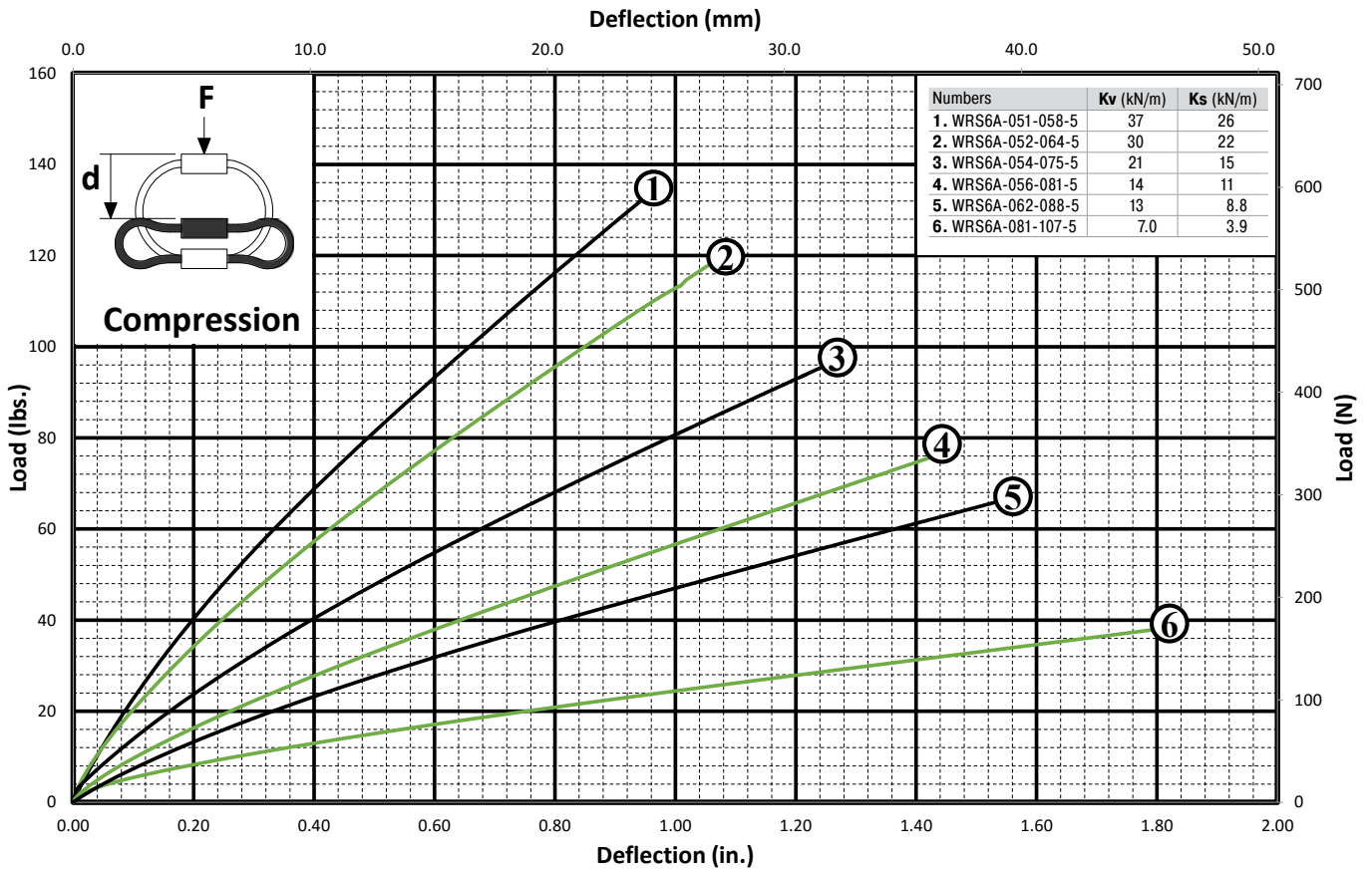

### Tension

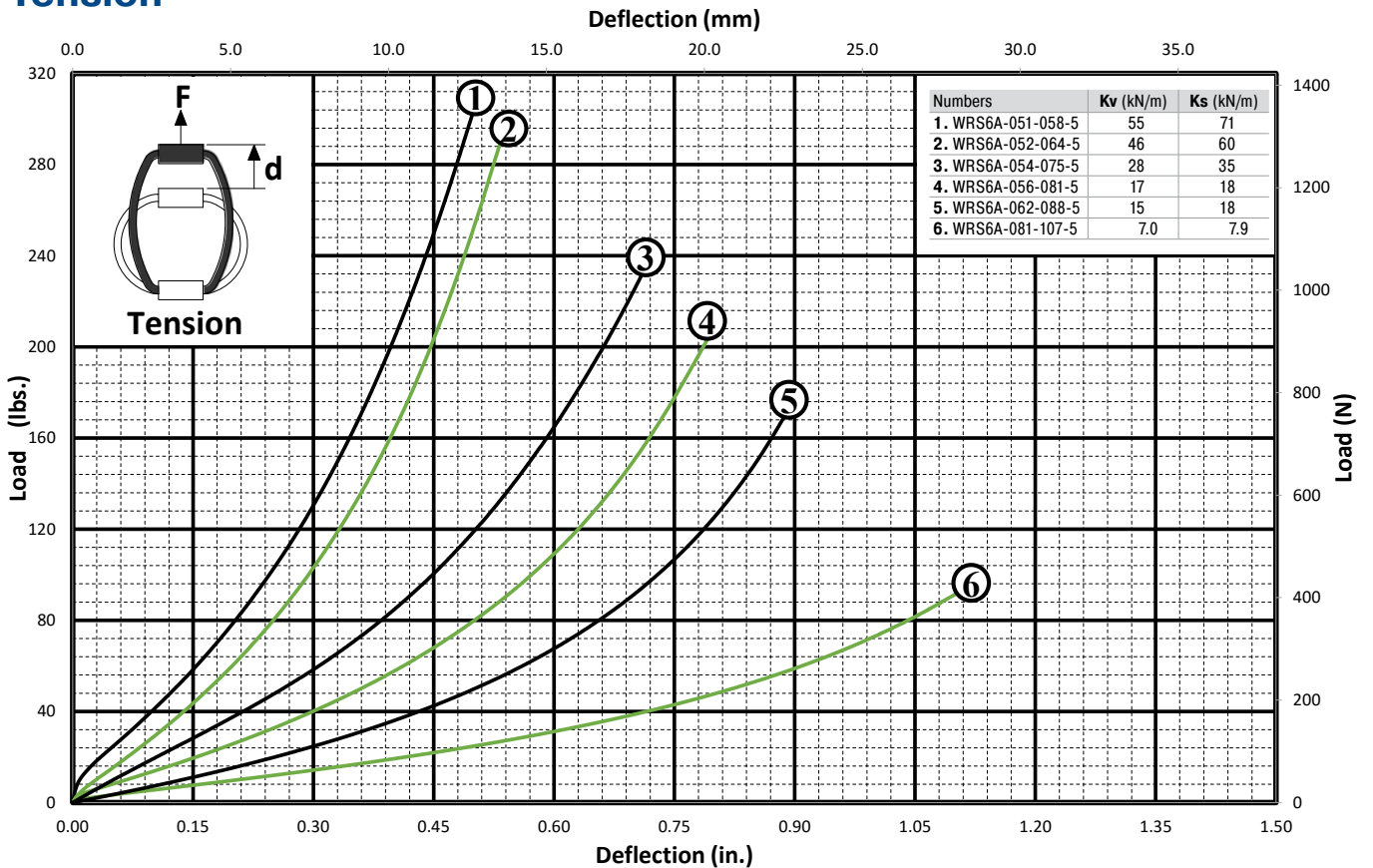

Issue 07.2020 – Specifications subject to change

Helical Isolator Short, 4.76 mm (3/16") Diameter Cable

### Shear

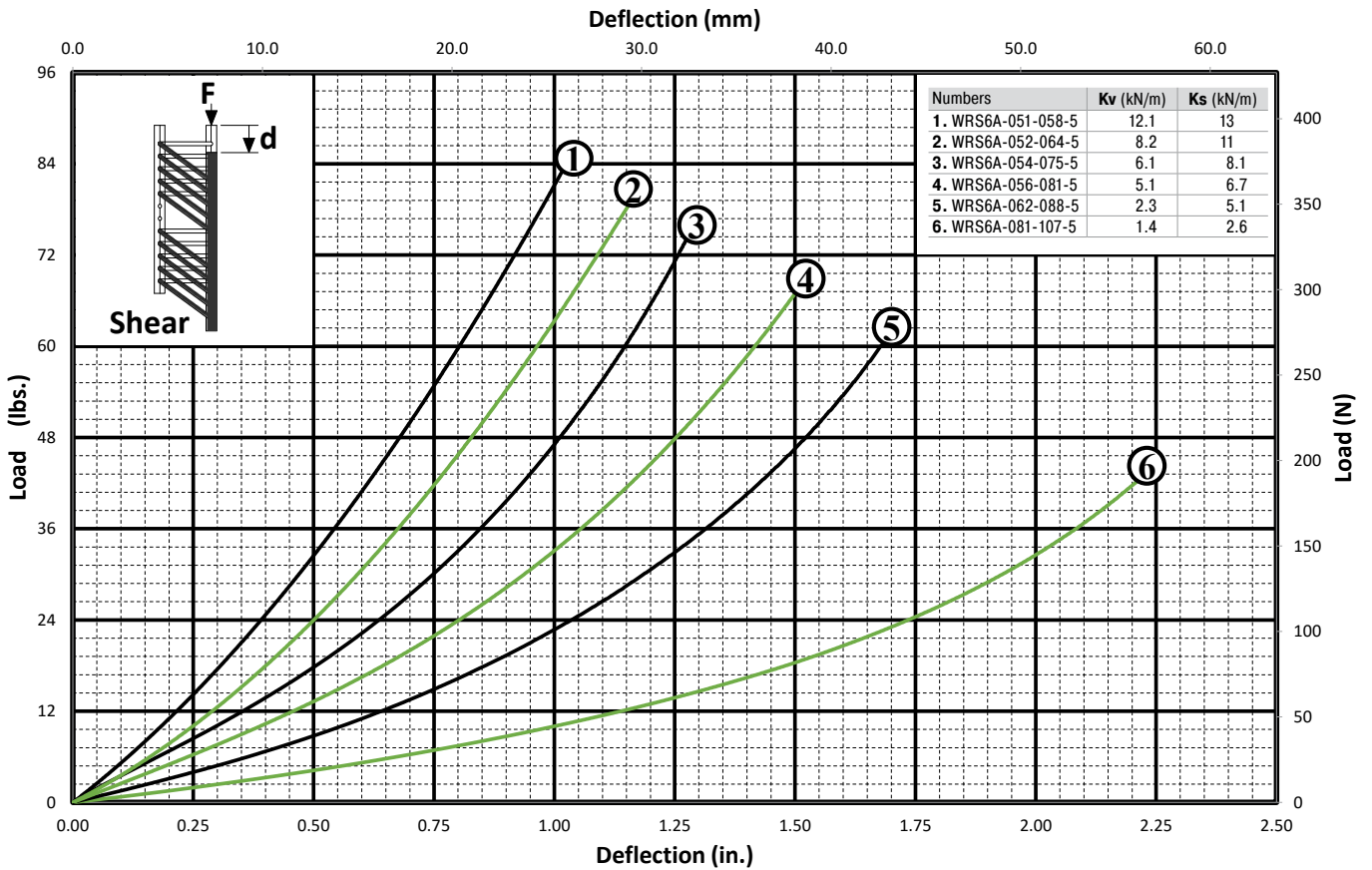

### Roll

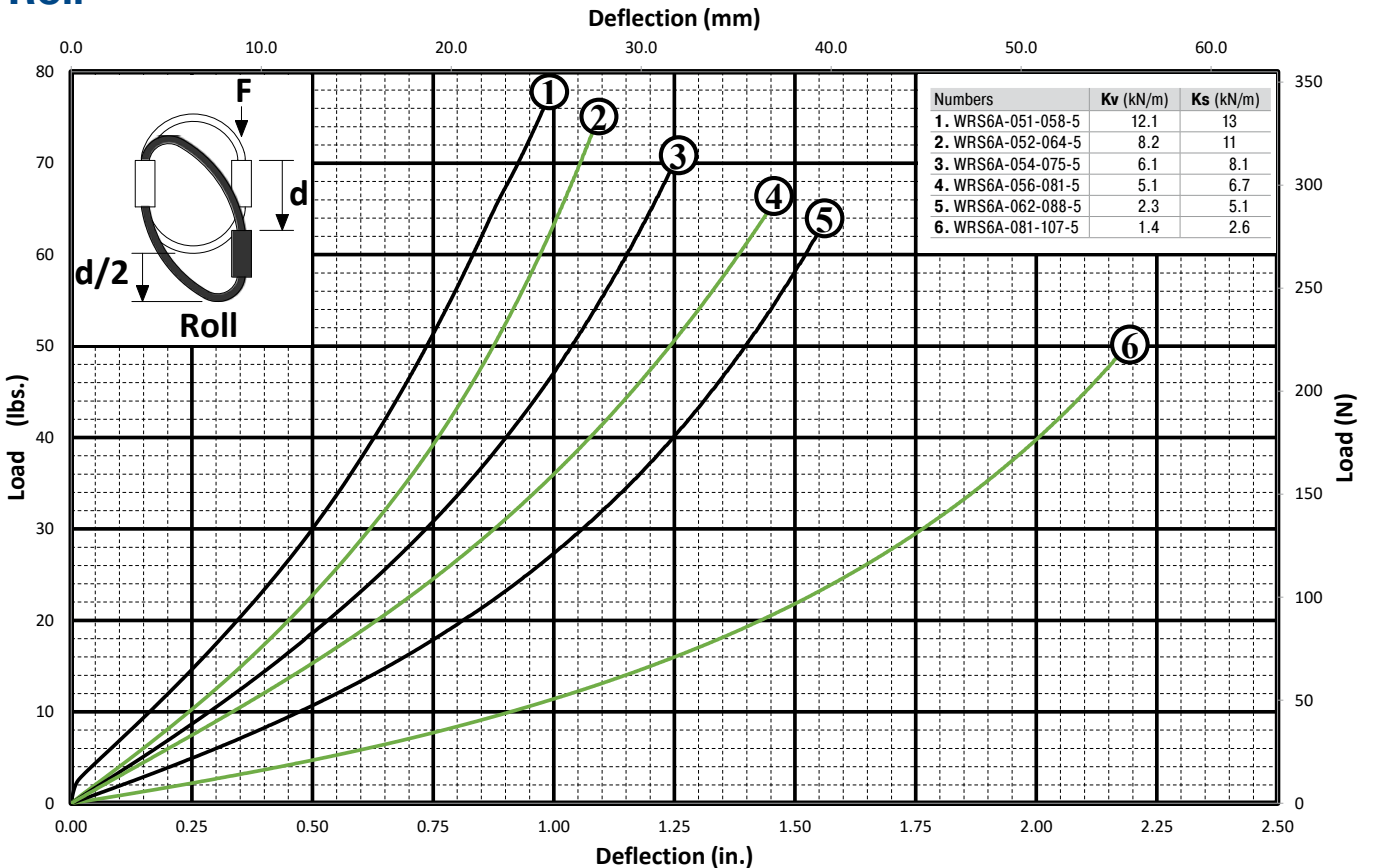

Issue 07.2020 – Specifications subject to change

### 45° Compression/Roll

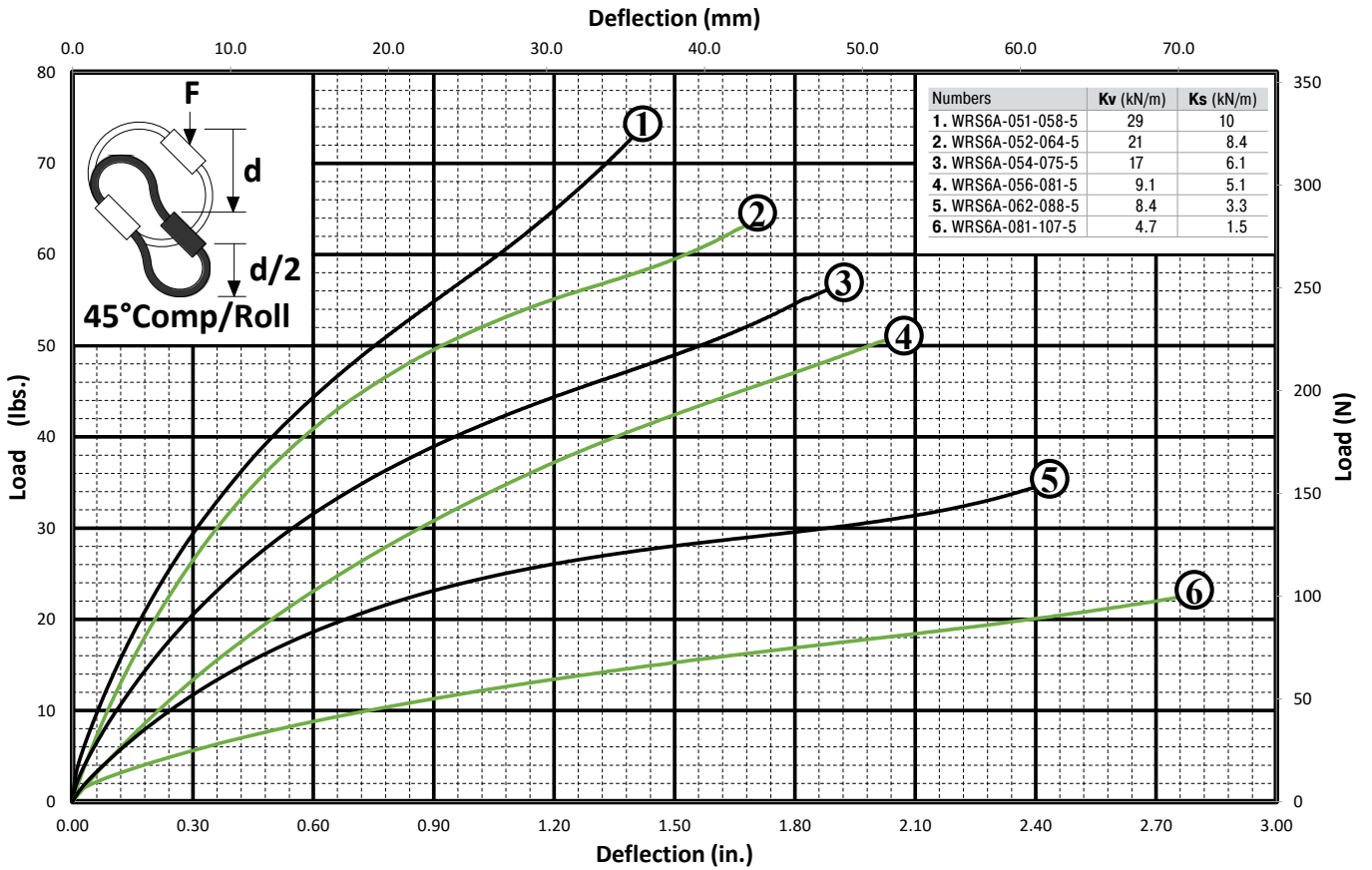

### 45° Tension/Roll

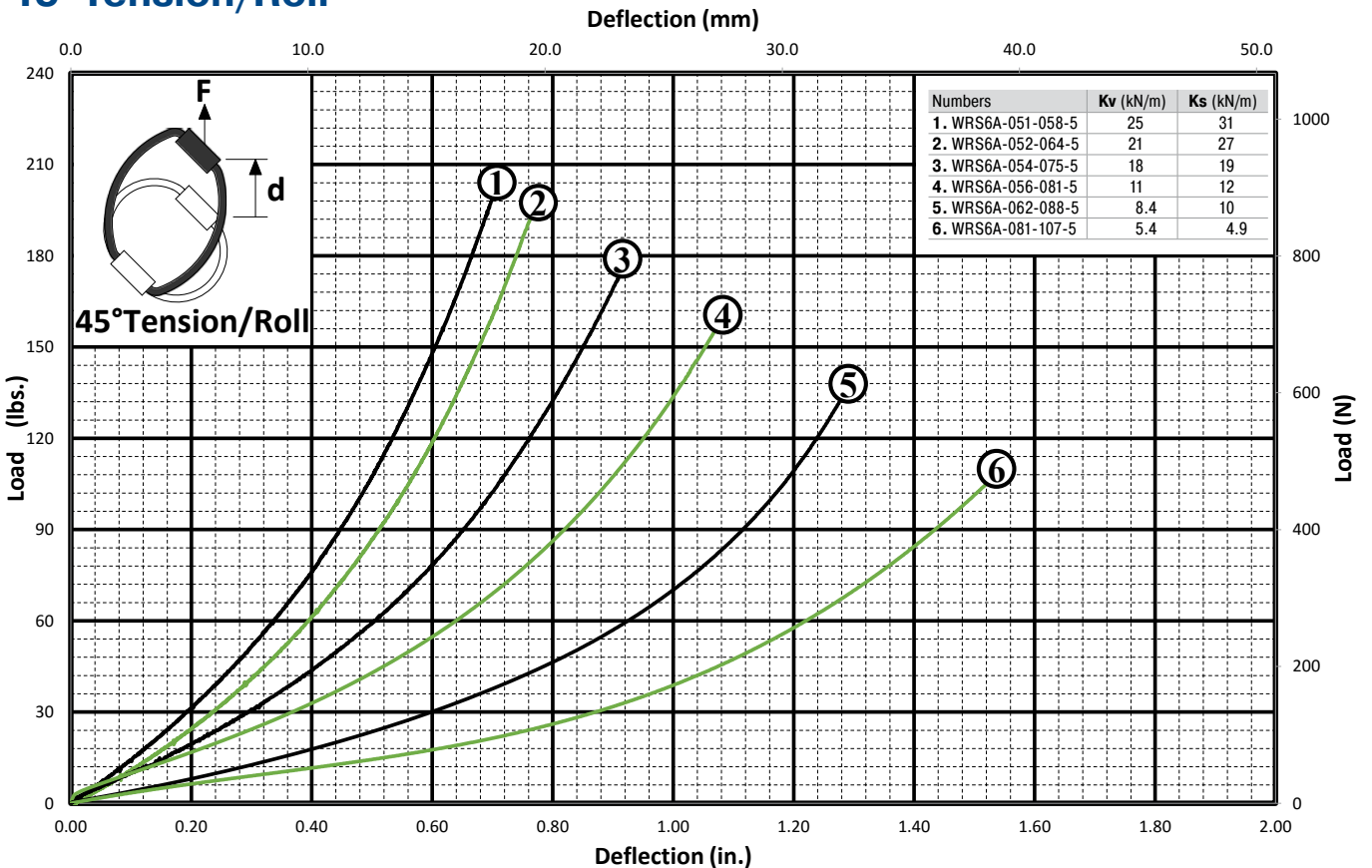



Product also available in stainless steel



# WRS6

## Helical Isolator Short

### 4.76 mm (3/16") Diameter Cable



**Features**

- Rugged all metal construction
- Fail safe construction
- Long life and maintenance free
- Three axis capability (6 dof)
- High damping: C/cc ≈ 0.15 to 0.20

**Operating temperature range**

-130°C to +260°C

**Material**

- Cable: 300 Series SS per MIL-W-83420 or RR-W-410
- Screws: 300 Series SS per MS51959-28
- Inserts: 300 Series SS (alum bars only)
- Retainer bars: Standard: 6061-T6 Alum alloy/ Chem film IAW MIL-DTL-5541, TYPE II, Class 3

**Note**

- Mounting hole tolerances: ±0.25 mm
- Add 0.06 kg to Isolator weight for all stainless steel versions

**On request**

Special materials, size, mounting holes, finish, etc. available

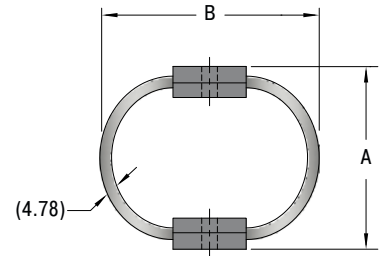
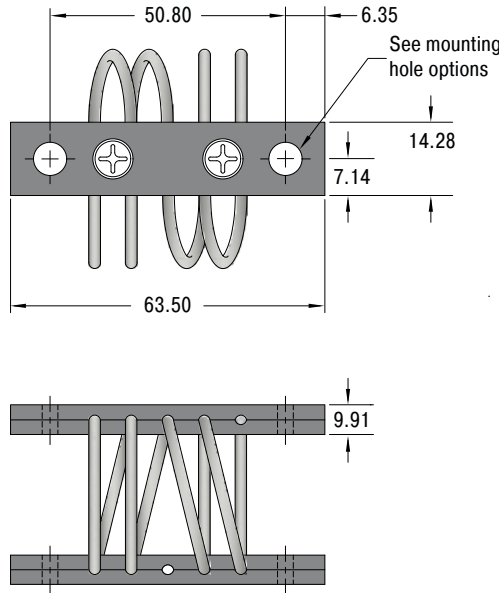

**Performance**

TYPEN	A (+/- 0.8) mm	B mm	Compression			Shear/Roll (Average)			Weight kg
			Kv (Vibe) kN/m	Ks (Shock) kN/m	Deflection max. mm	Kv (Vibe) kN/m	Ks (Shock) kN/m	Deflection max. mm	
WRS6-031-036-10	30.5	35.6	134	127	10.2	44	55	10.2	0.067
WRS6-033-038-10	33.0	38.1	111	99	11.4	40	49	11.4	0.068
WRS6-036-041-4	35.6	40.6	100	89	12.7	29	36	12.7	0.070
WRS6-038-043-4	38.1	43.2	88	75	15.2	25	33	15.2	0.073
WRS6-041-046-4	40.6	45.7	67	55	17.8	21	26	17.8	0.075
WRS6-043-048-4	43.2	48.2	52	41	20.3	15	22	20.3	0.077
WRS6-048-053-4	48.2	53.3	36	27	25.4	11	14	25.4	0.084
WRS6-051-058-4	51.0	58.4	30	23	27.9	8.6	12	27.9	0.089

**Ordering Example**

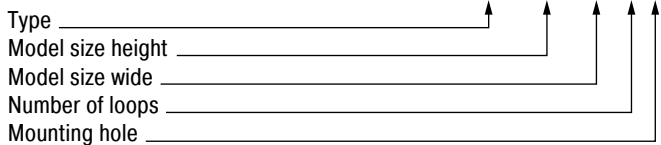

Mounting Hole Options	
<p>A</p>	<p>D</p>
<p>B</p>	<p>E</p>
<p>C</p>	<p>F</p>

Issue 07.2020 – Specifications subject to change

### Compression

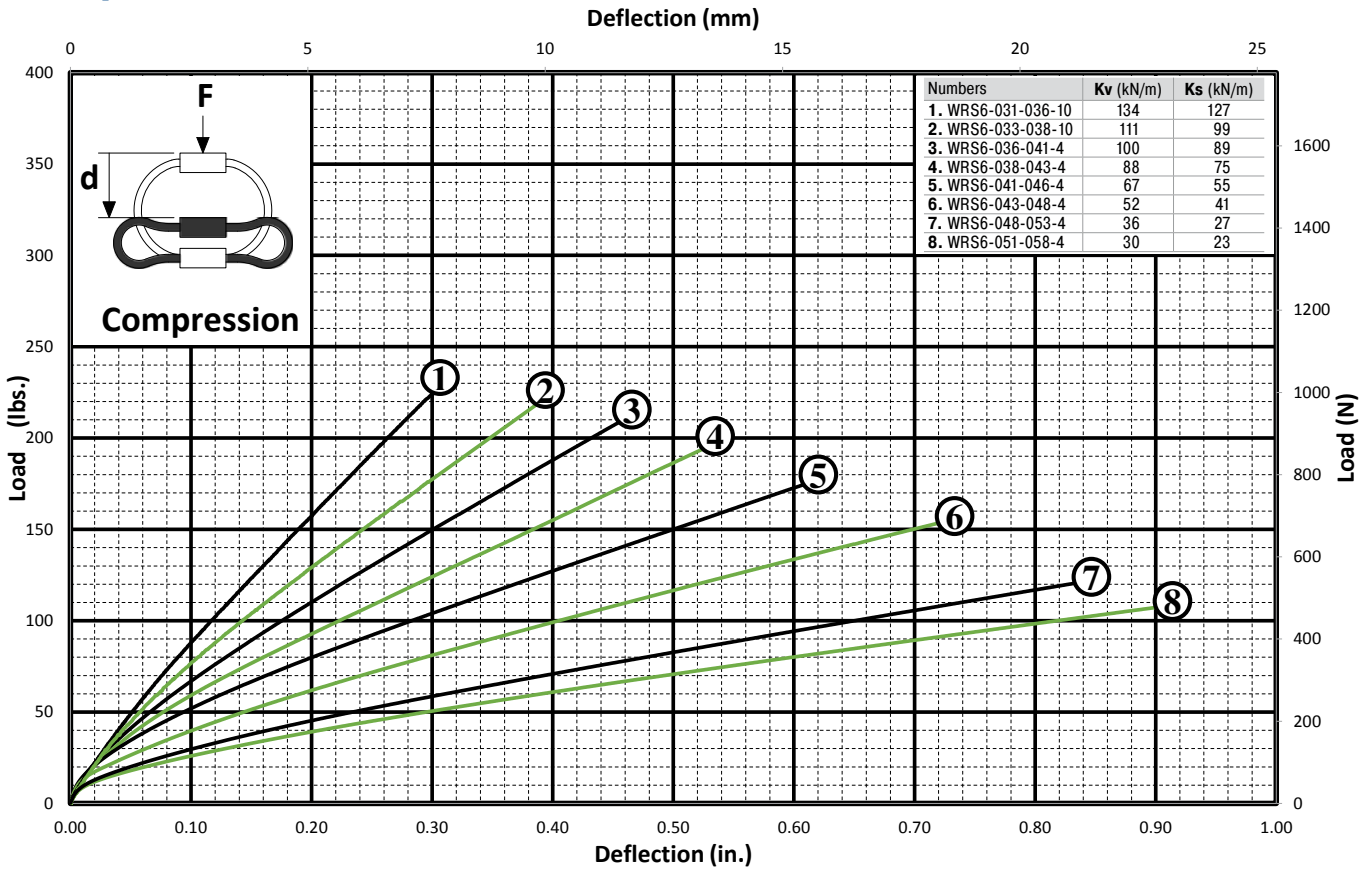

### Tension

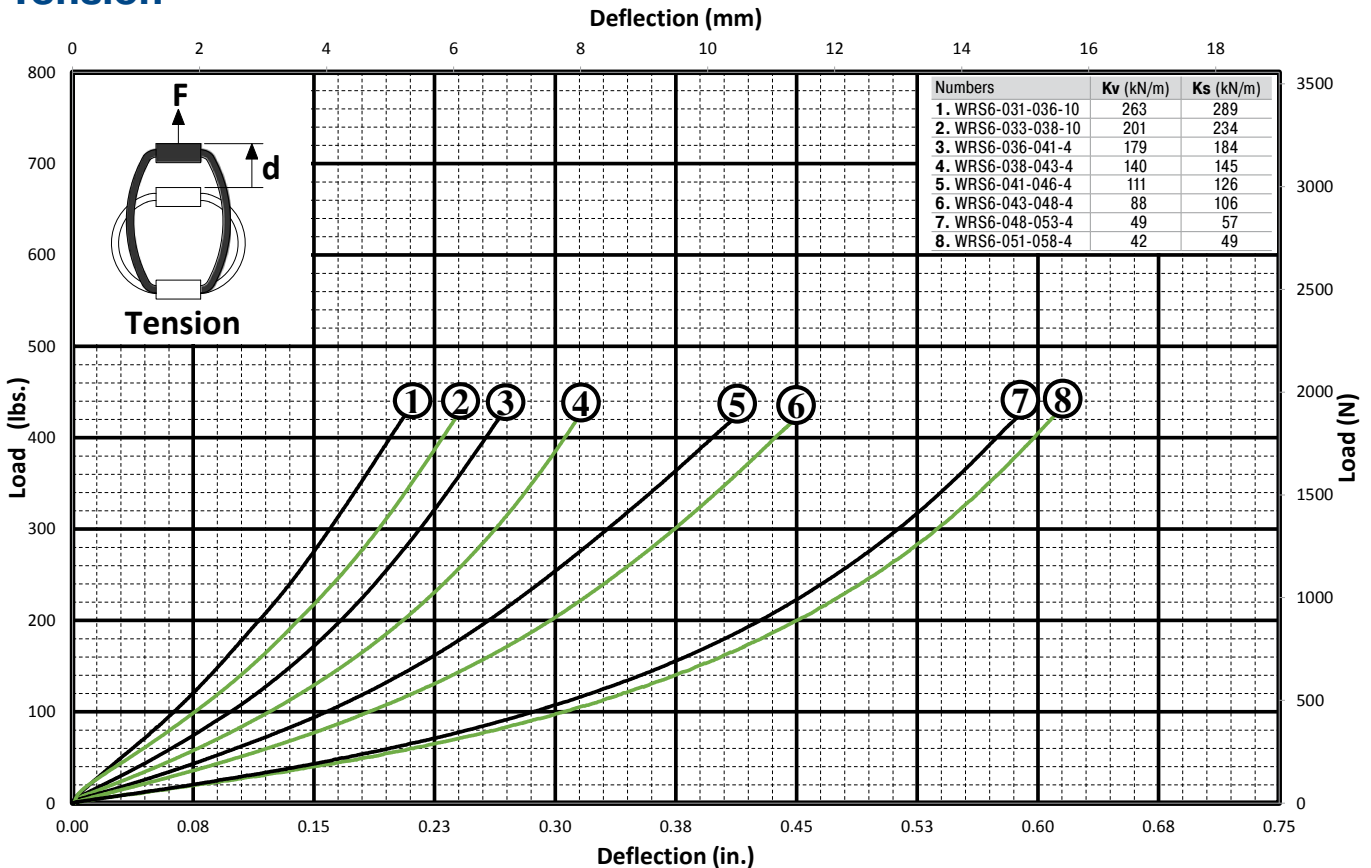

Issue 07.2020 – Specifications subject to change

Helical Isolator Short, 4.76 mm (3/16") Diameter Cable

### Shear

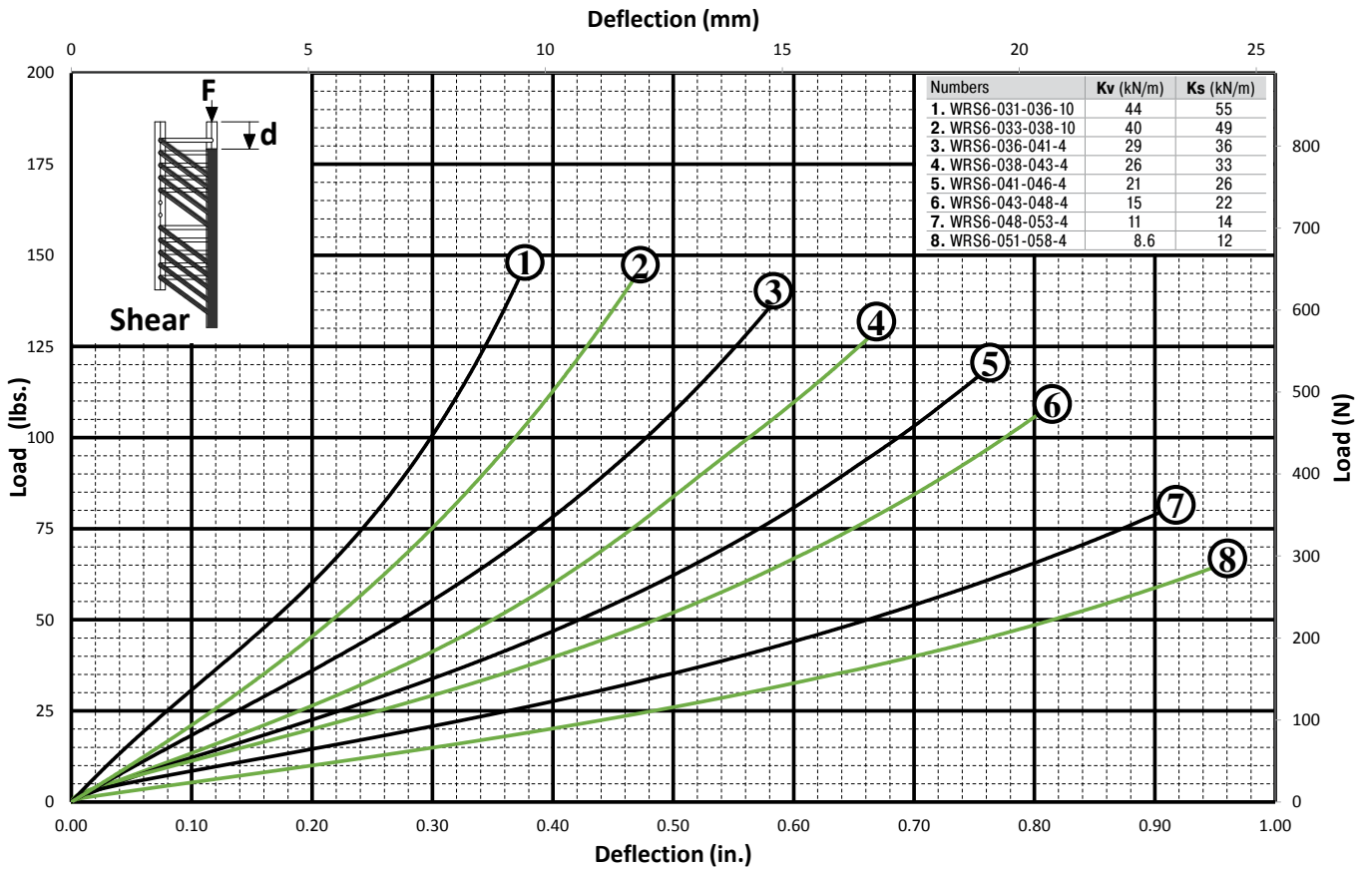

### Roll

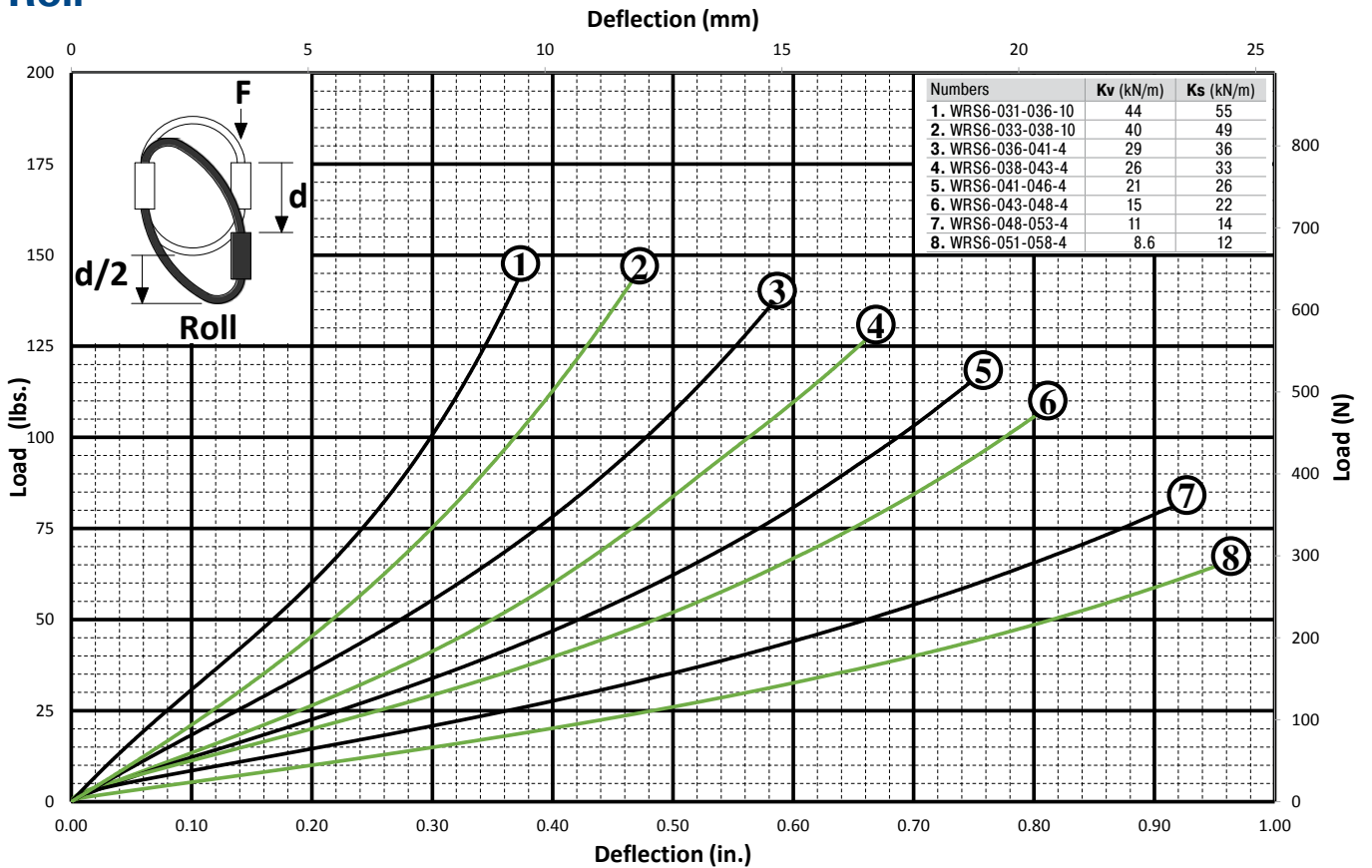

Issue 07.2020 – Specifications subject to change

### 45° Compression/Roll

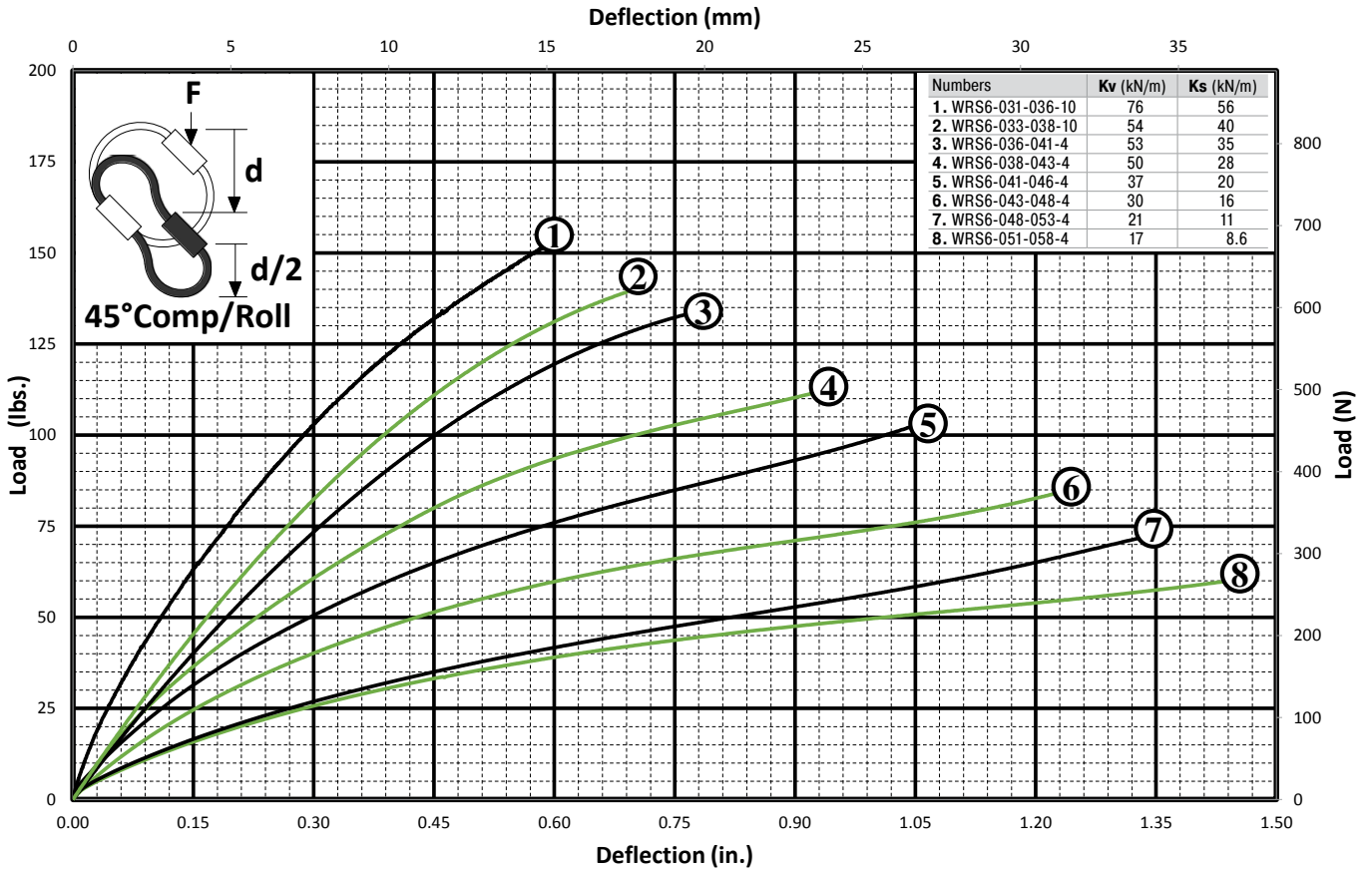

### 45° Tension/Roll

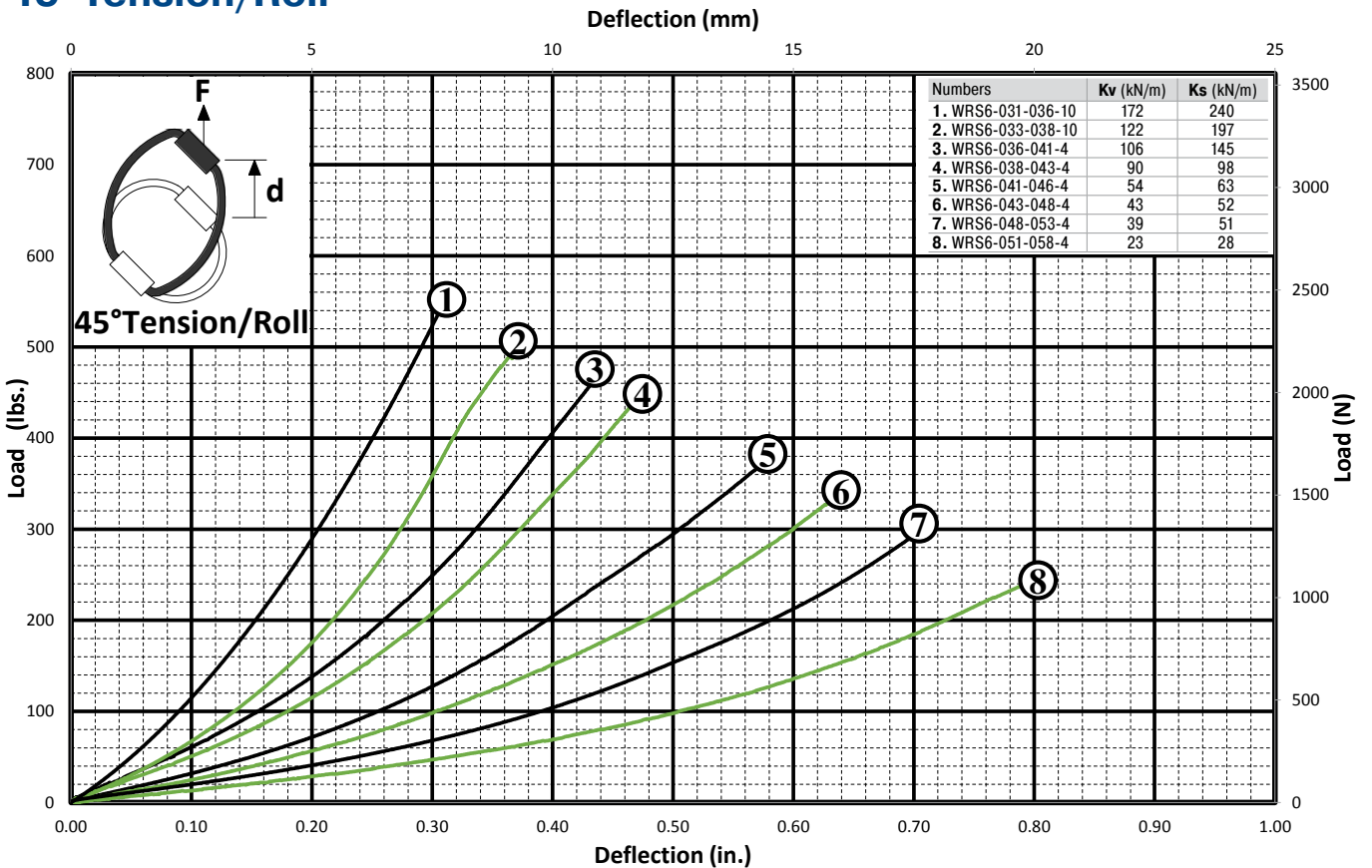

Issue 07.2020 – Specifications subject to change

Product also available in stainless steel



# WRS8

## Helical Isolator Short

### 6.35 mm (1/4") Diameter Cable

#### Features

- Rugged all metal construction
- Fail safe construction
- Long life and maintenance free
- Three axis capability (6 dof)
- High damping: C/cc ≈ 0.15 to 0.20

#### Operating temperature range

-130°C to +260°C

#### Material

- Cable: 300 Series SS per MIL-W-83420 or RR-W-410
- Screws: 300 Series SS passivated IAW ASTM A967
- Inserts: 300 Series SS (alum bars only)
- Retainer bars: Standard: 6061-T6 Alum alloy/ Chem film IAW MIL-DTL-5541, TYPE II, Class 3

#### Note

- Mounting hole tolerances: ±0.25 mm
- Add 0.10 kg to Isolator weight for all stainless steel versions

#### On request

- Special materials, size, mounting holes, finish, etc. available

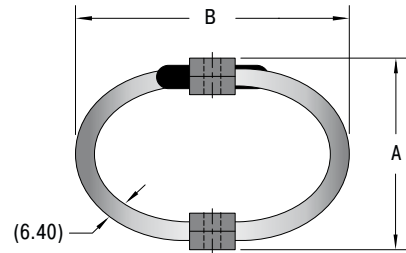
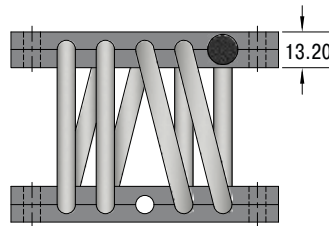
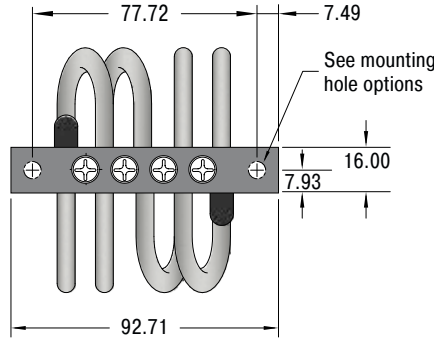

#### Performance

TYPEN	A (+/- 0.8) mm	B mm	Compression			Shear/Roll (Average)			Weight kg
			Kv (Vibe) kN/m	Ks (Shock) kN/m	Deflection max. mm	Kv (Vibe) kN/m	Ks (Shock) kN/m	Deflection max. mm	
WRS8-048-056-4	48.4	55.9	111	84	17.8	34	38	17.8	0.159
WRS8-054-064-4	54.1	63.5	82	60	22.9	34	28	22.9	0.173
WRS8-059-071-4	58.7	71.1	58	39	27.9	21	19	27.9	0.179
WRS8-062-080-4	62.2	79.5	39	27	31.8	15	14	31.8	0.194
WRS8-065-089-4	64.8	88.9	25	18	34.3	11	9.6	34.3	0.213
WRS8-066-095-4	66.0	95.3	25	18	35.6	8.9	8.8	35.6	0.221
WRS8-069-100-4	68.6	100.3	19	12	38.1	7.4	6.8	38.1	0.227
WRS8-083-108-4	82.6	108.0	14	8.6	52.1	5.1	4.7	52.1	0.247

#### Ordering Example

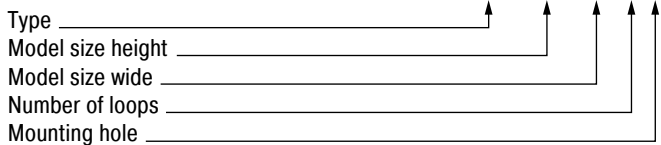

#### Mounting Hole Options

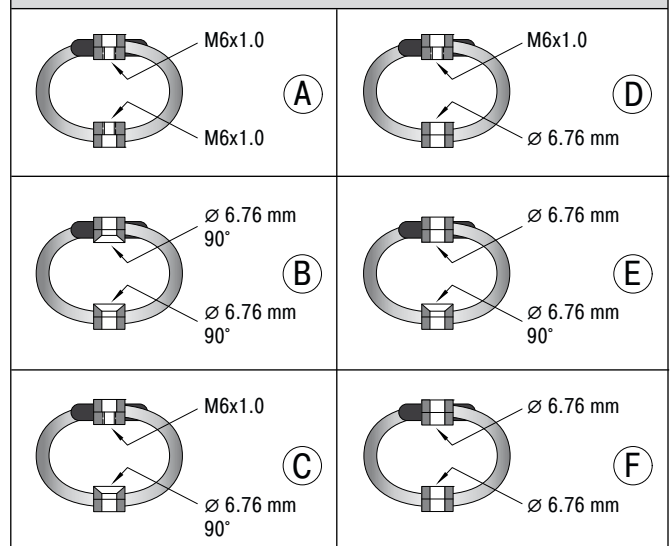

Issue 07.2020 – Specifications subject to change



### Compression

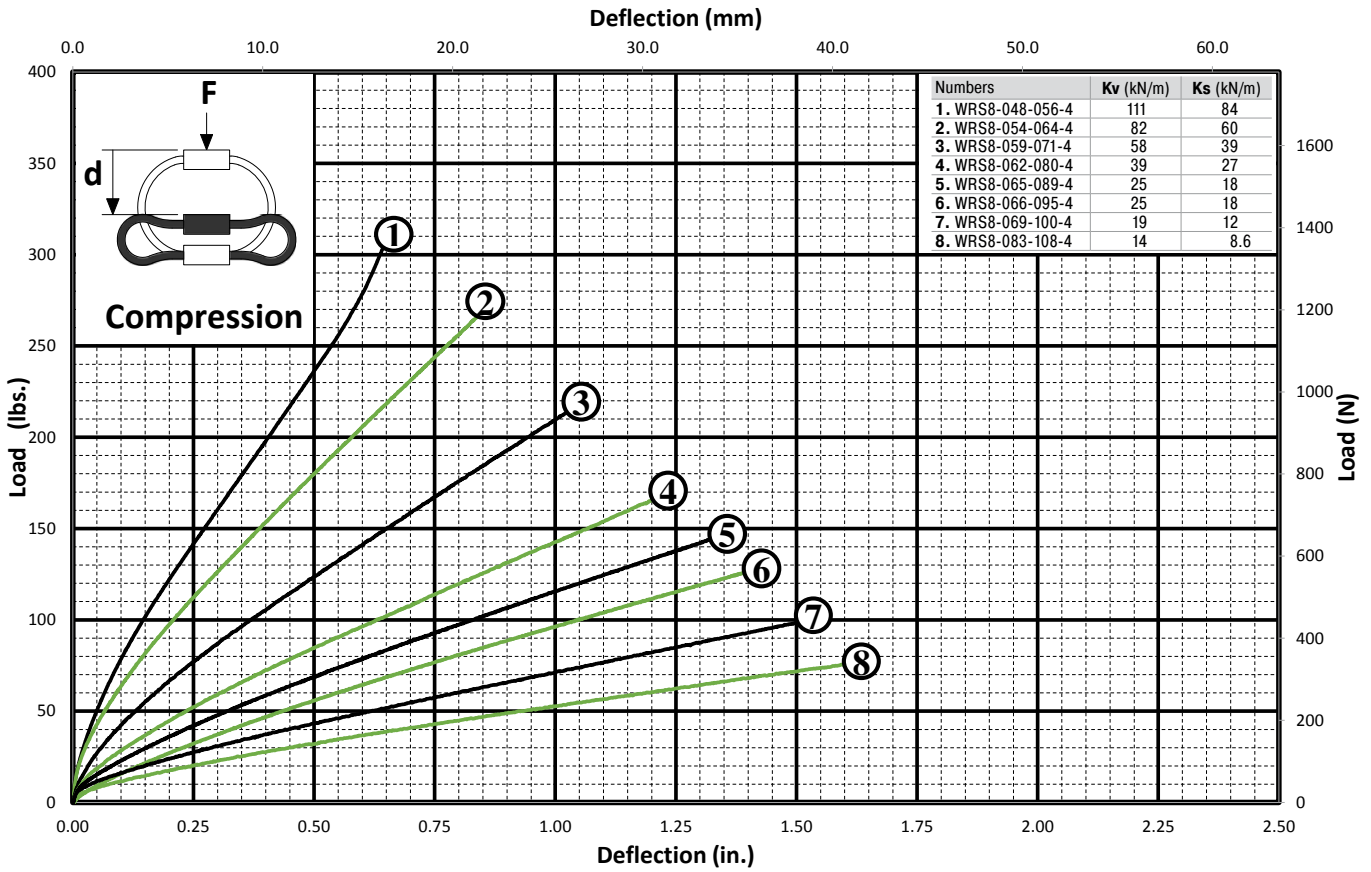

### Tension

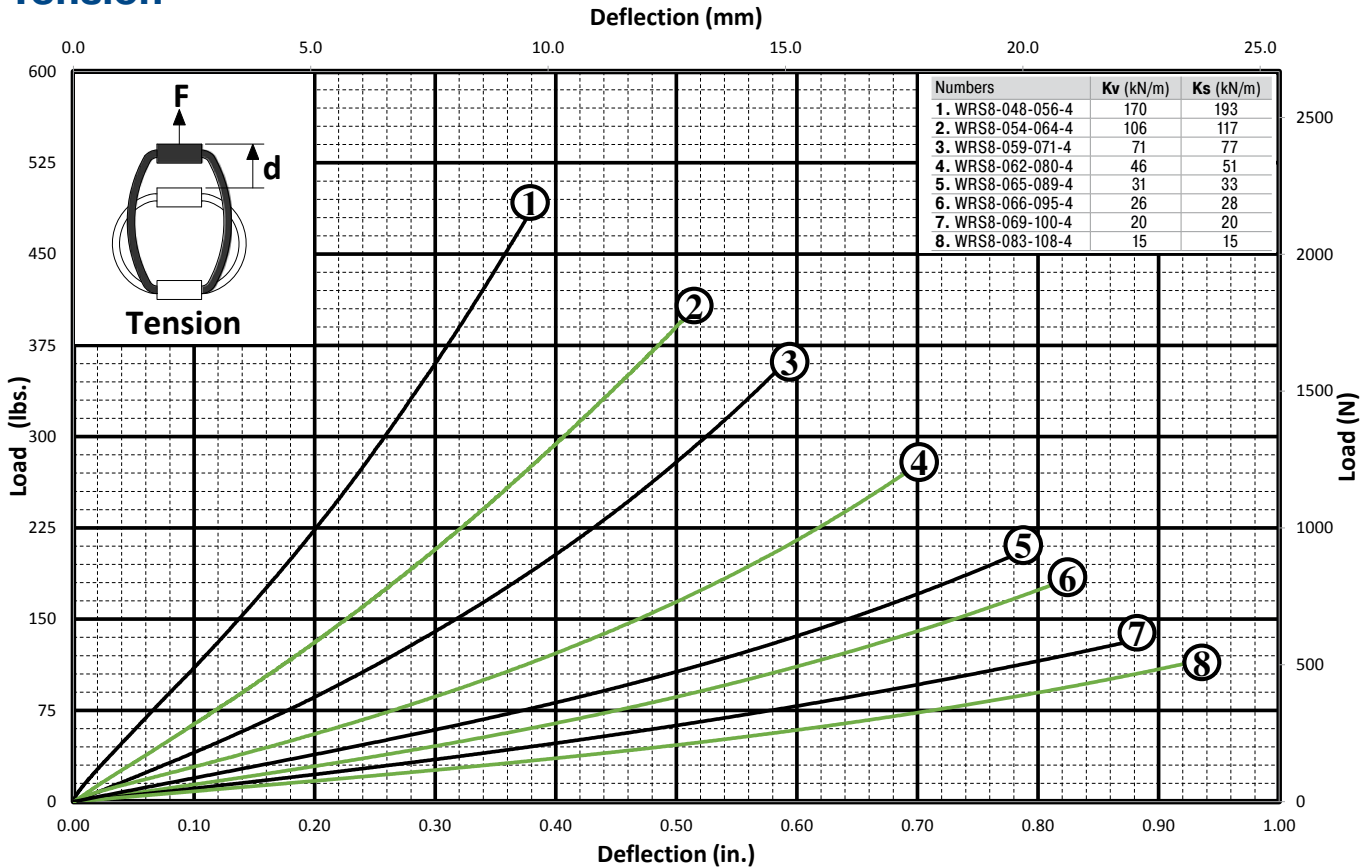

Issue 07.2020 – Specifications subject to change

### Shear

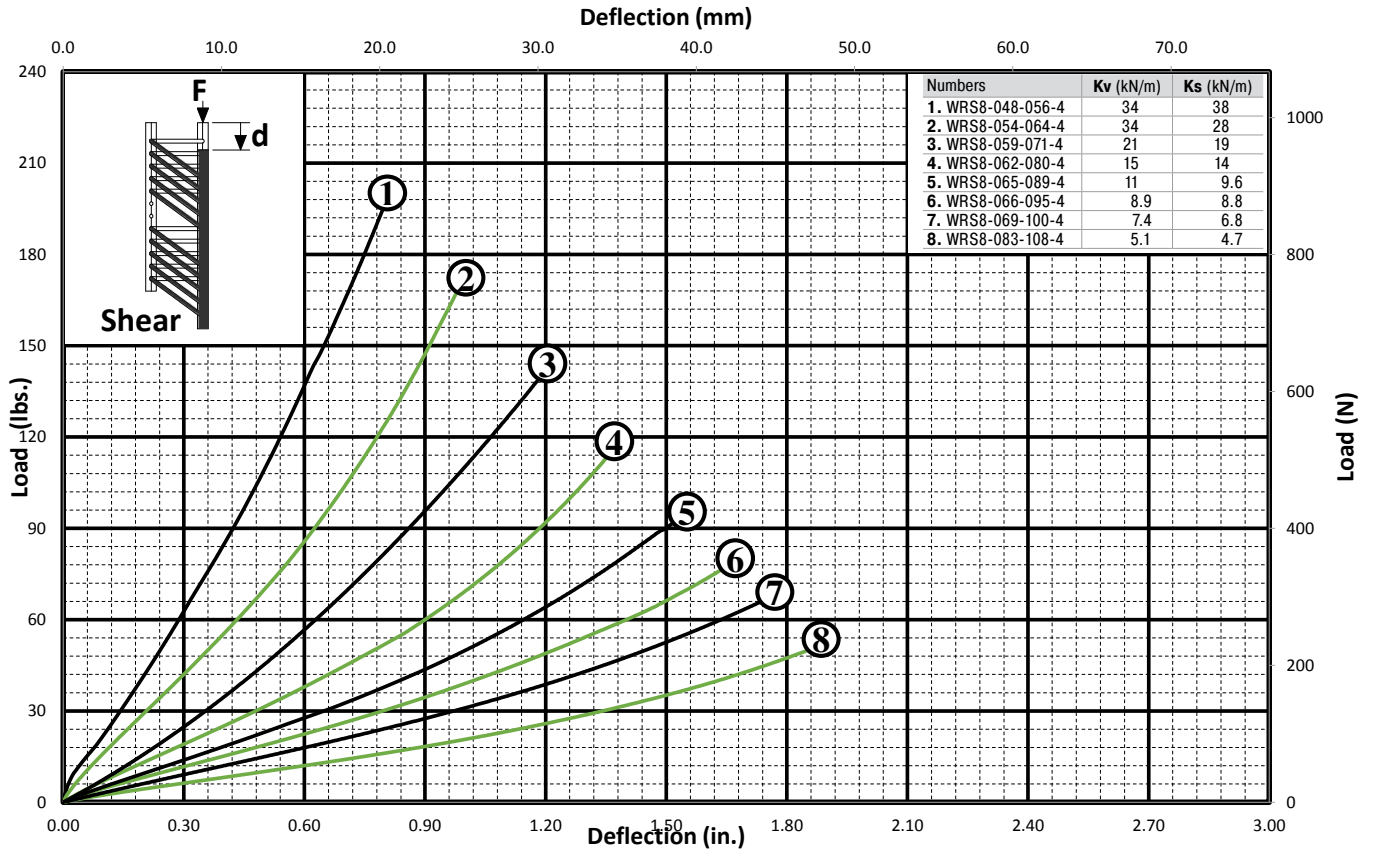

### Roll

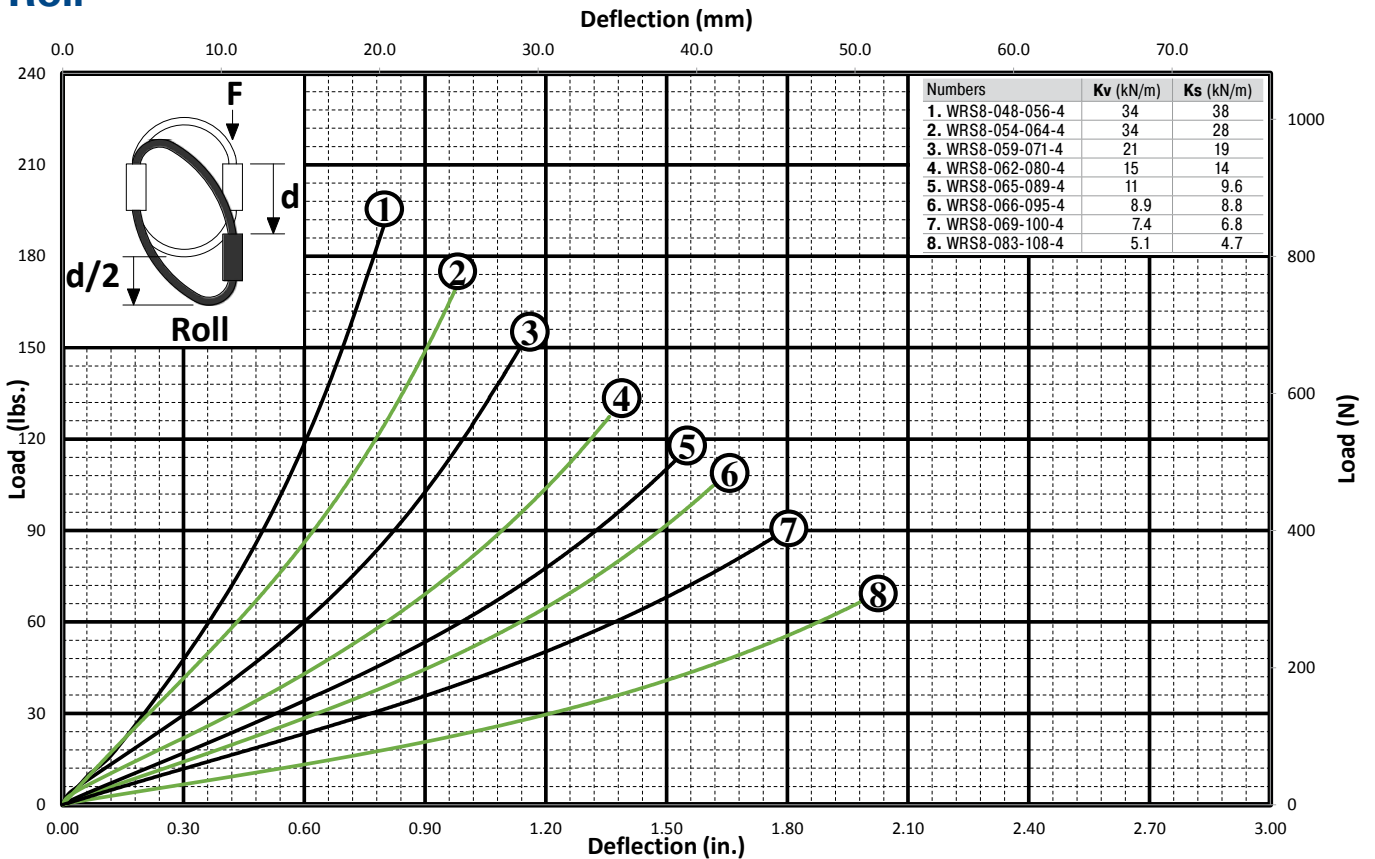

### 45° Compression/Roll

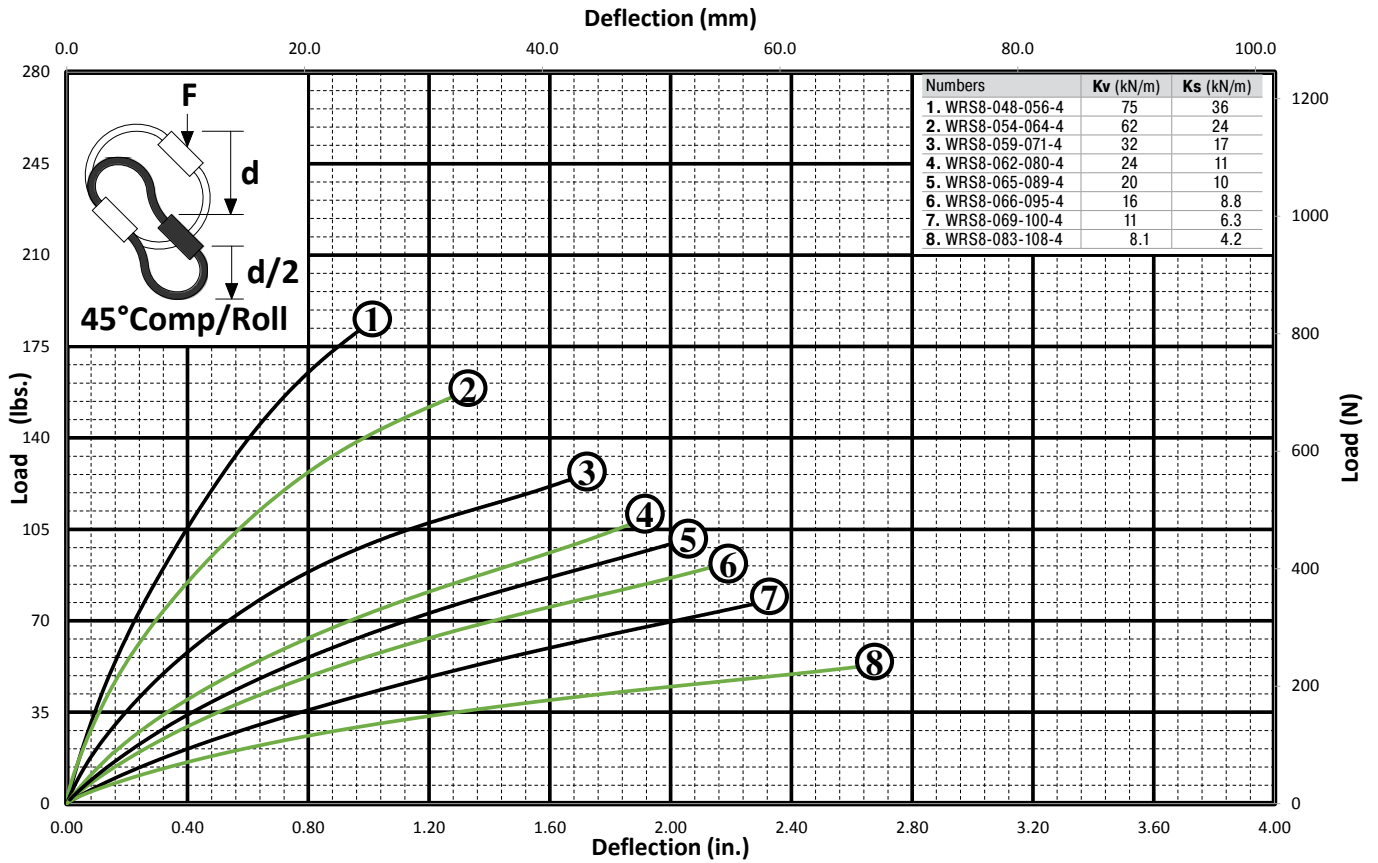

### 45° Tension/Roll

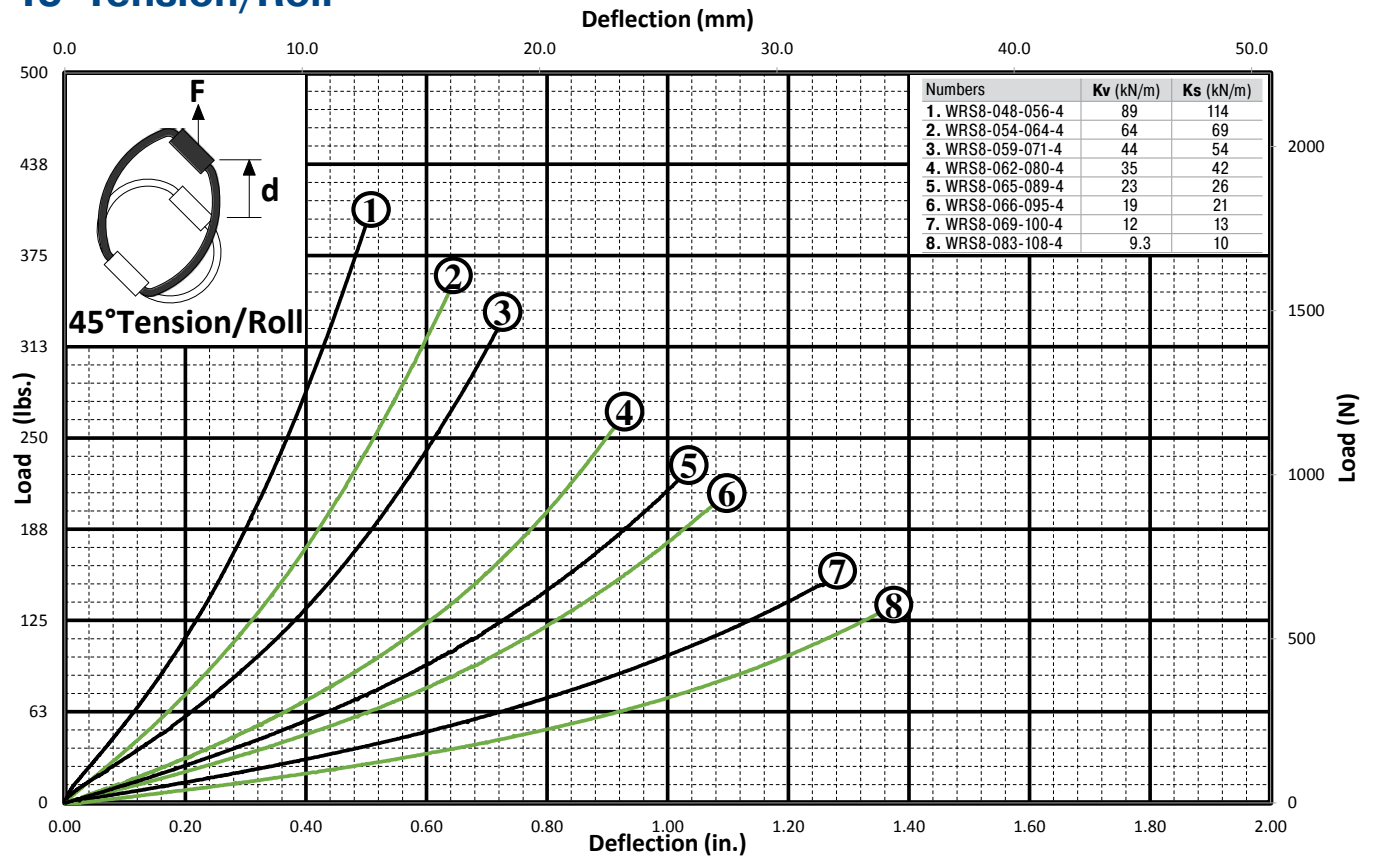

# WRS12

## Helical Isolator Short

### 9.53 mm (3/8") Diameter Cable

#### Features

- Rugged all metal construction
- Fail safe construction
- Long life and maintenance free
- Three axis capability (6 dof)
- High damping: C/cc ≈ 0.15 to 0.20

#### Operating temperature range

-130°C to +260°C

#### Material

- Cable: 300 Series SS per MIL-W-83420 or RR-W-410
- Screws: 300 Series SS passivated IAW ASTM A967
- Inserts: 300 Series SS (alum bars only)
- Retainer bars: Standard: 6061-T6 Alum alloy/ Chem film IAW MIL-DTL-5541, TYPE II, Class 3

#### Note

- Mounting hole tolerances: ±0.25 mm
- Add 0.39 kg to Isolator weight for all stainless steel versions

#### On request

- Special materials, size, mounting holes, finish, etc. available

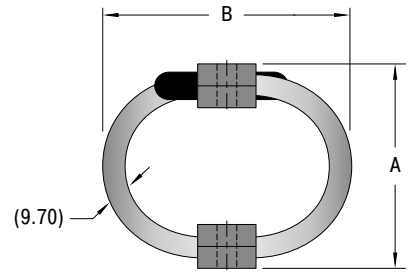
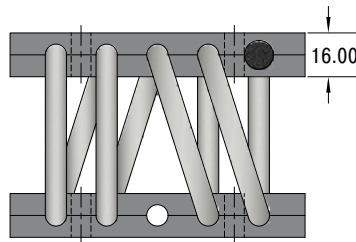
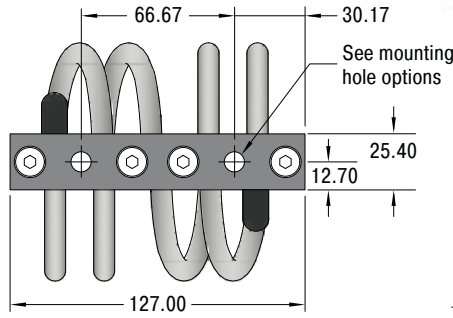

#### Performance

TYPEN	A (+/- 0.8) mm	B mm	Compression			Shear/Roll (Average)			Weight kg
			Kv (Vibe) kN/m	Ks (Shock) kN/m	Deflection max. mm	Kv (Vibe) kN/m	Ks (Shock) kN/m	Deflection max. mm	
WRS12-071-084-4	71.1	84.1	151	96	31.8	44	64	31.8	0.53
WRS12-074-089-4	73.7	88.9	132	82	34.3	39	46	34.3	0.54
WRS12-076-105-4	76.2	104.9	116	68	36.8	37	40	36.8	0.58
WRS12-083-108-4	82.6	108.0	94	55	43.2	37	35	43.2	0.60
WRS12-089-108-4	88.9	108.0	89	49	49.5	29	31	49.5	0.62
WRS12-105-121-4	104.9	120.7	57	32	66.0	13	22	66.0	0.68
WRS12-108-140-4	108.0	139.7	42	22	68.6	12	14	68.6	0.74

#### Ordering Example

WRS12-071-084-4-A

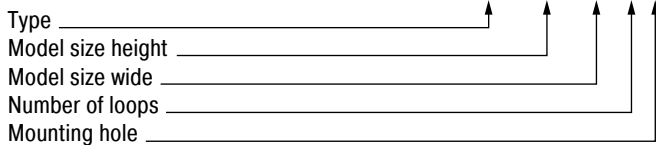

#### Mounting Hole Options

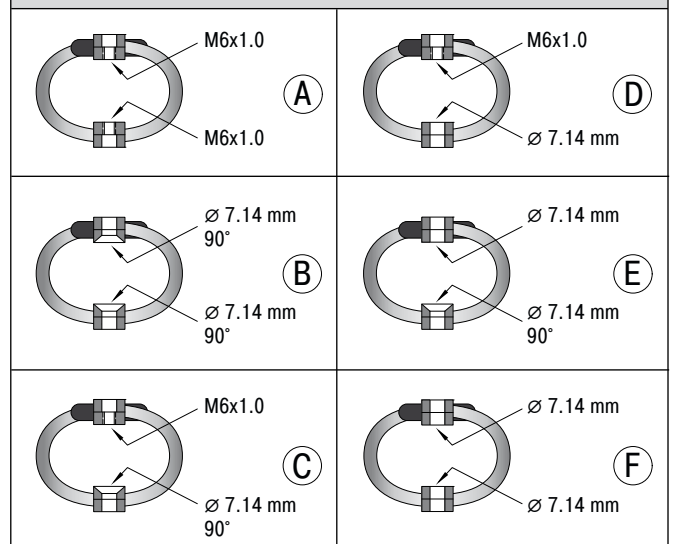

Issue 07.2020 – Specifications subject to change

## Compression

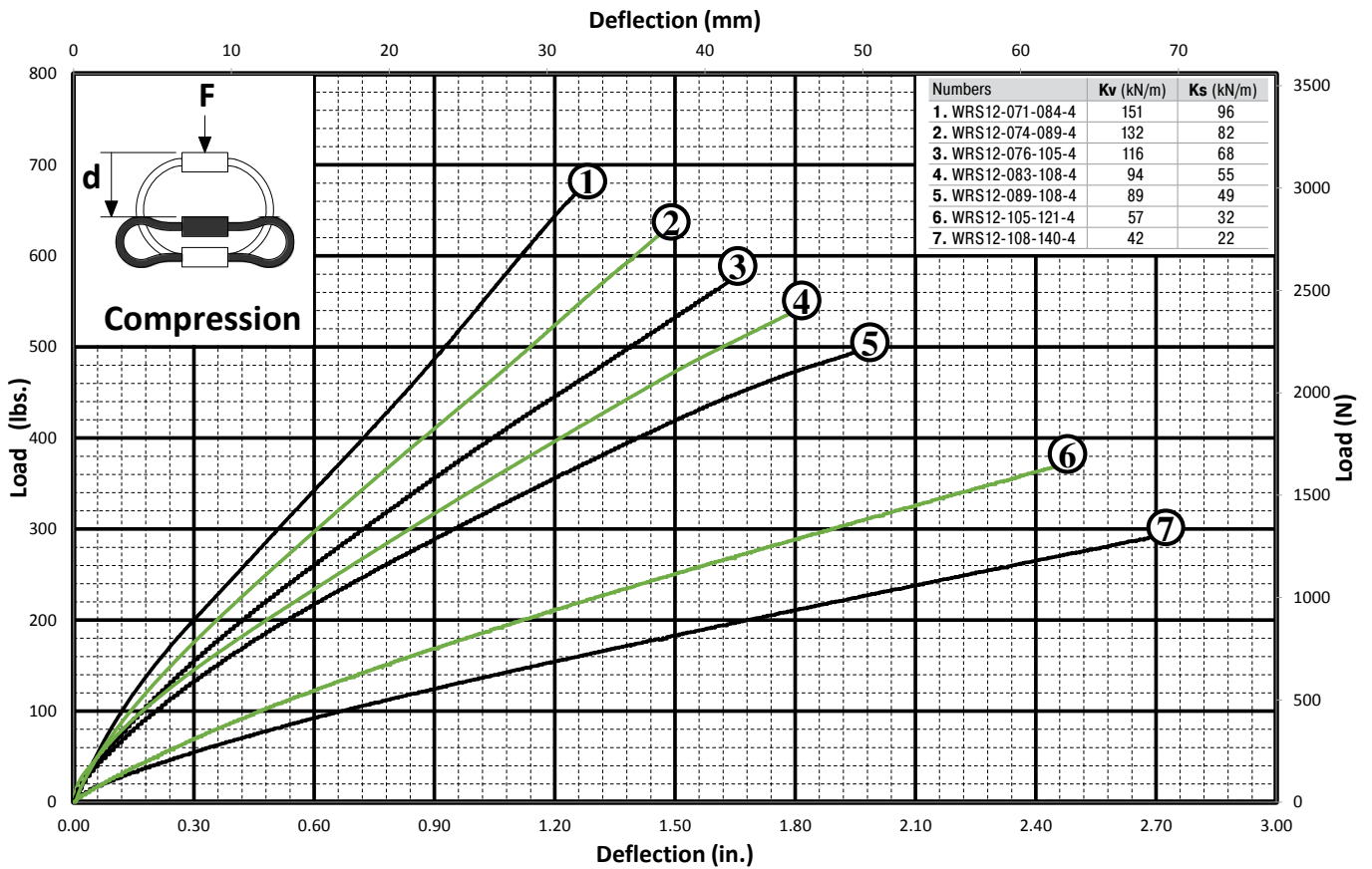

## Tension

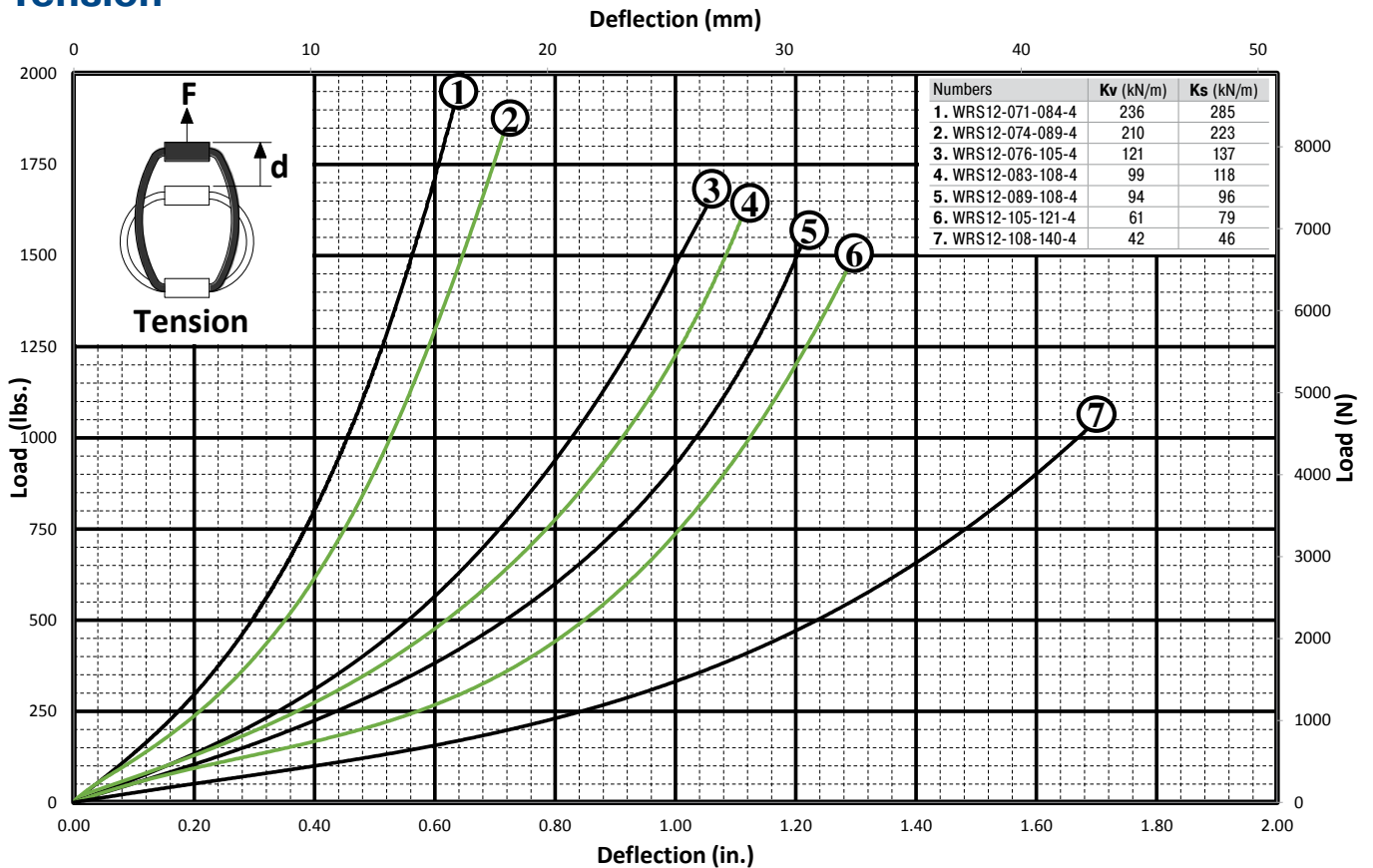



### Shear

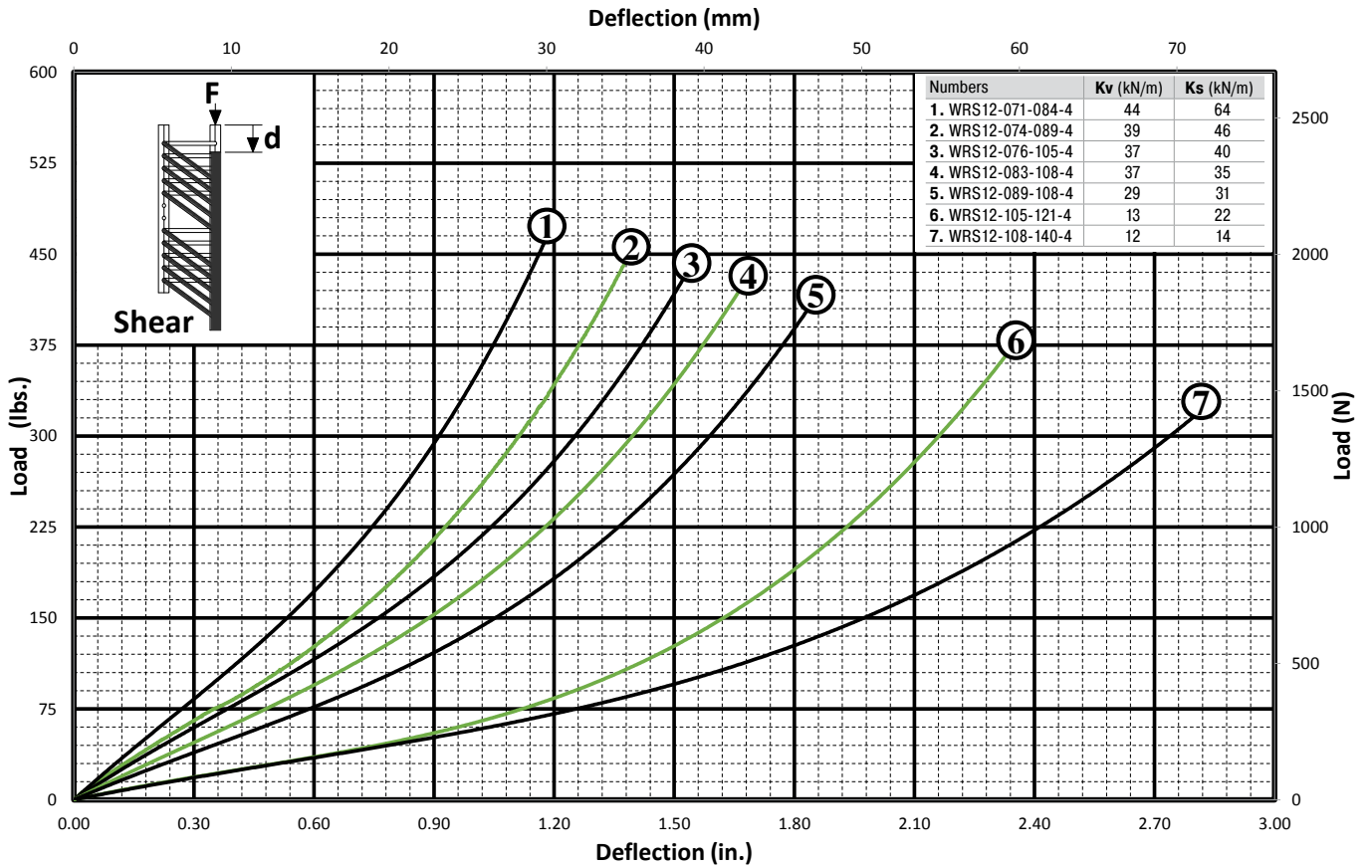

### Roll

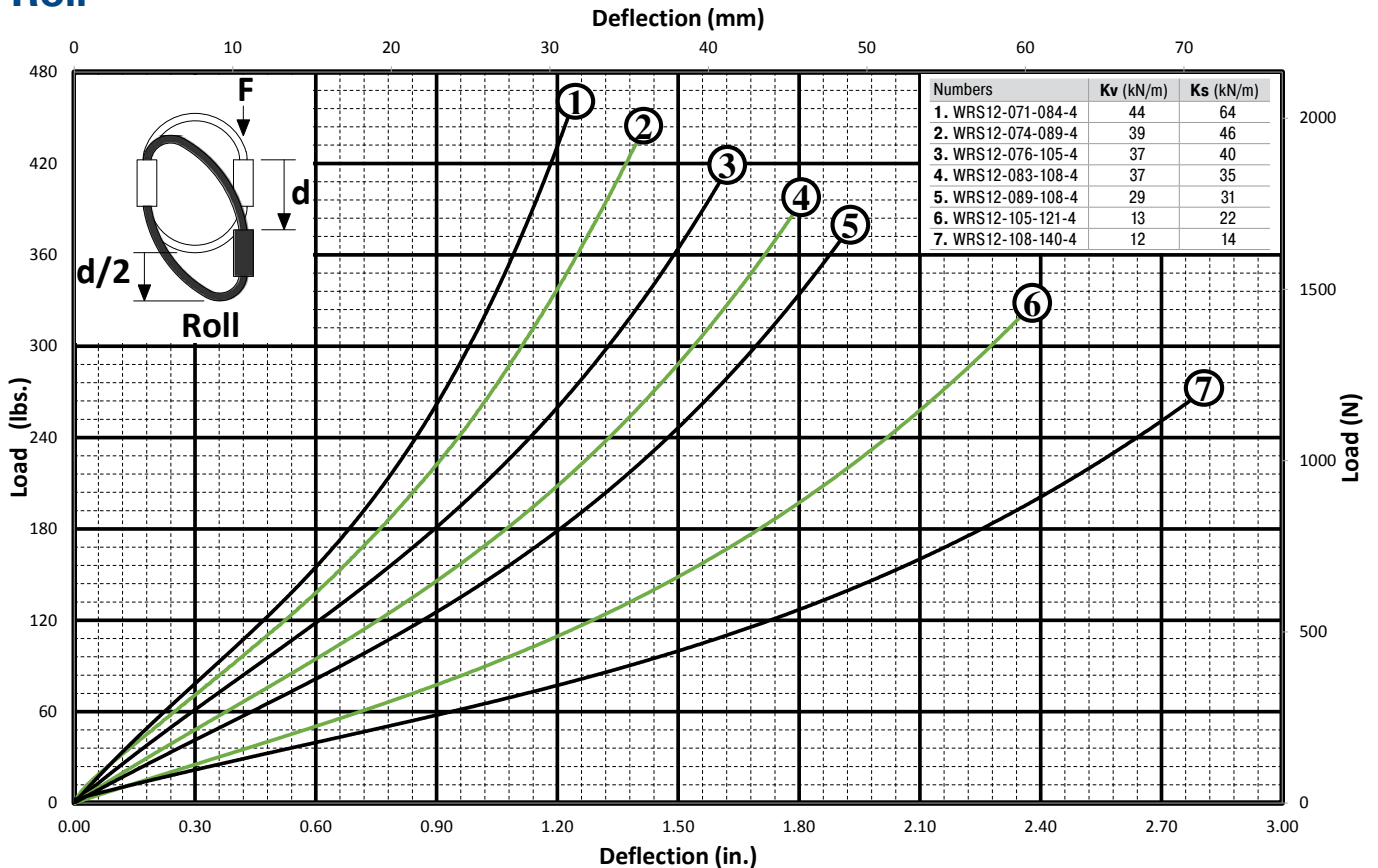

### 45° Compression/Roll

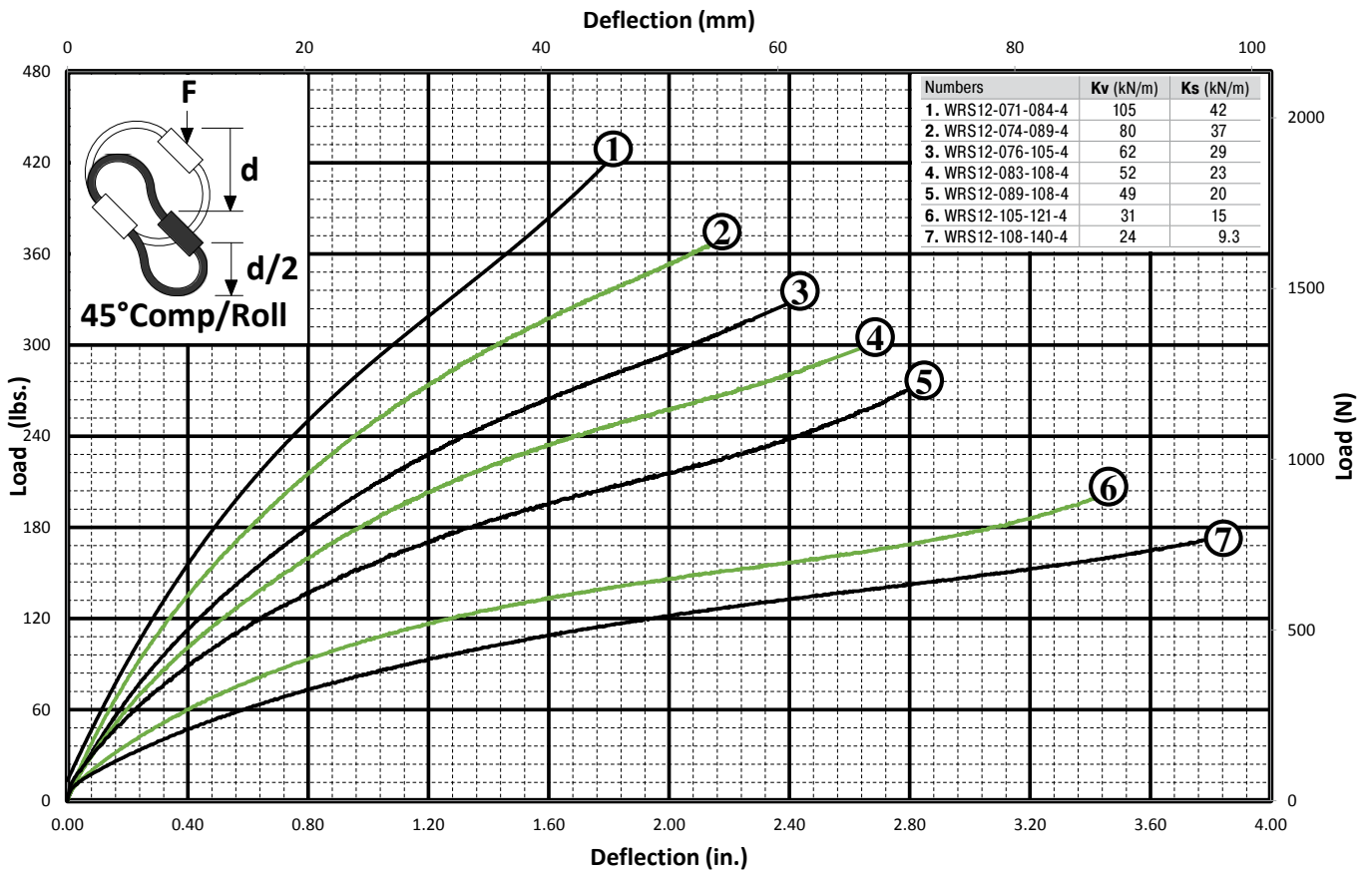

### 45° Tension/Roll

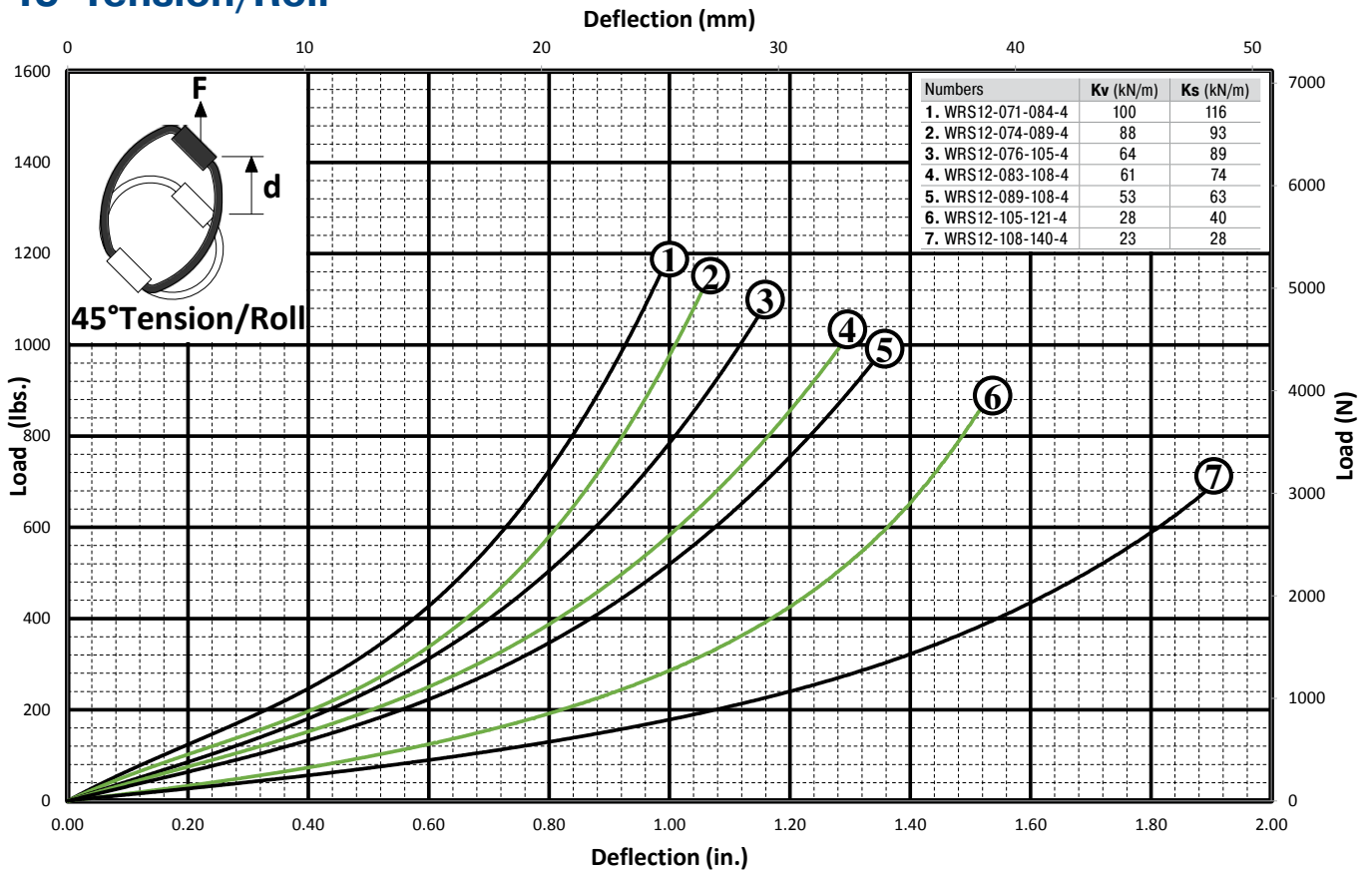

Issue 07.2020 – Specifications subject to change

# WRS16

## Helical Isolator Short

12.70 mm (1/2") Diameter Cable

### Features

- Rugged all metal construction
- Fail safe construction
- Long life and maintenance free
- Three axis capability (6 dof)
- High damping: C/cc ≈ 0.15 to 0.20

### Operating temperature range

-130°C to +260°C

### Material

- Cable: 300 Series SS per MIL-W-83420 or RR-W-410
- Screws: 300 Series SS passivated IAW ASTM A967
- Inserts: 300 Series SS (alum bars only)
- Retainer bars: Standard: 6061-T6 Alum alloy/ Chem film IAW MIL-DTL-5541, TYPE II, Class 3

### Note

- Mounting hole tolerances: ±0.25 mm
- Add 0.41 kg to Isolator weight for all stainless steel versions

### On request

- Special materials, size, mounting holes, finish, etc. available

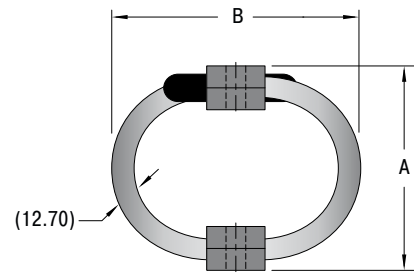
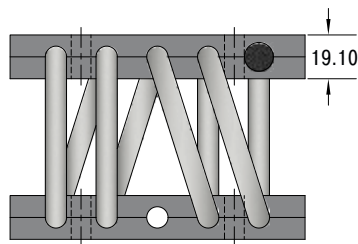
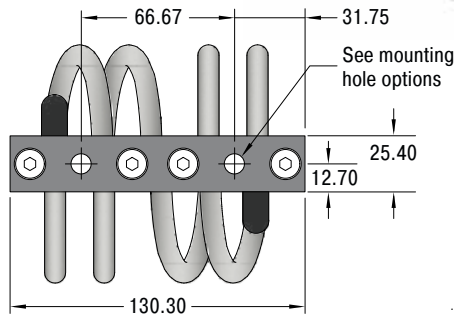

### Performance

TYPEN	A (+/- 0.8) mm	B mm	Compression			Shear/Roll (Average)			Weight kg
			Kv (Vibe) kN/m	Ks (Shock) kN/m	Deflection max. mm	Kv (Vibe) kN/m	Ks (Shock) kN/m	Deflection max. mm	
WRS16-083-102-4	82.6	101.9	218	147	35.6	113	86	35.6	0.84
WRS16-089-105-4	88.9	104.9	206	131	41.9	63	72	41.9	0.85
WRS16-095-121-4	95.3	120.7	154	91	48.3	46	52	48.3	0.93
WRS16-108-133-4	108.0	133.4	95	58	61.0	29	34	61.0	1.04
WRS16-125-144-4	124.5	143.5	68	40	77.5	22	25	77.5	1.14
WRS16-137-158-4	137.2	157.7	48	30	90.2	15	21	90.2	1.23
WRS16-155-180-4	154.9	180.3	35	19	108.0	8.2	13	108.0	1.40

### Ordering Example

WRS16-083-102-4-A

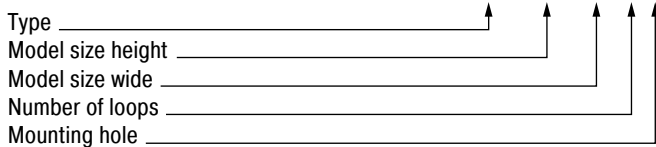

### Mounting Hole Options

<p>M8x1.25 M8x1.25</p> <p>(A)</p>	<p>M8x1.25 ø 8.74 mm</p> <p>(D)</p>
<p>ø 8.74 mm 90° ø 8.74 mm 90°</p> <p>(B)</p>	<p>ø 8.74 mm ø 8.74 mm 90°</p> <p>(E)</p>
<p>M8x1.25 ø 8.74 mm 90°</p> <p>(C)</p>	<p>ø 8.74 mm ø 8.74 mm</p> <p>(F)</p>

## Compression

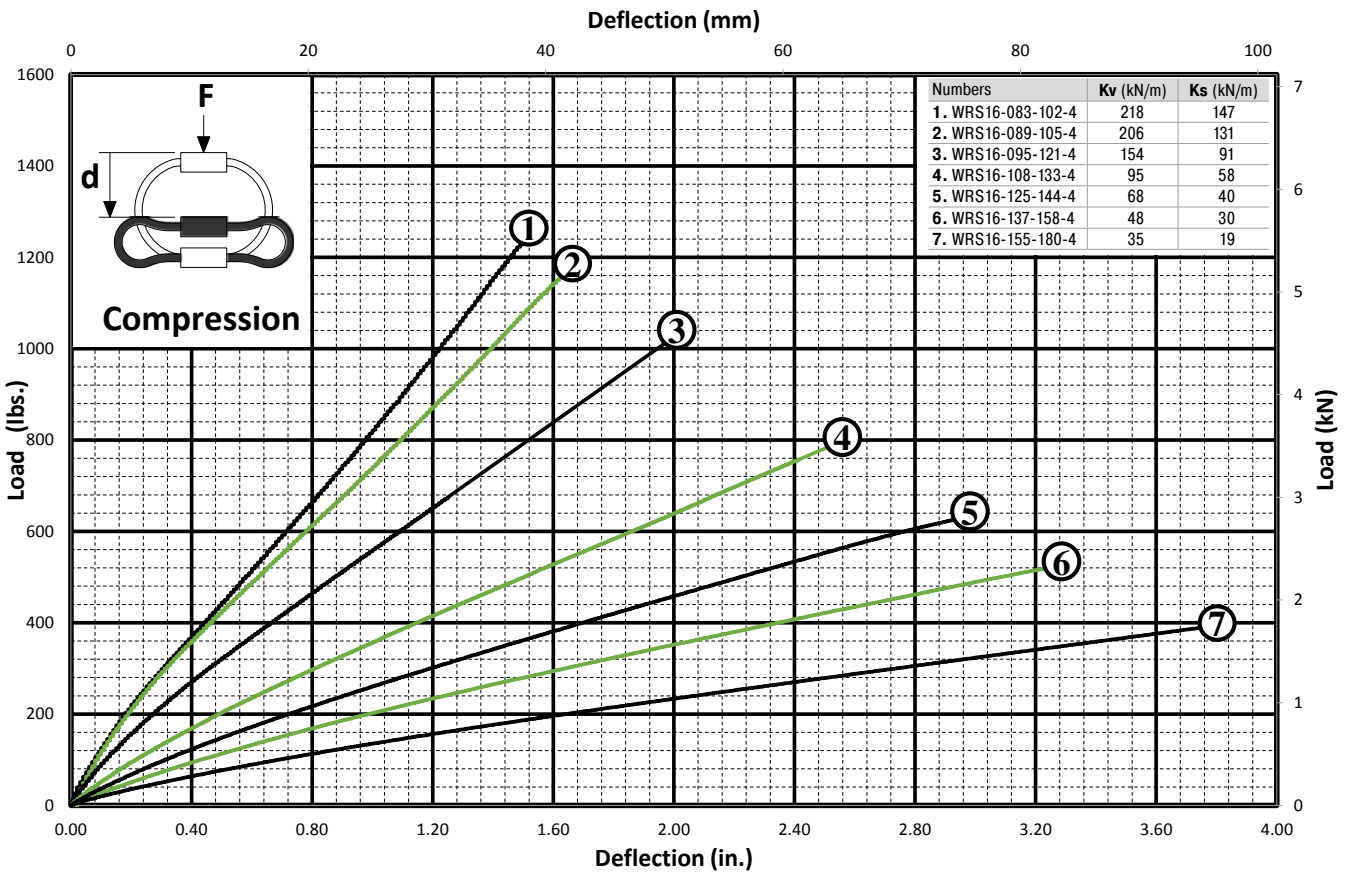

## Tension

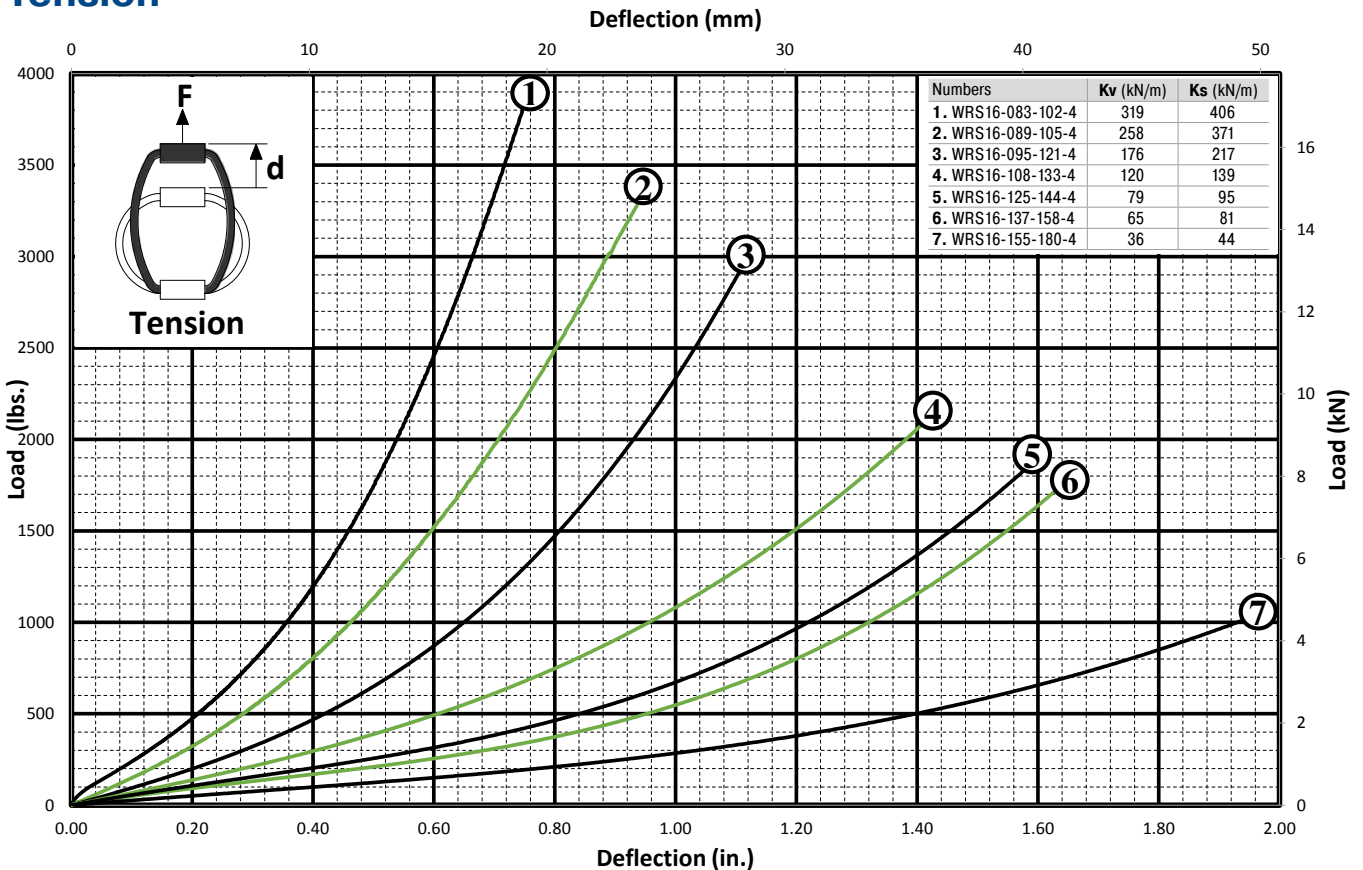

### Shear

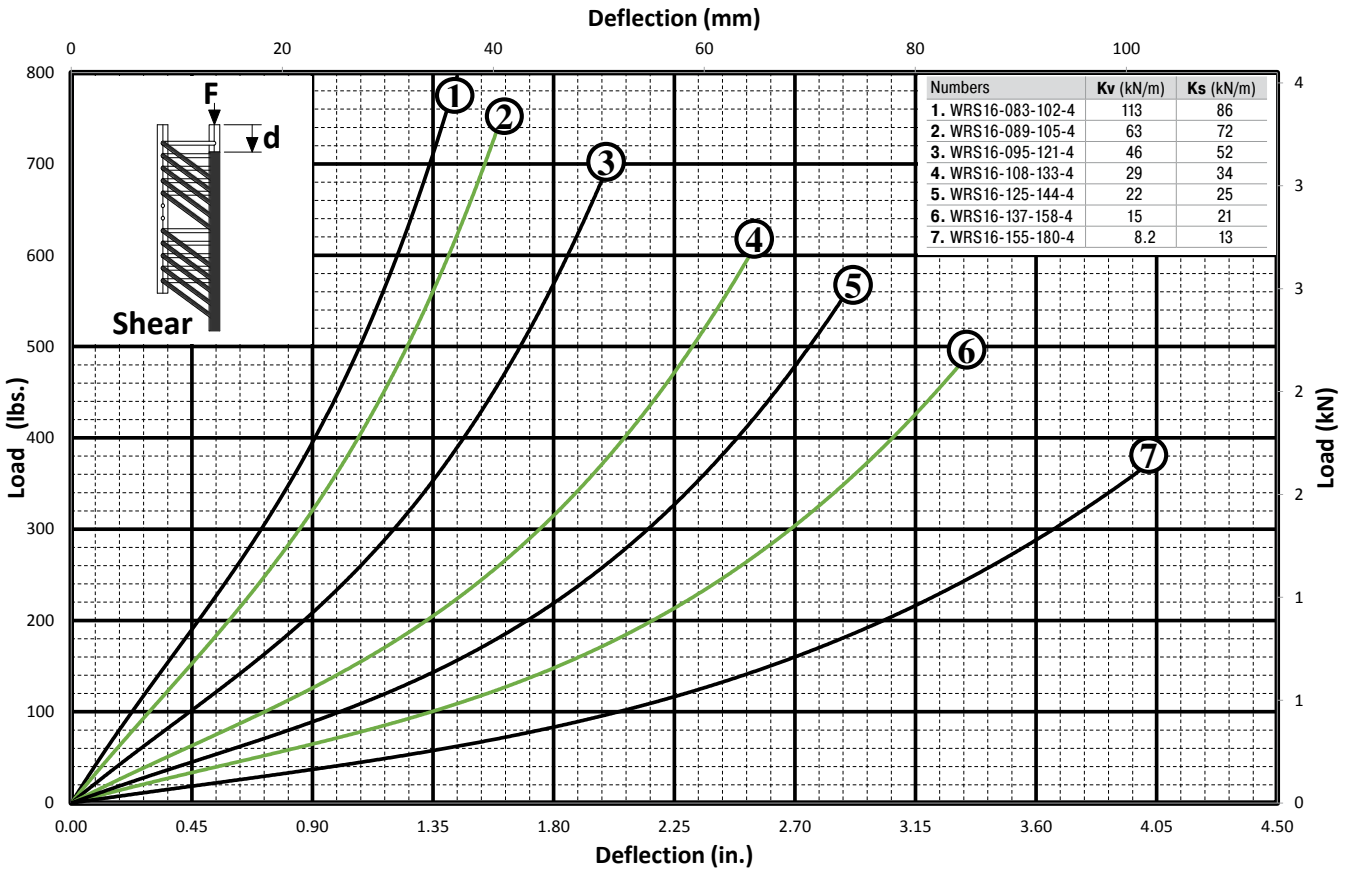

### Roll

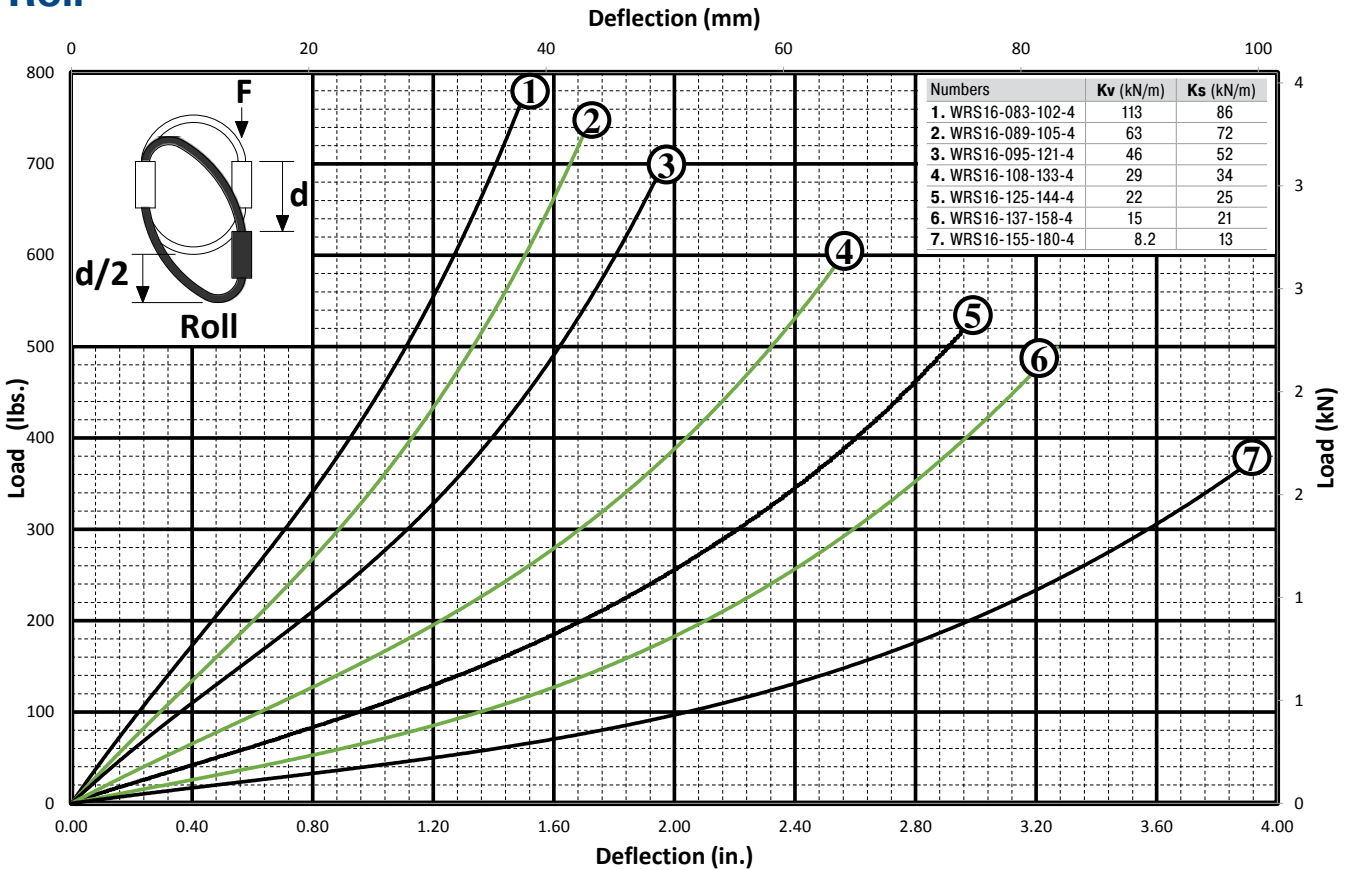



### 45° Compression/Roll

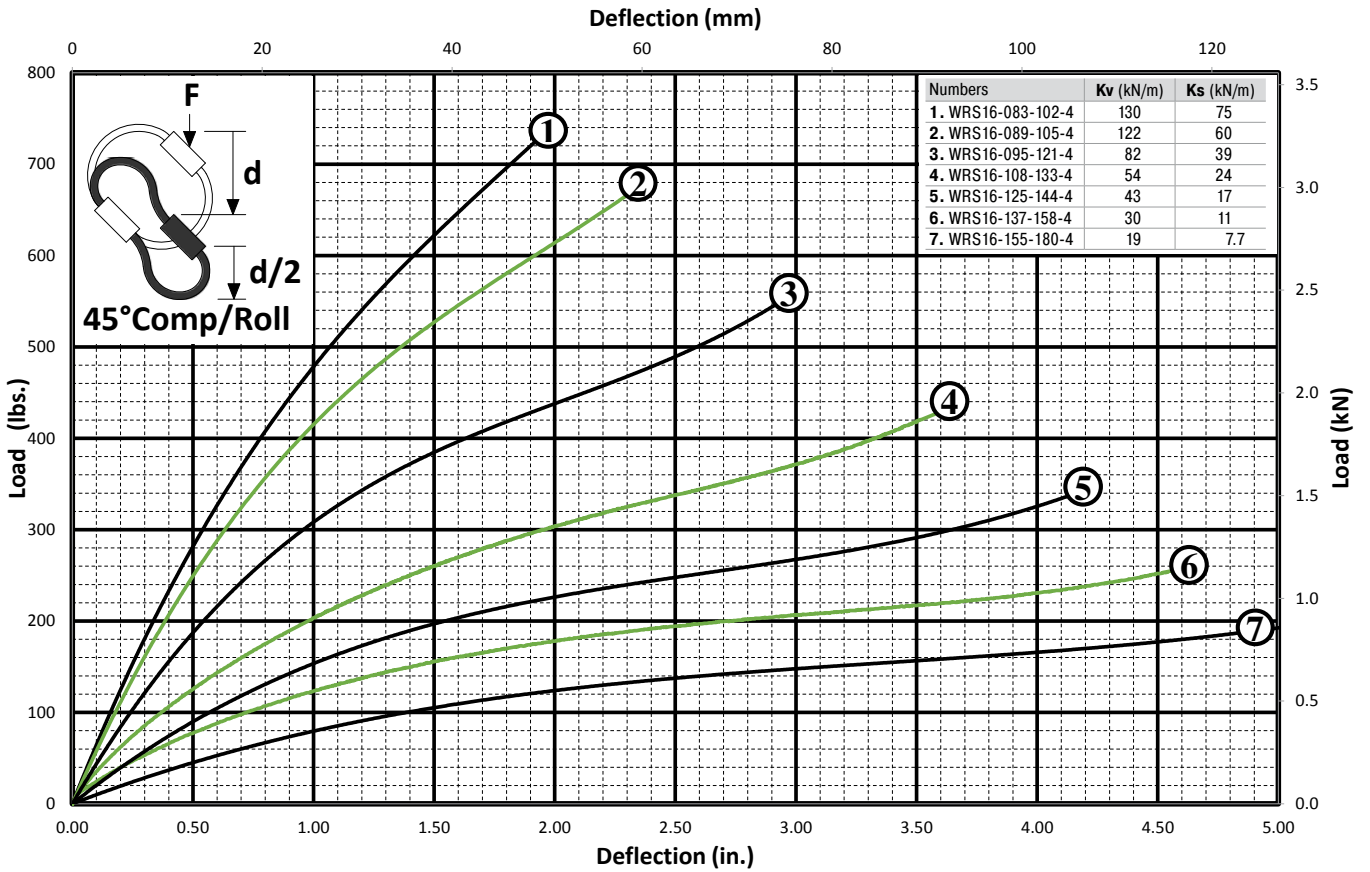

### 45° Tension/Roll

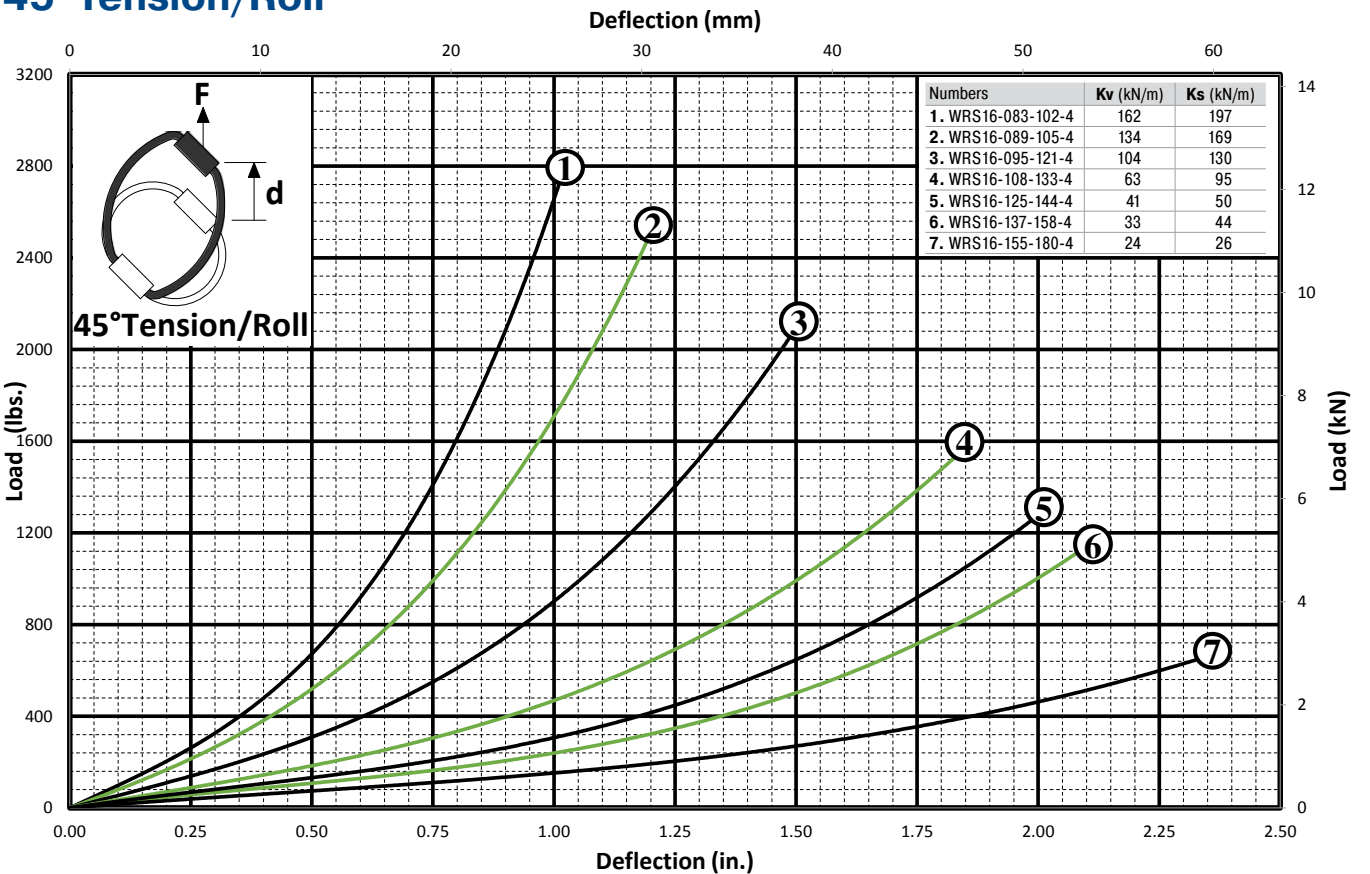

# WRS20

## Helical Isolator Short

15.88 mm (5/8") Diameter Cable

### Features

- Rugged all metal construction
- Fail safe construction
- Long life and maintenance free
- Three axis capability (6 dof)
- High damping: C/cc ≈ 0.15 to 0.20

### Operating temperature range

-130°C to +260°C

### Material

- Cable: 300 Series SS per MIL-W-83420 or RR-W-410
- Screws: 300 Series SS passivated IAW ASTM A967
- Inserts: 300 Series SS (alum bars only)
- Retainer bars: Standard: 6061-T6 Alum alloy/ Chem film IAW MIL-DTL-5541, TYPE II, Class 3

### Note

- Mounting hole tolerances: ±0.25 mm
- Add 0.61 kg to Isolator weight for all stainless steel versions

### On request

Special materials, size, mounting holes, finish, etc. available

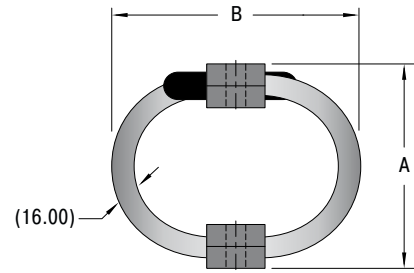
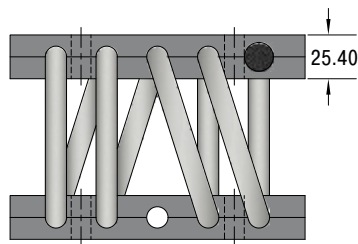
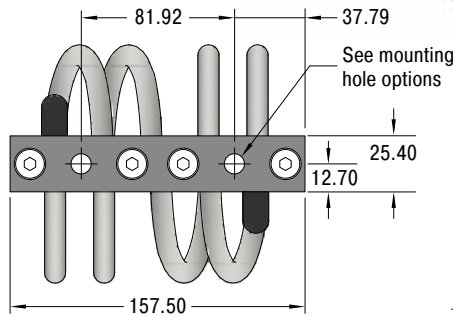

### Performance

TYPEN	A (+/- 0.8) mm	B mm	Compression			Shear/Roll (Average)			Weight kg
			Kv (Vibe) kN/m	Ks (Shock) kN/m	Deflection max. mm	Kv (Vibe) kN/m	Ks (Shock) kN/m	Deflection max. mm	
WRS20-089-102-4	88.9	101.6	614	306	30.5	189	154	30.5	1.44
WRS20-099-112-4	99.1	111.8	496	238	40.6	129	119	40.6	1.48
WRS20-109-135-4	109.2	134.6	393	154	50.8	84	79	50.8	1.59
WRS20-119-152-4	119.4	152.4	222	102	61.0	52	53	61.0	1.87
WRS20-127-165-4	127.0	165.1	178	80	68.6	49	43	68.6	1.98
WRS20-135-178-4	134.6	177.8	161	62	76.2	35	35	76.2	2.11
WRS20-152-197-4	152.4	196.8	131	43	94.0	22	24	94.0	2.32

### Ordering Example

WRS20-089-102-4-A

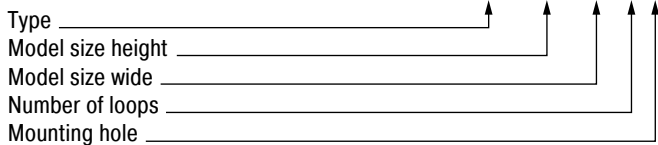

### Mounting Hole Options

<p>A</p>	<p>D</p>
<p>B</p>	<p>E</p>
<p>C</p>	<p>F</p>

Issue 07.2020 – Specifications subject to change

### Compression

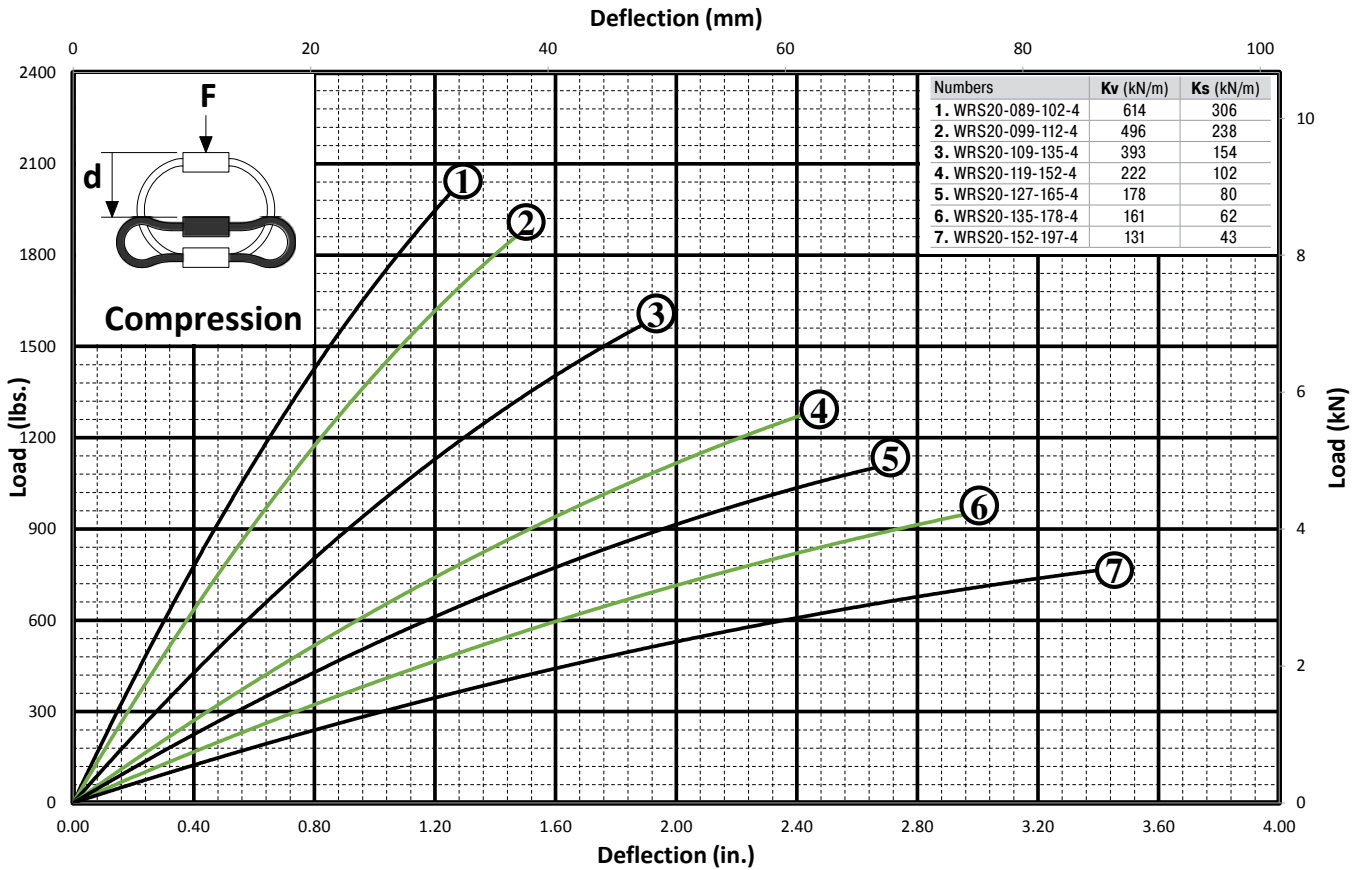

### Tension

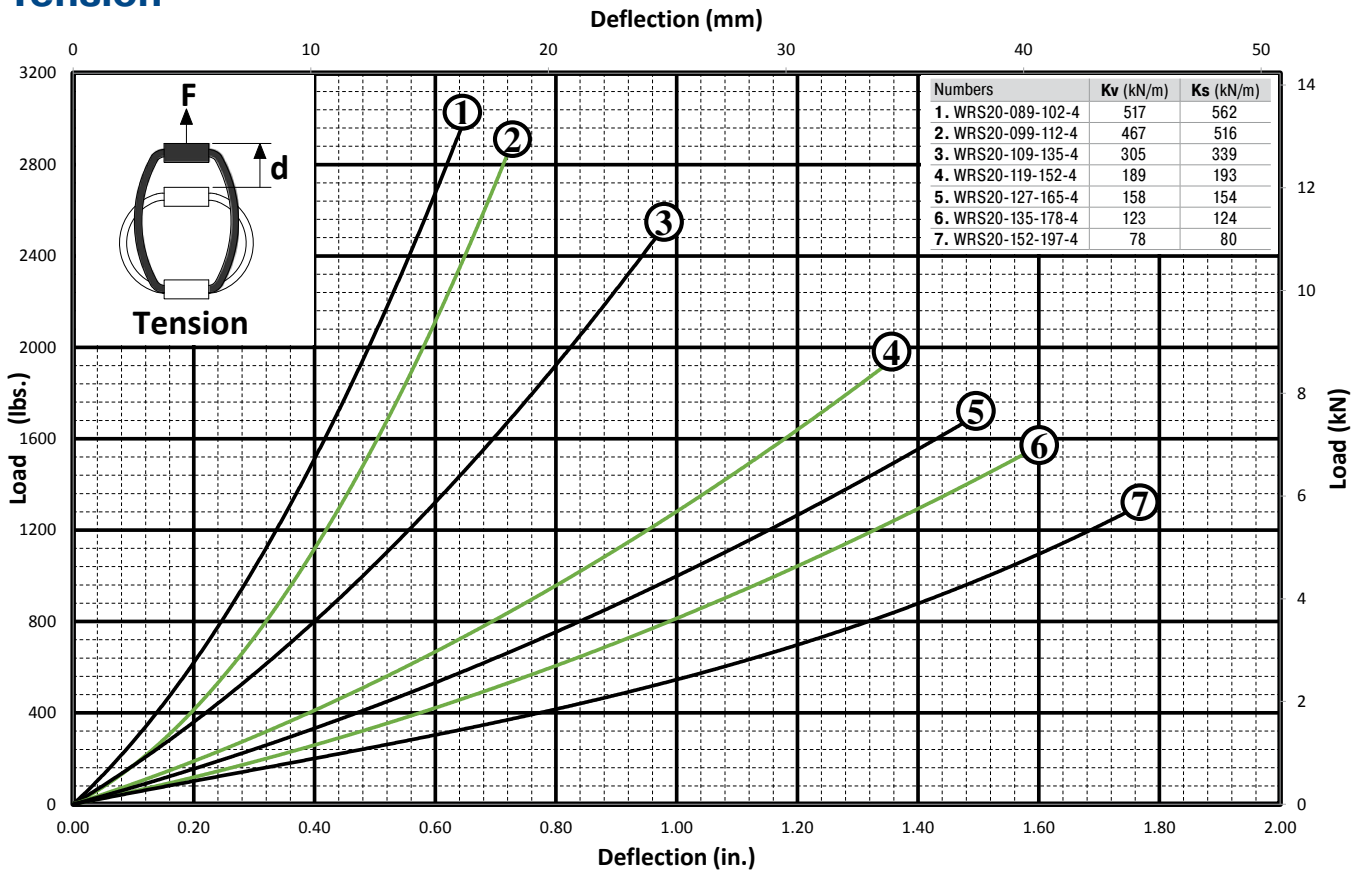

Issue 07.2020 – Specifications subject to change

Helical Isolator Short, 15.88 mm (5/8") Diameter Cable

### Shear

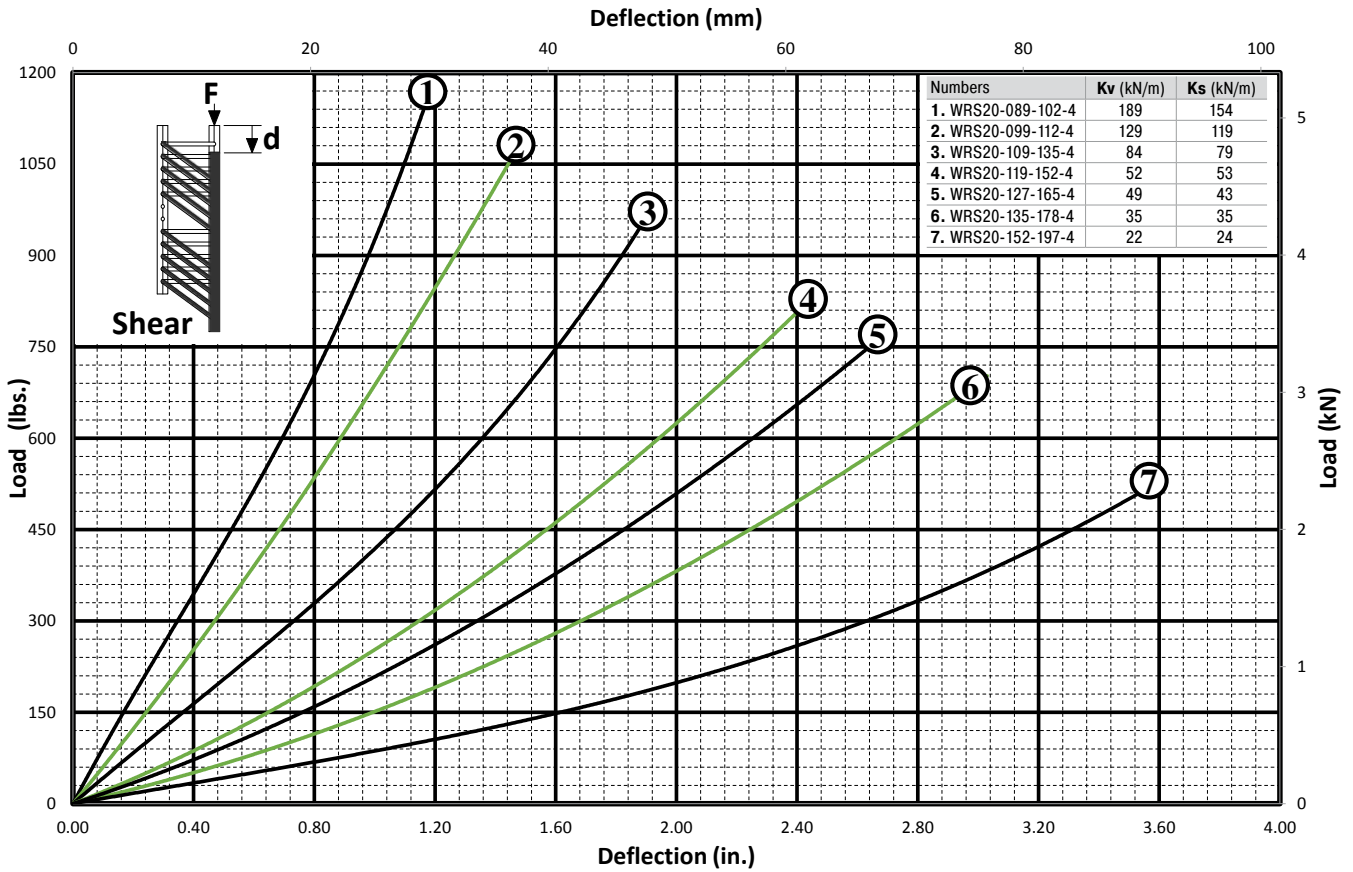

### Roll

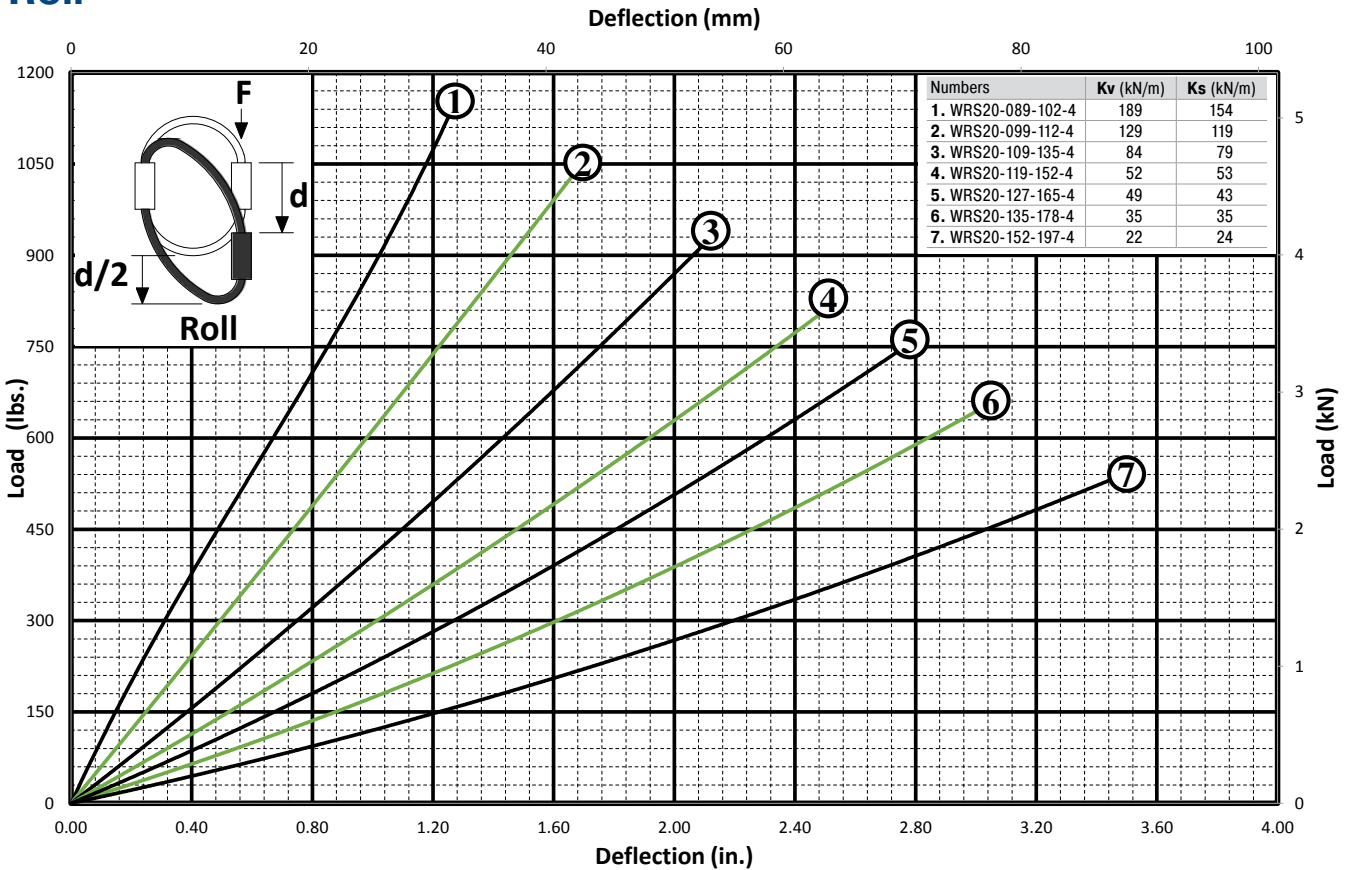

### 45° Compression/Roll

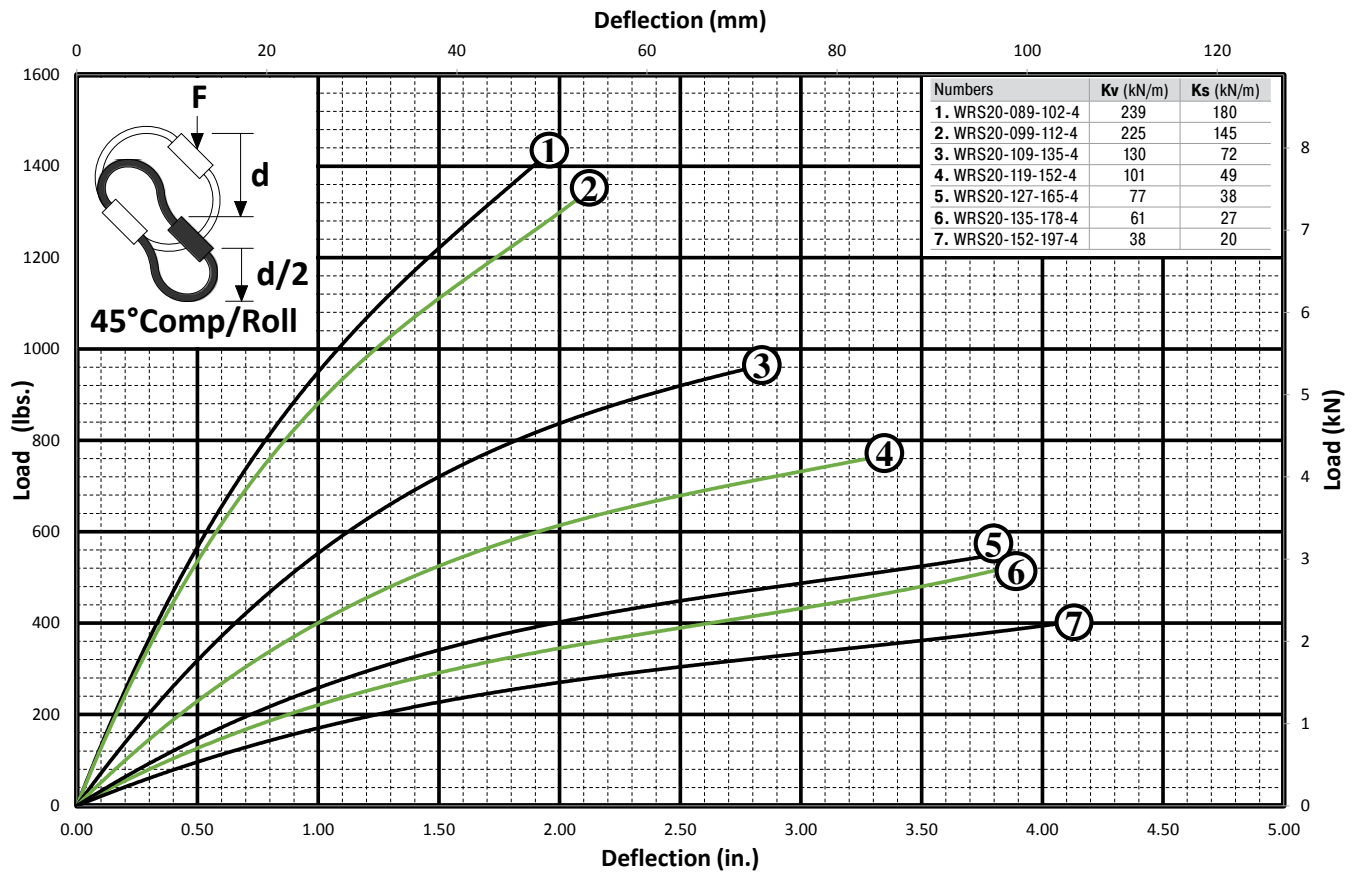

### 45° Tension/Roll

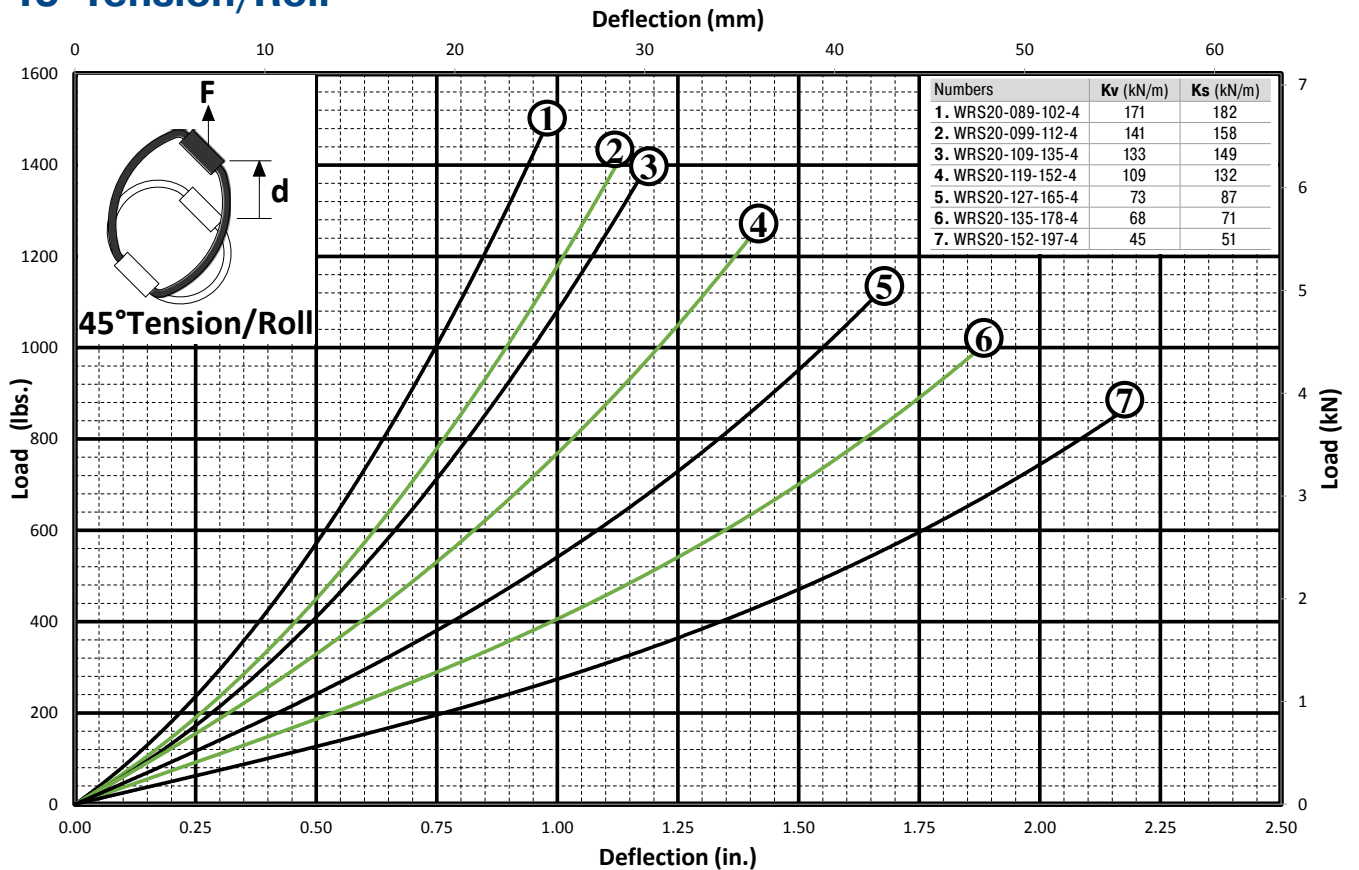



# WRS24

## Helical Isolator Short

### 19.05 mm (3/4") Diameter Cable

#### Features

- Rugged all metal construction
- Fail safe construction
- Long life and maintenance free
- Three axis capability (6 dof)
- High damping: C/cc ≈ 0.15 to 0.20

#### Operating temperature range

-130°C to +260°C

#### Material

- Cable: 300 Series SS per MIL-W-83420 or RR-W-410
- Screws: 300 Series SS passivated IAW ASTM A967
- Inserts: 300 Series SS (alum bars only)
- Retainer bars: Standard: 6061-T6 Alum alloy/ Chem film IAW MIL-DTL-5541, TYPE II, Class 3

#### Note

- Mounting hole tolerances: ±0.25 mm
- Add 0.92 kg to Isolator weight for all stainless steel versions

#### On request

- Special materials, size, mounting holes, finish, etc. available

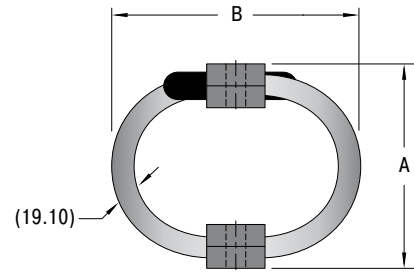
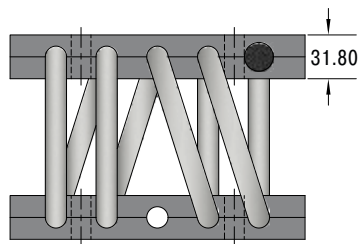
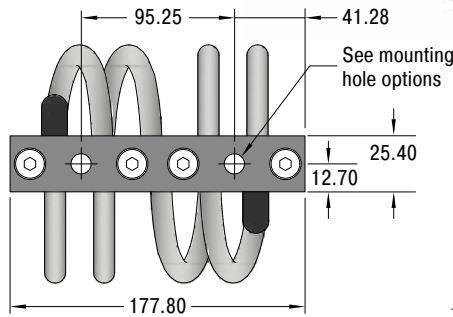

#### Performance

TYPEN	A (+/- 0.8) mm	B mm	Compression			Shear/Roll (Average)			Weight kg
			Kv (Vibe) kN/m	Ks (Shock) kN/m	Deflection max. mm	Kv (Vibe) kN/m	Ks (Shock) kN/m	Deflection max. mm	
WRS24-102-108-4	101.6	108.0	549	334	30.5	210	221	30.5	2.38
WRS24-112-118-4	111.8	118.1	471	322	40.6	203	191	40.6	2.53
WRS24-122-140-4	121.9	139.7	404	226	50.8	153	128	50.8	2.72
WRS24-131-159-4	131.1	158.8	354	183	61.0	106	100	61.0	2.87
WRS24-140-172-4	139.7	171.5	294	155	68.6	89	94	68.6	2.97
WRS24-152-210-4	152.4	209.6	211	117	81.3	67	71	81.3	3.11

#### Ordering Example

WRS24-102-108-4-A

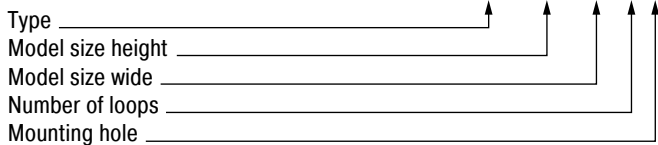

#### Mounting Hole Options

<p>A</p>	<p>D</p>
<p>B</p>	<p>E</p>
<p>C</p>	<p>F</p>

## Compression

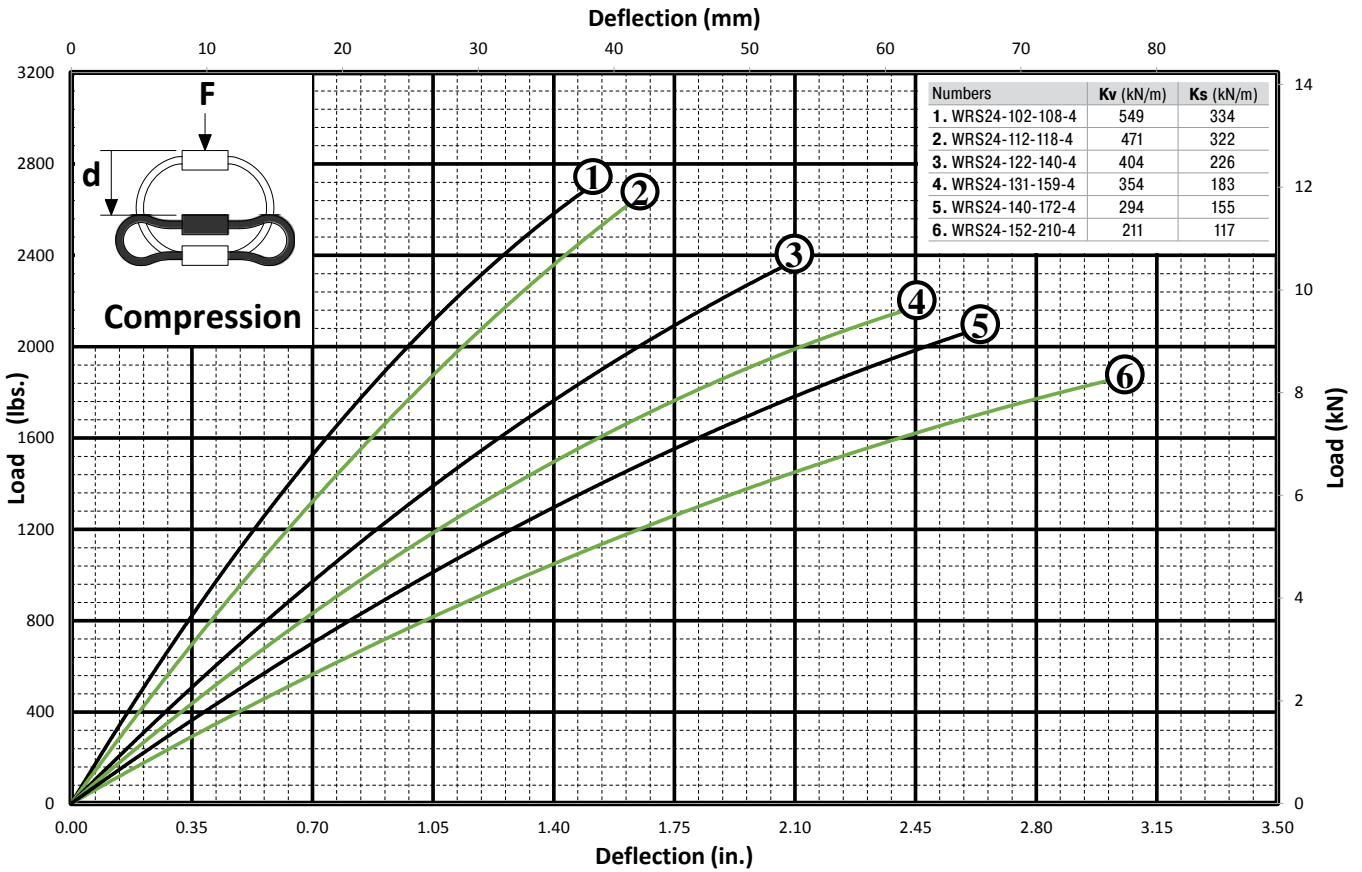

## Tension

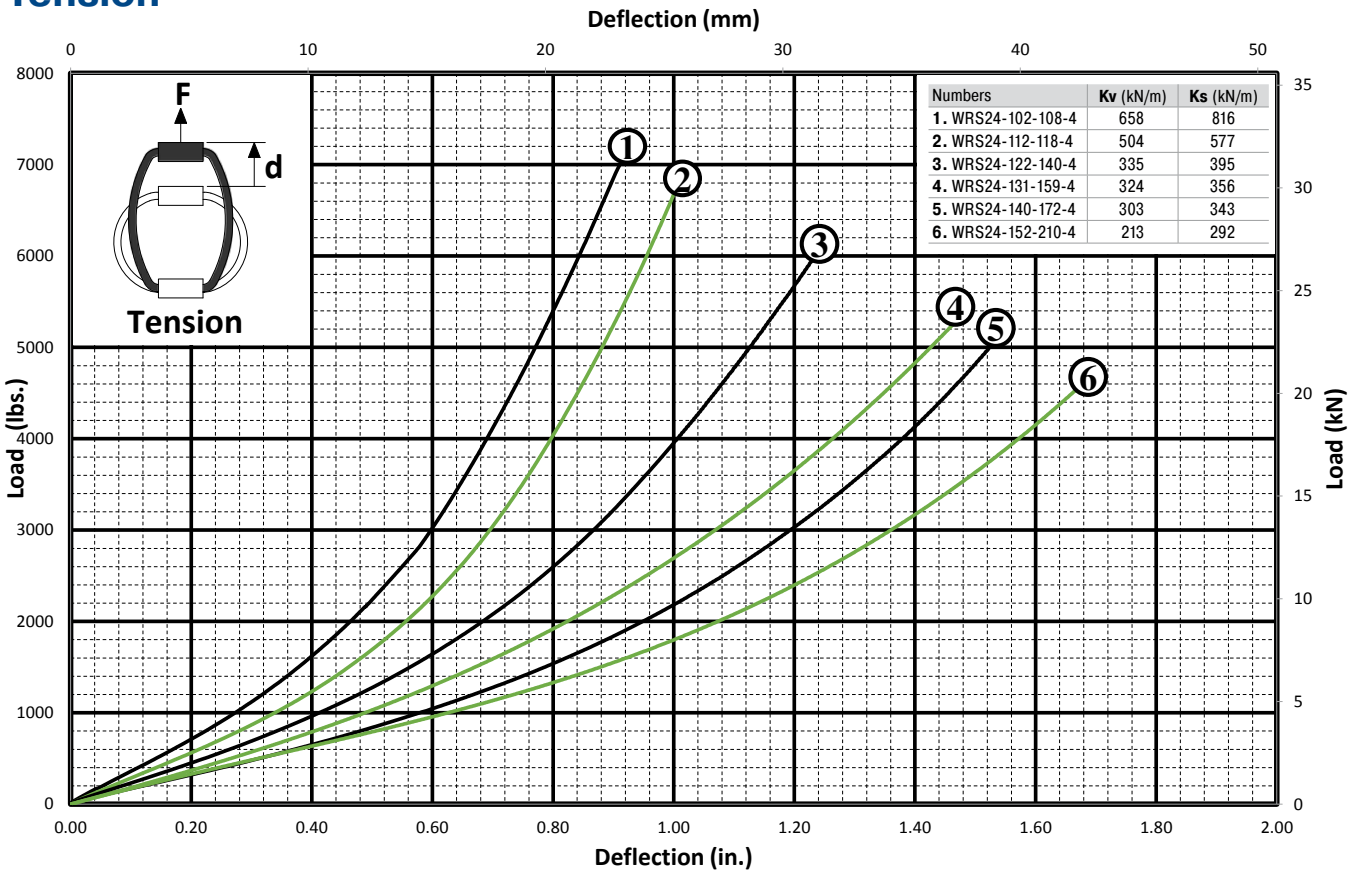

### Shear

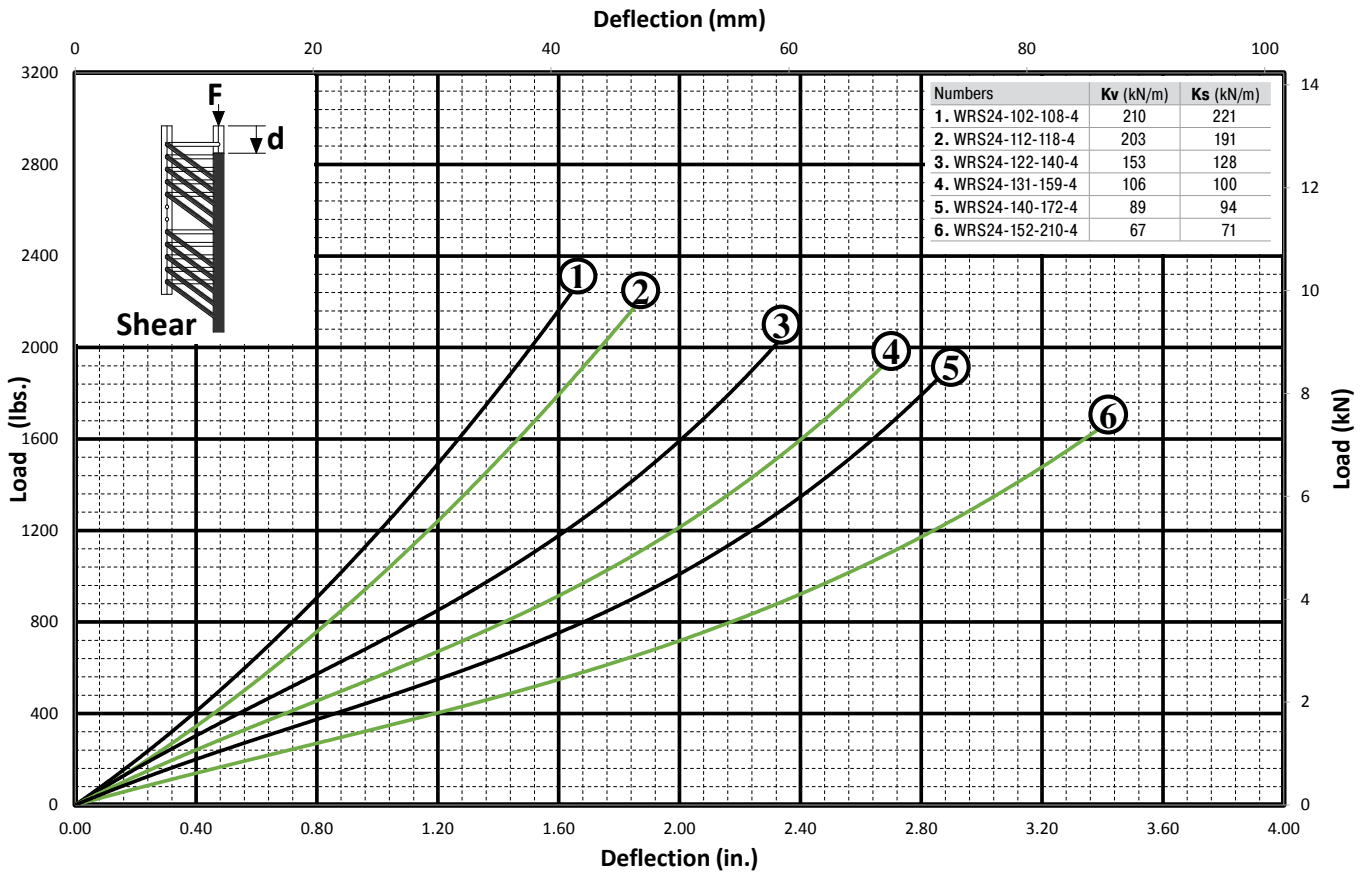

### Roll

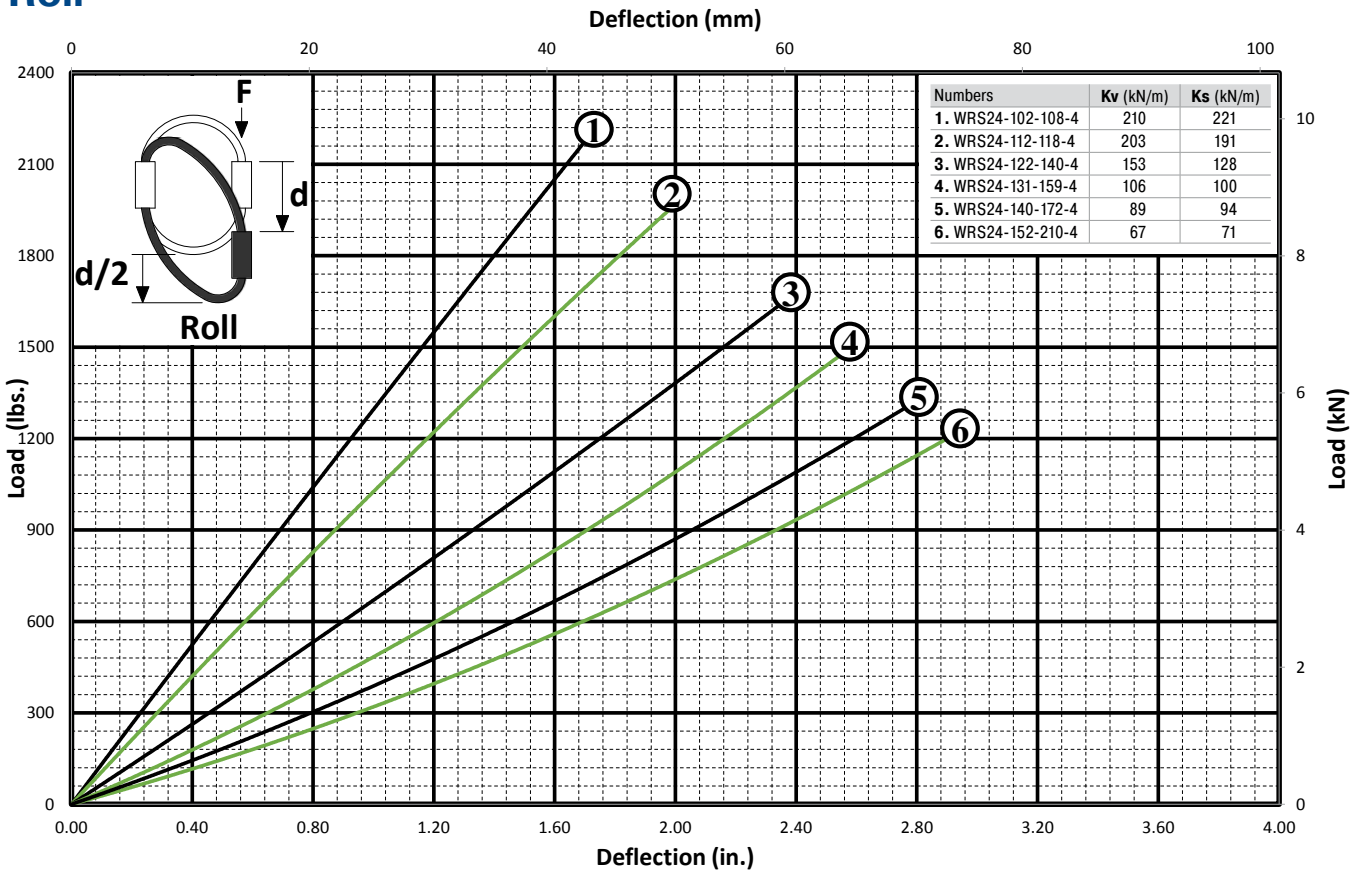

### 45° Compression/Roll

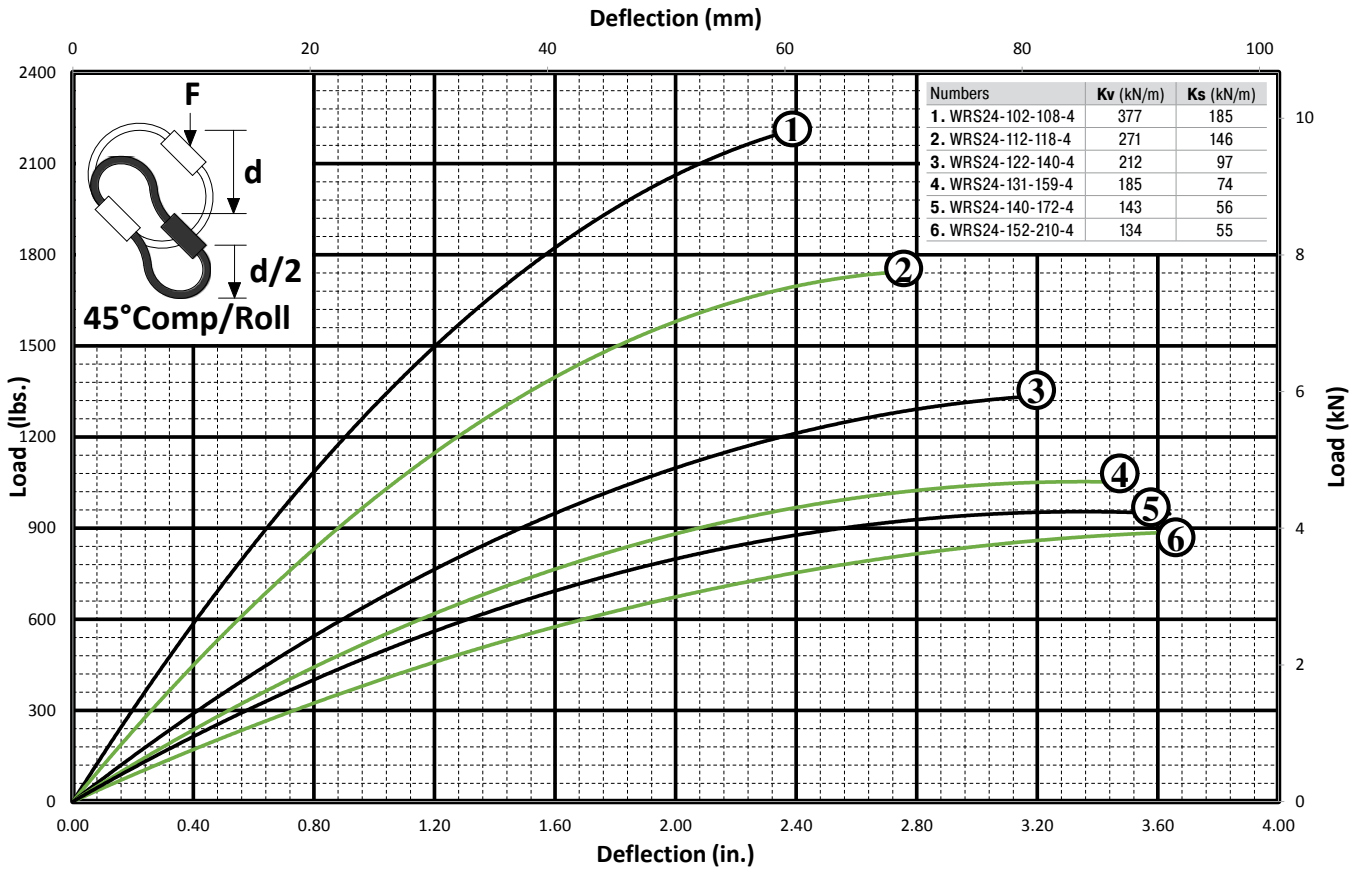

### 45° Tension/Roll

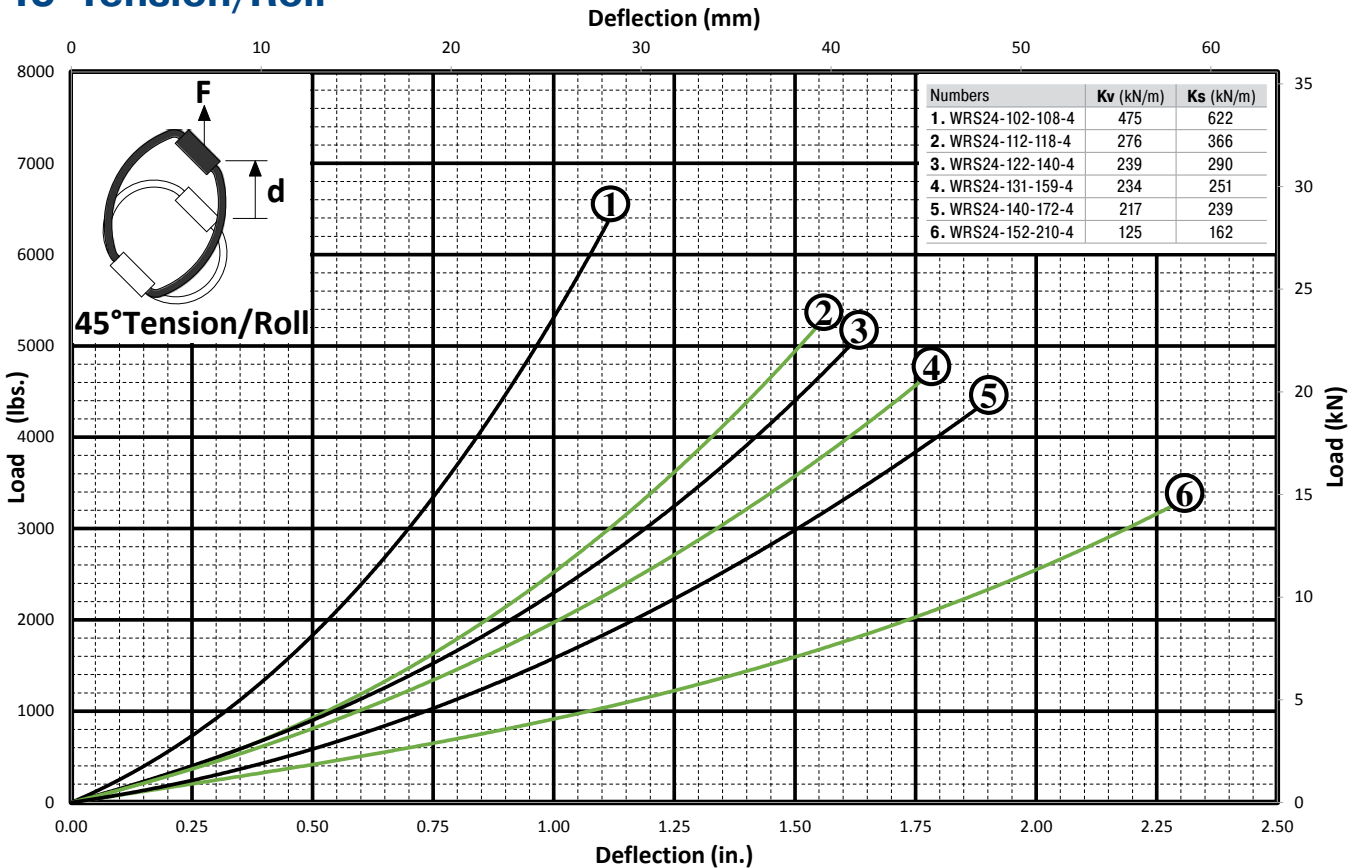

Product also available in stainless steel



# WRS28

## Helical Isolator Short

22.23 mm (7/8") Diameter Cable



### Features

- Rugged all metal construction
- Fail safe construction
- Long life and maintenance free
- Three axis capability (6 dof)
- High damping: C/cc ≈ 0.15 to 0.20

### Operating temperature range

-130°C to +260°C

### Material

- Cable: 300 Series SS per MIL-W-83420 or RR-W-410
- Screws: 300 Series SS passivated IAW ASTM A967
- Inserts: 300 Series SS (alum bars only)
- Retainer bars: Standard: 6061-T6 Alum alloy/ Chem film IAW MIL-DTL-5541, TYPE II, Class 3

### Note

- Mounting hole tolerances: ±0.25 mm
- Add 2.05 kg to Isolator weight for all stainless steel versions

### On request

Special materials, size, mounting holes, finish, etc. available

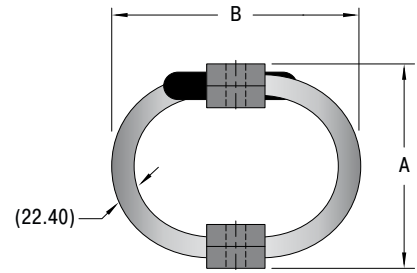
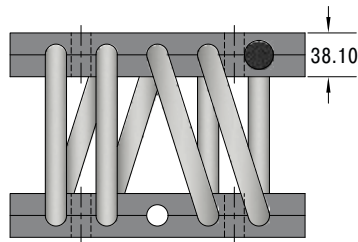
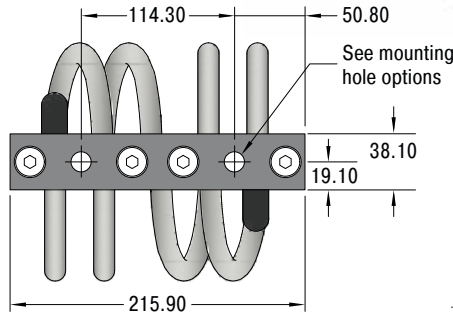

### Performance

TYPEN	A (+/- 0.8) mm	B mm	Compression			Shear/Roll (Average)			Weight kg
			Kv (Vibe) kN/m	Ks (Shock) kN/m	Deflection max. mm	Kv (Vibe) kN/m	Ks (Shock) kN/m	Deflection max. mm	
WRS28-133-172-4	133.4	171.5	547	363	45.7	173	187	45.7	4.54
WRS28-152-178-4	152.4	177.8	484	326	66.0	139	154	66.0	4.84
WRS28-159-184-4	158.8	184.2	368	241	71.1	122	136	71.1	4.91
WRS28-178-197-4	177.8	196.9	258	166	88.9	68	76	88.9	5.42
WRS28-191-210-4	190.5	209.6	222	119	101.6	58	64	101.6	5.70
WRS28-216-235-4	215.9	235.0	161	78	127.0	41	44	127.0	6.10

### Ordering Example

WRS28-133-172-4-A

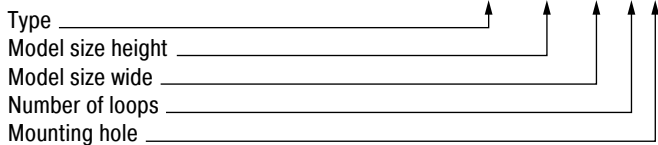

### Mounting Hole Options

<p>A</p>	<p>D</p>
<p>B</p>	<p>E</p>
<p>C</p>	<p>F</p>

Issue 07.2020 – Specifications subject to change



### Compression

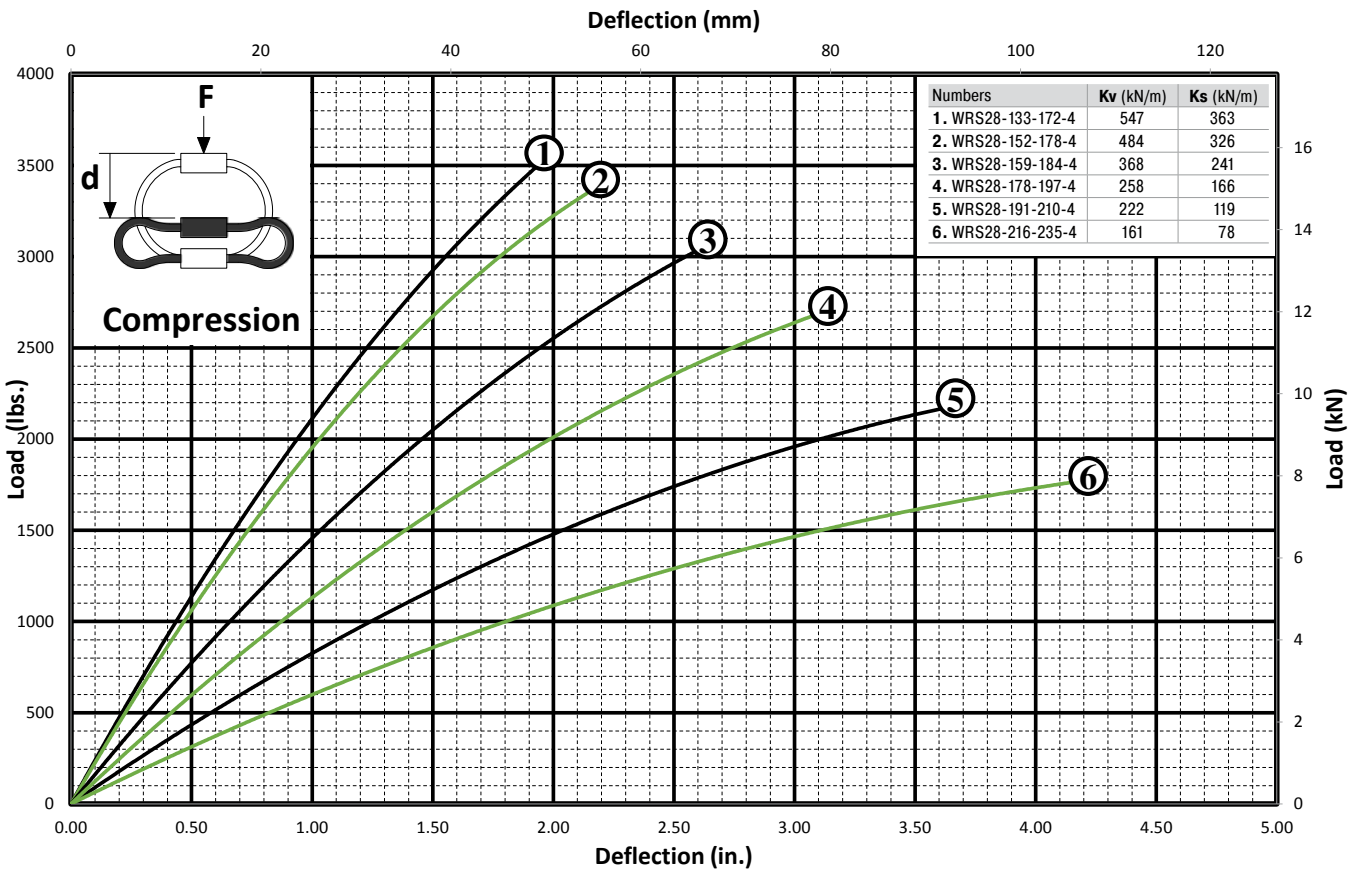

### Tension

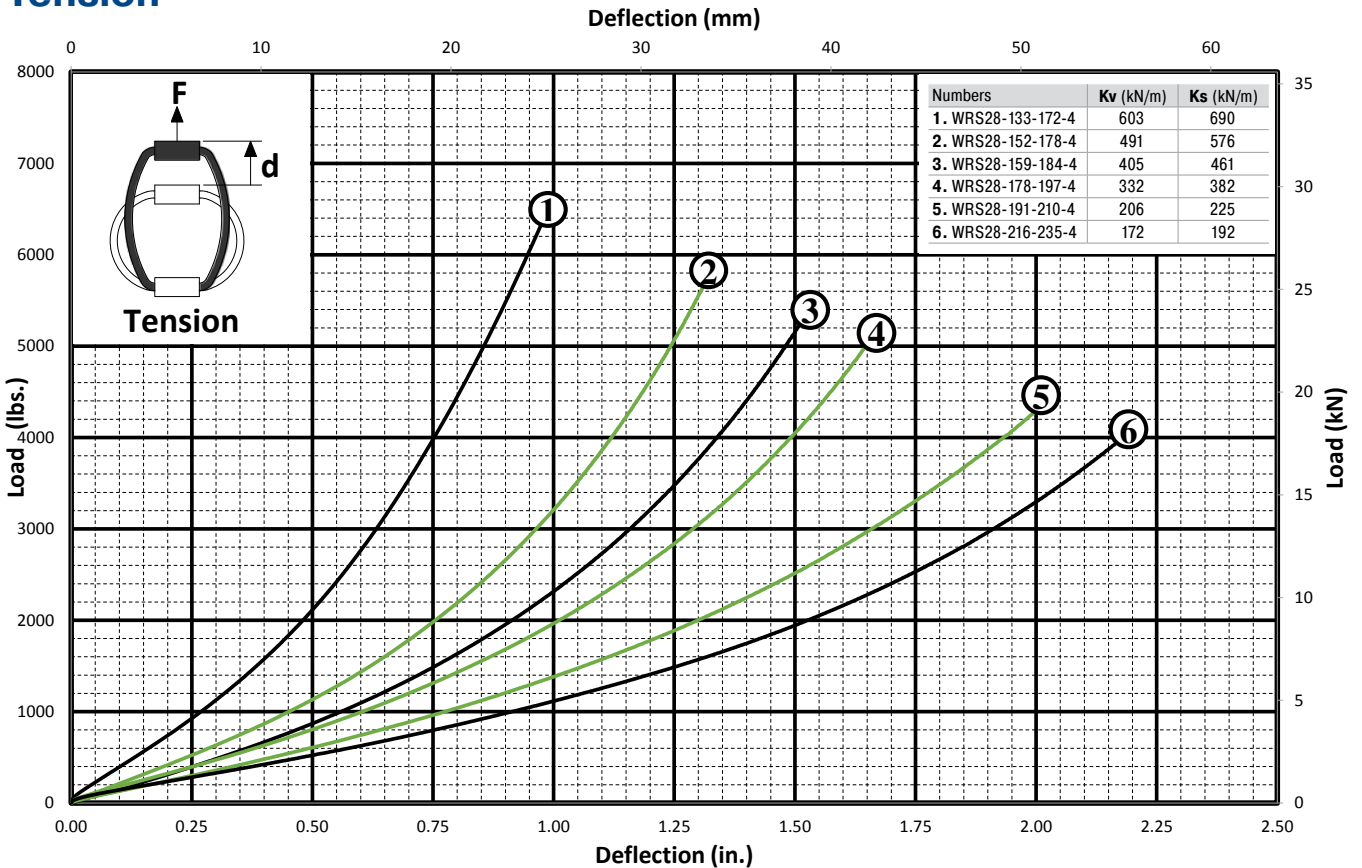

Issue 07.2020 – Specifications subject to change

Helical Isolator Short, 22.23 mm (7/8") Diameter Cable

### Shear

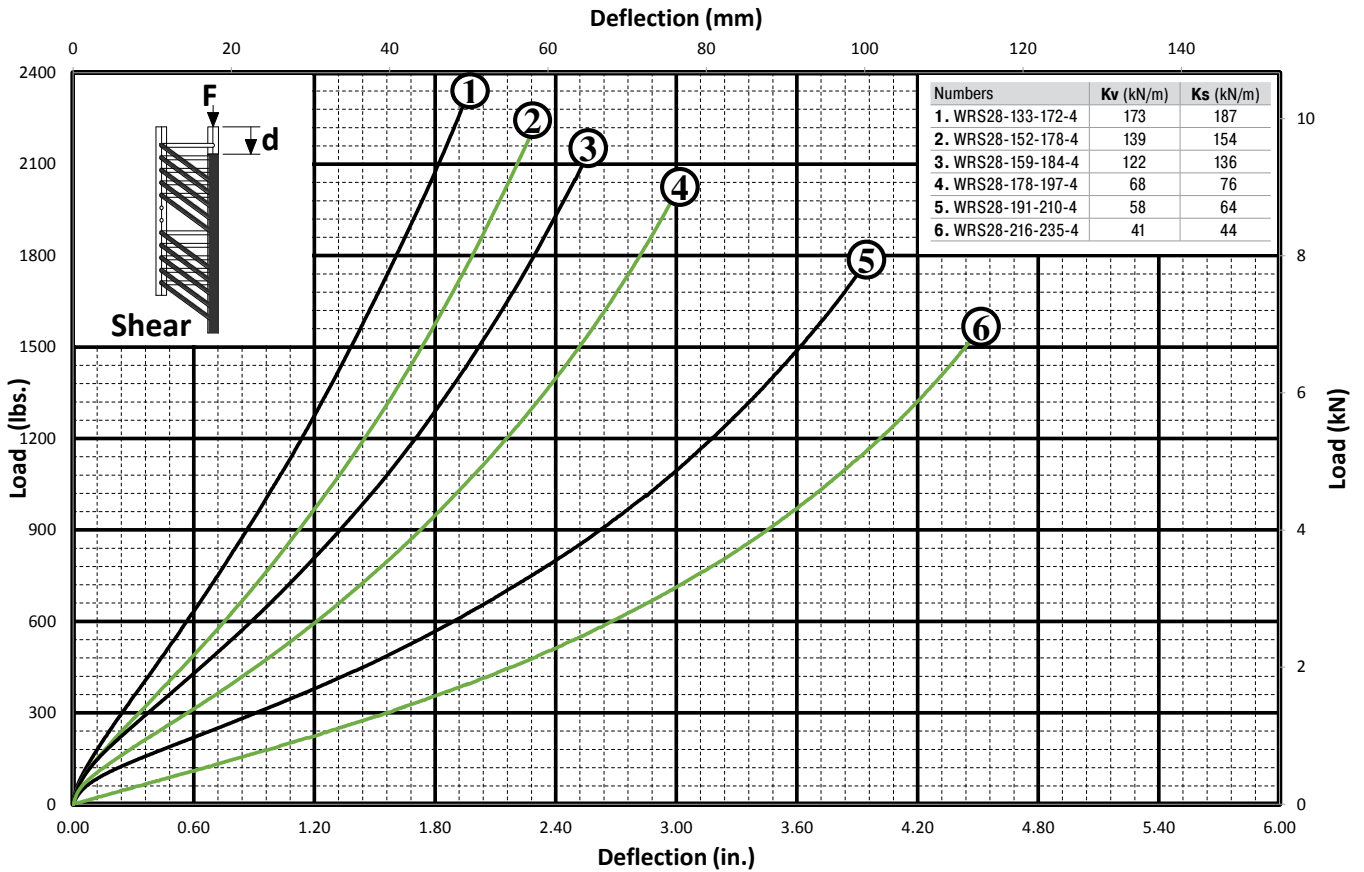

### Roll

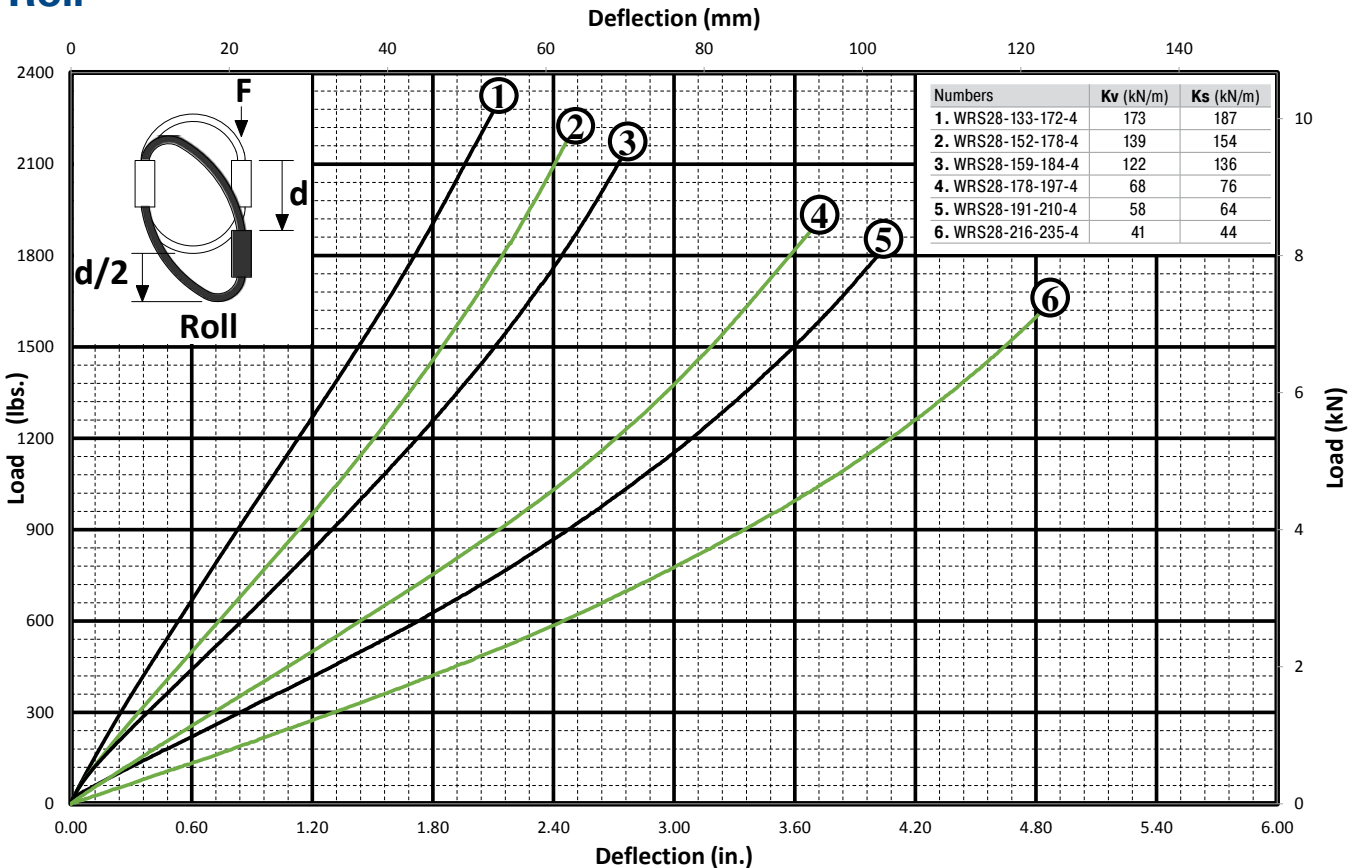

Issue 07.2020 – Specifications subject to change

### 45° Compression/Roll

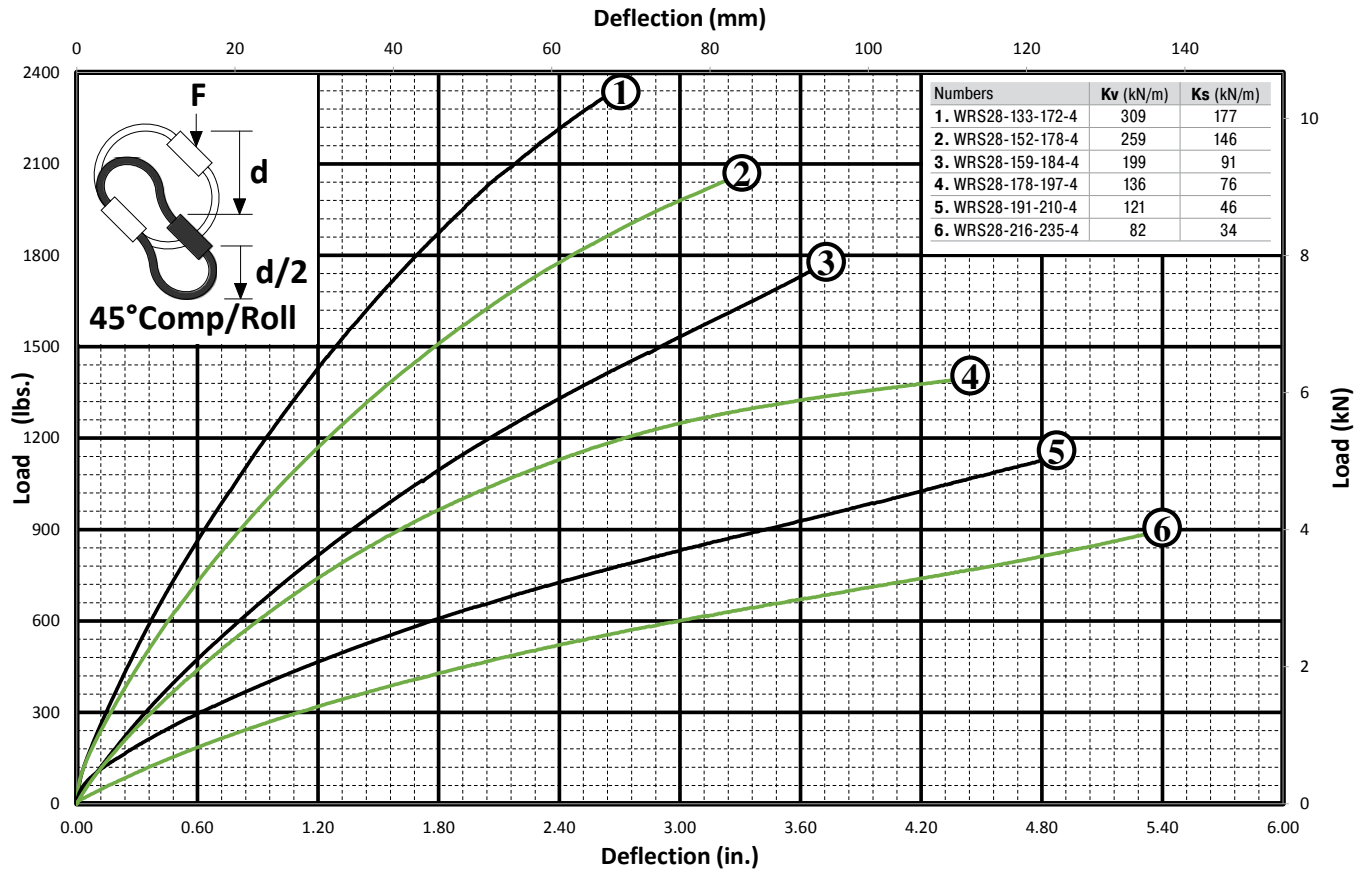

### 45° Tension/Roll

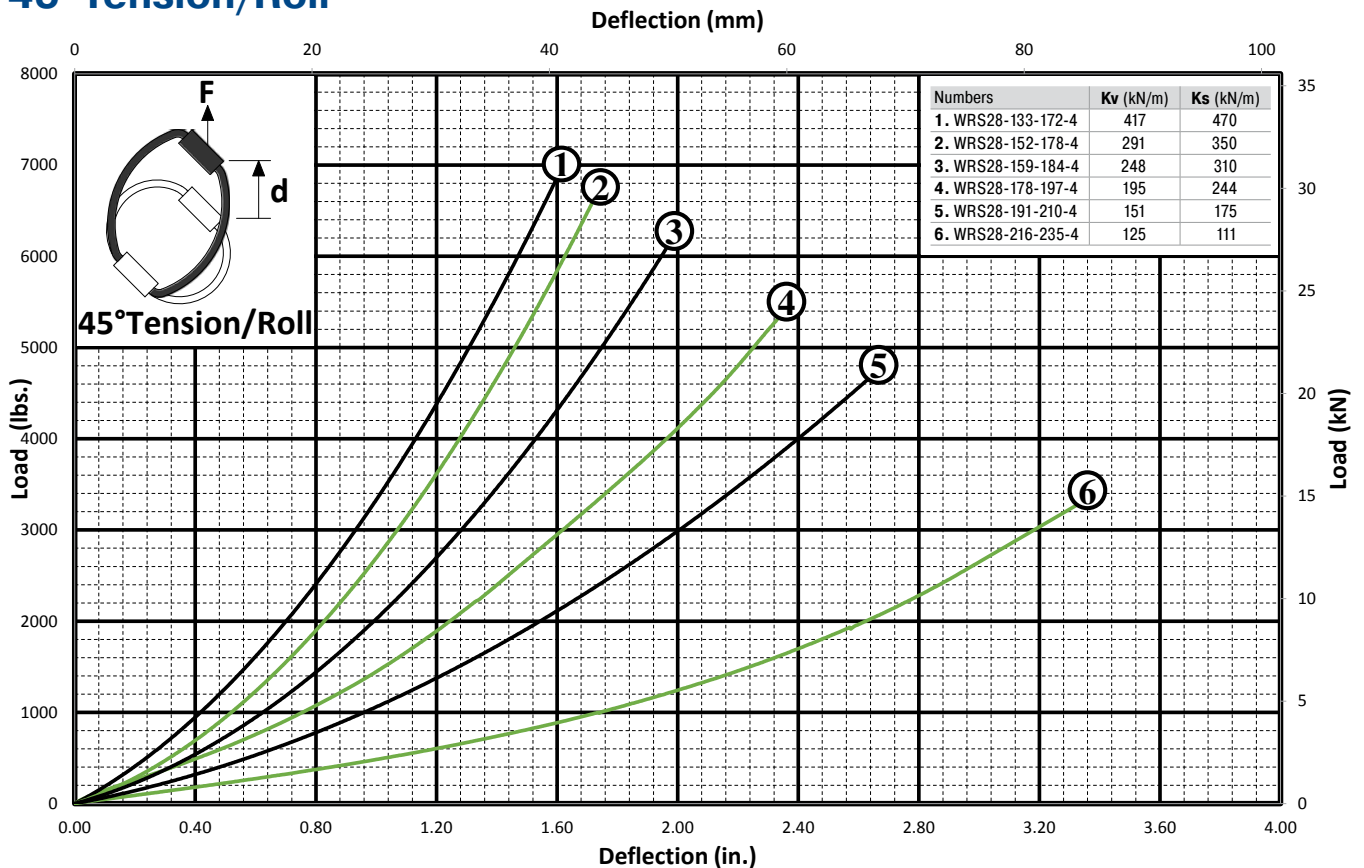

Issue 07.2020 – Specifications subject to change

# WRS32

## Helical Isolator Short

### 25.40 mm (1") Diameter Cable



**Features**

- Rugged all metal construction
- Fail safe construction
- Long life and maintenance free
- Three axis capability (6 dof)
- High damping: C/cc ≈ 0.15 to 0.20

**Operating temperature range**

-130°C to +260°C

**Material**

- Cable: 300 Series SS per MIL-W-83420 or RR-W-410
- Screws: 300 Series SS passivated IAW ASTM A967
- Inserts: 300 Series SS (alum bars only)
- Retainer bars: Standard: 6061-T6 Alum alloy/ Chem film IAW MIL-DTL-5541, TYPE II, Class 3

**Note**

- Mounting hole tolerances: ±0.25 mm
- Add 1.87 kg to Isolator weight for all stainless steel versions

**On request**

Special materials, size, mounting holes, finish, etc. available

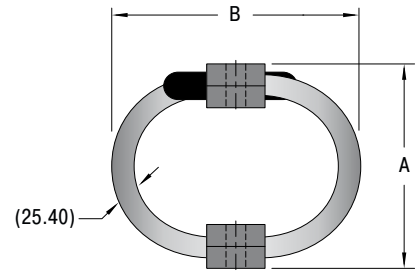
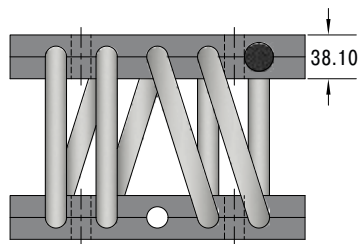
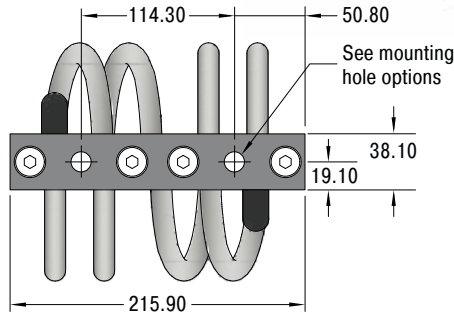

**Performance**

TYPEN	A (+/- 0.8) mm	B mm	Compression			Shear/Roll (Average)			Weight kg
			Kv (Vibe) kN/m	Ks (Shock) kN/m	Deflection max. mm	Kv (Vibe) kN/m	Ks (Shock) kN/m	Deflection max. mm	
WRS32-133-178-4	133.4	177.8	950	541	45.7	425	280	45.7	5.66
WRS32-152-184-4	152.4	184.2	804	457	66.0	333	225	66.0	5.86
WRS32-159-191-4	158.8	190.5	655	363	71.1	319	210	71.1	6.04
WRS32-178-203-4	177.8	203.2	375	205	88.9	228	153	88.9	6.45
WRS32-191-216-4	190.5	215.9	331	184	101.6	179	110	101.6	7.08
WRS32-216-241-4	215.9	241.3	251	138	127.0	125	80	127.0	7.67

**Ordering Example**

WRS32-133-178-4-A

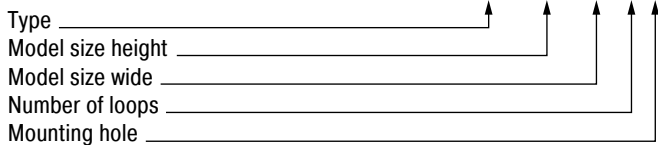

**Mounting Hole Options**

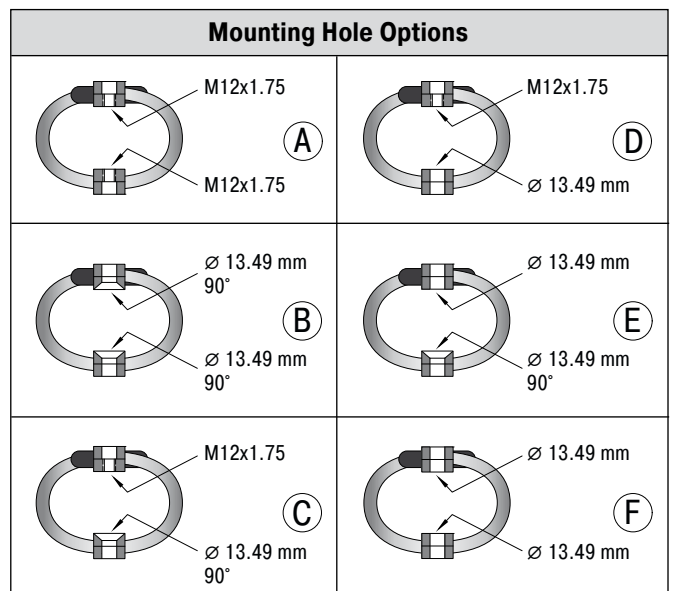

Issue 07.2020 – Specifications subject to change

### Compression

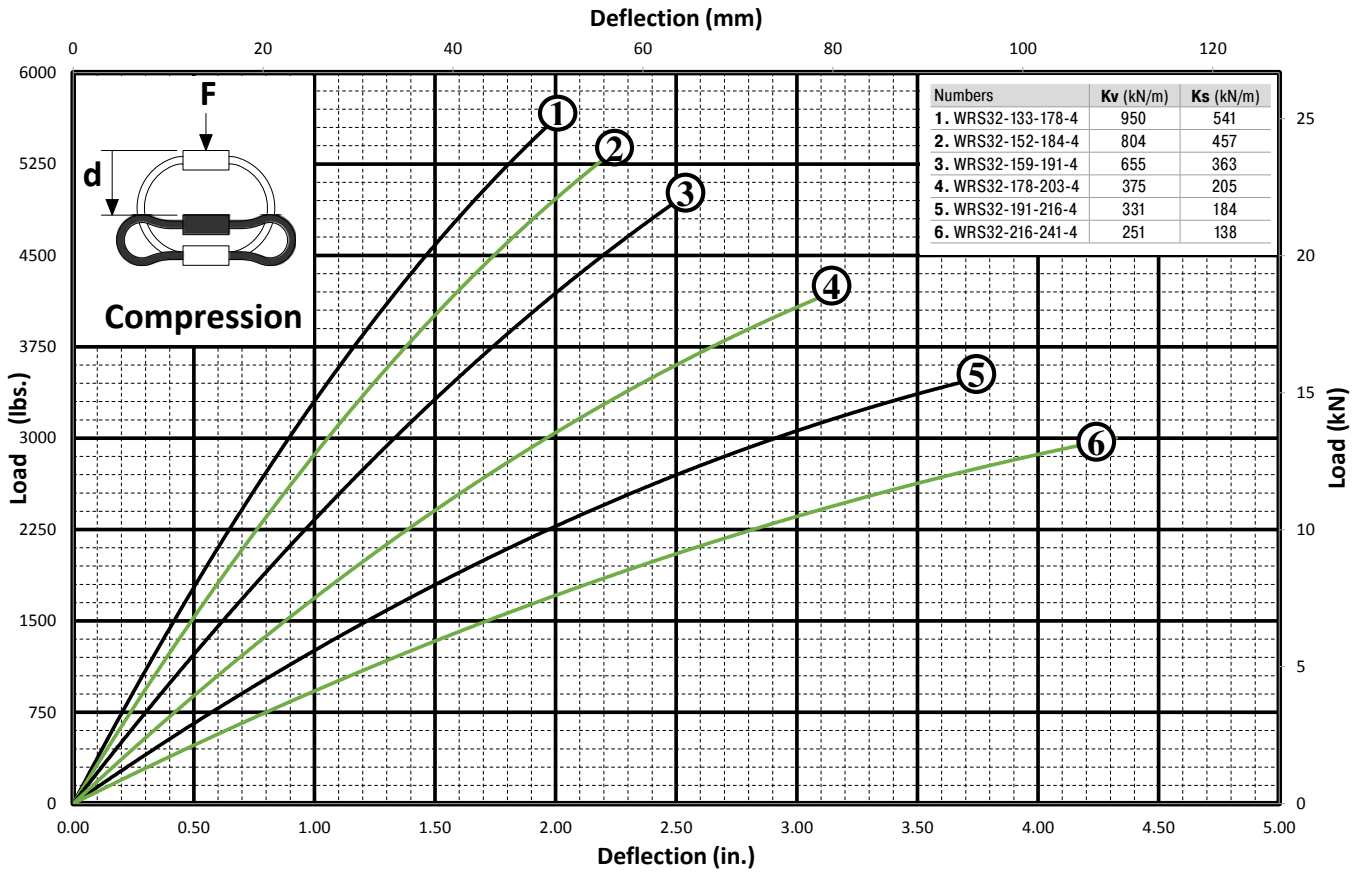

### Tension

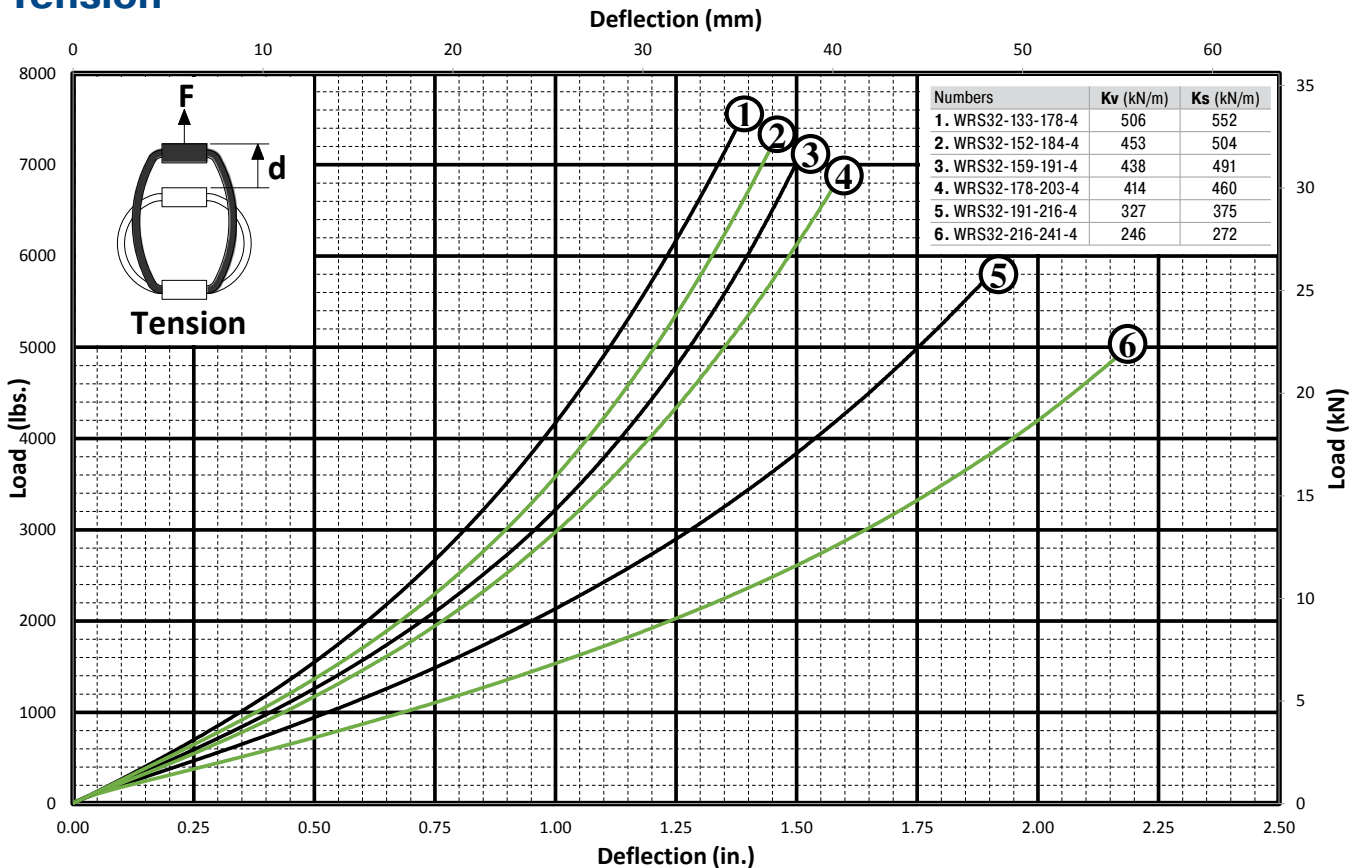

Issue 07.2020 – Specifications subject to change



### Shear

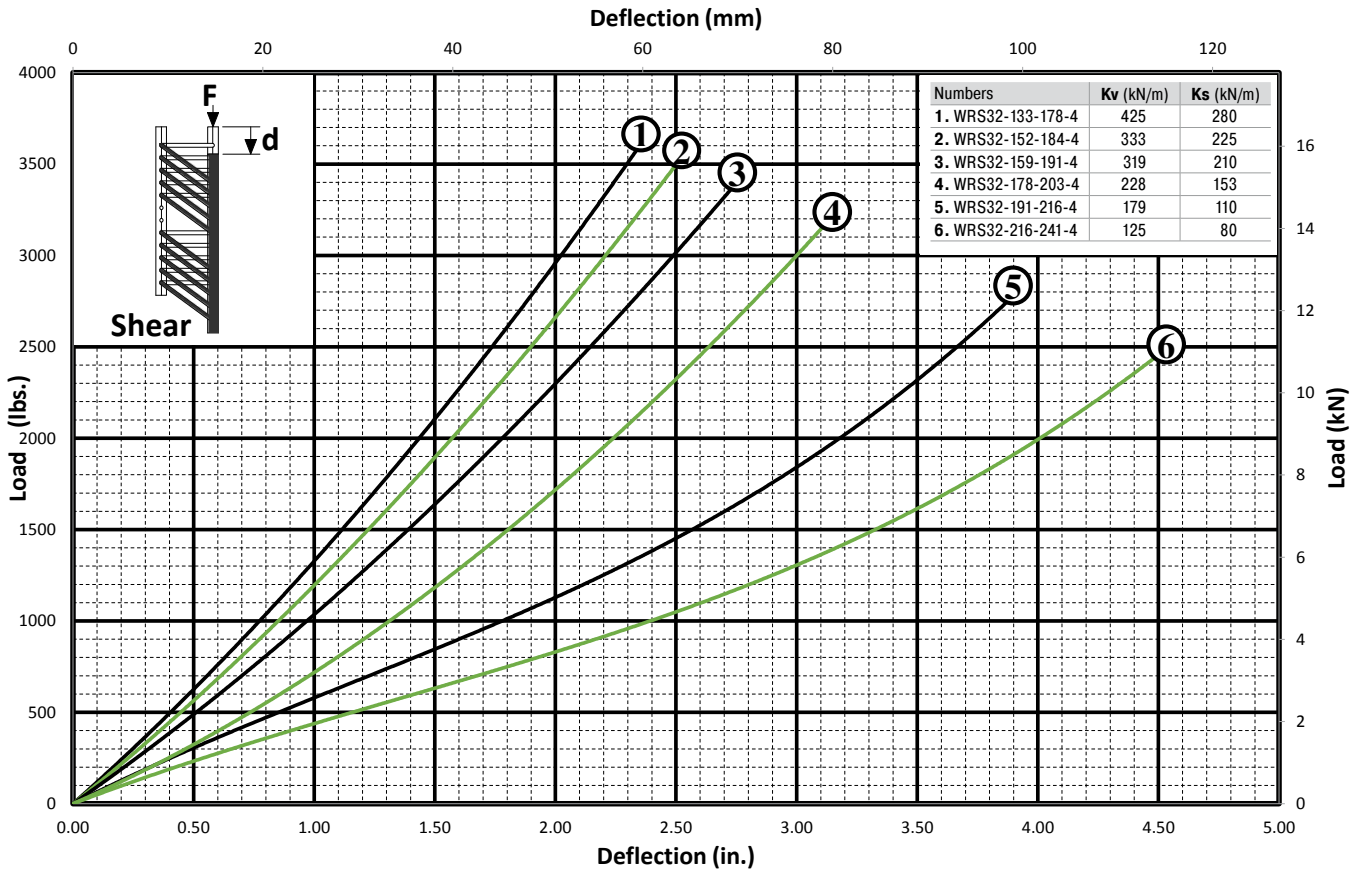

### Roll

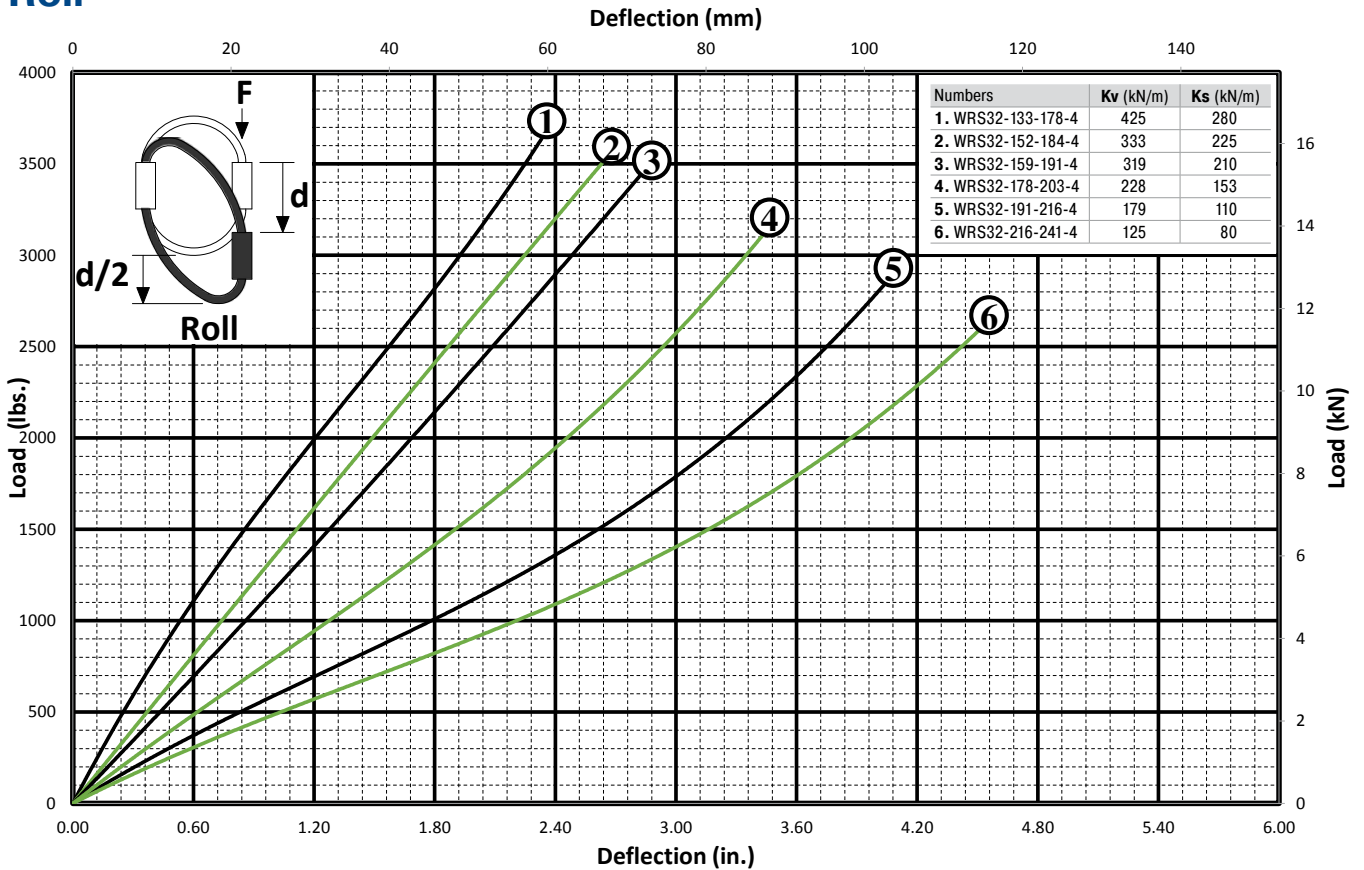

### 45° Compression/Roll

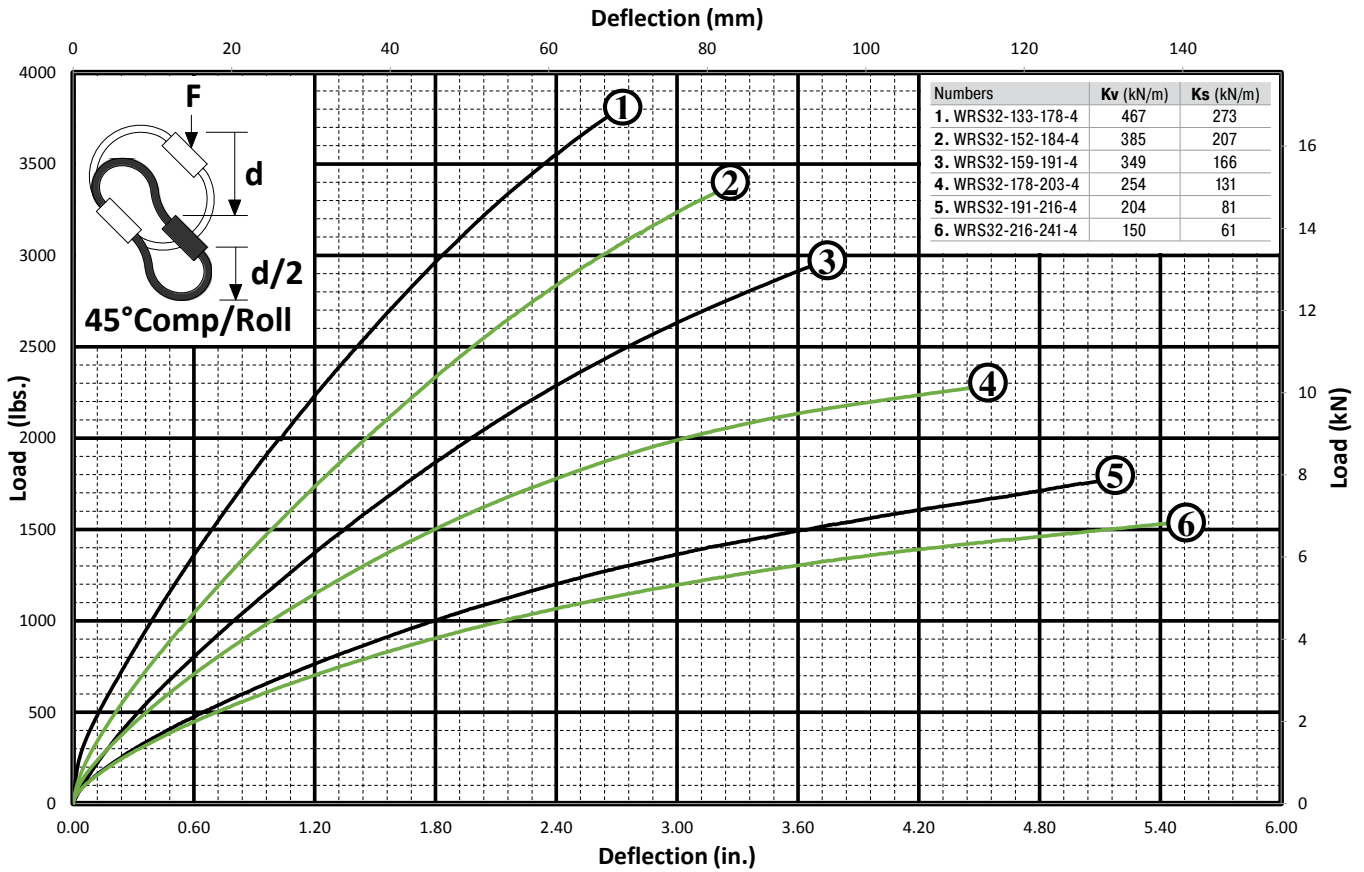

### 45° Tension/Roll

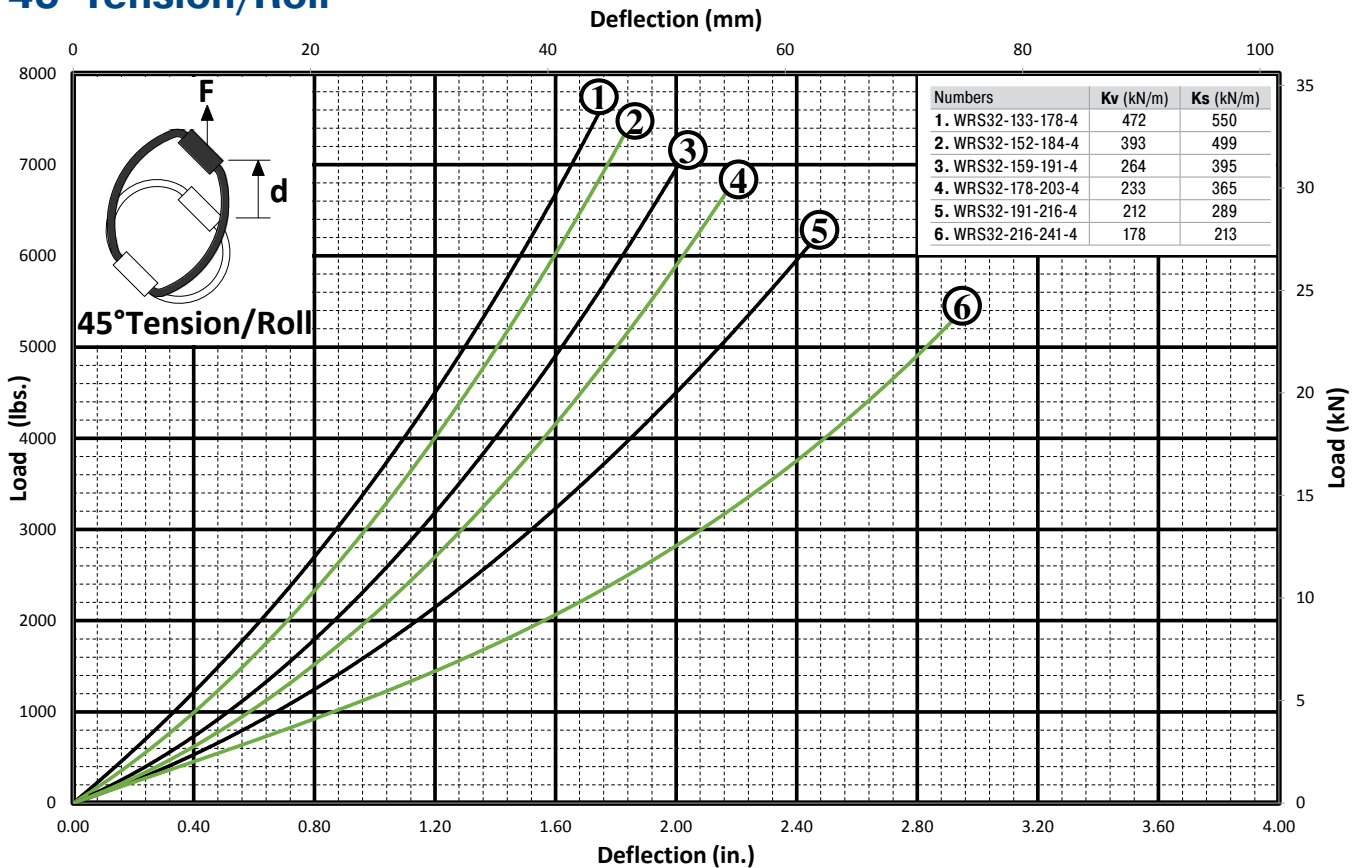

Issue 07.2020 – Specifications subject to change

# CR2

## Square Mount Isolator

**Diameter Cable 1.59 mm (1/16")**



**Features**

- Rugged all metal construction
- Long life and maintenance free
- Three axis capability (6 dof)
- High damping: C/cc ≈ 0.15 to 0.20

**Operating temperature range**

-130°C to +260°C

**Material**

Cable: 300 Series SS per MIL-W-83420 or RR-W-410  
 Inserts: 300 Series SS per MS122076  
 Retainer bars: 6063-T52 Aluminum alloy/chem film IAW MIL-C-5541, Class 1A

**On request**

Special materials, size, mounting holes, finish, etc. available

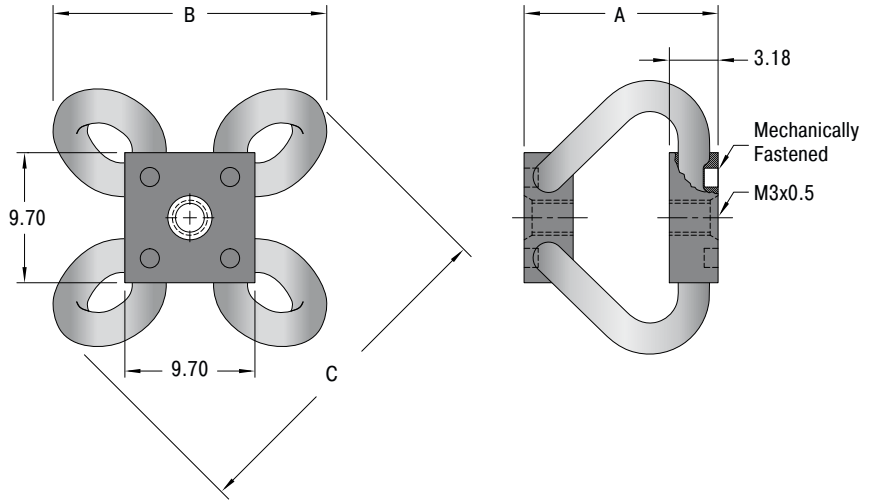

**Performance**

TYPES	A (+/- 0.8) mm	B mm	C mm	M	Compression		Roll		Compression/Roll		Weight kg
					Kv (Vibe) kN/m	Ks (Shock) kN/m	Kv (Vibe) kN/m	Ks (Shock) kN/m	Kv (Vibe) kN/m	Ks (Shock) kN/m	
CR2-011-017	11.2	17.3	22.1	M3x0.5	8.6	9.1	7.2	8.4	4.0	4.0	0.002
CR2-013-019	12.7	19.1	19.1	M3x0.5	4.0	4.2	3.2	3.7	1.9	1.8	0.002
CR2-016-020	15.7	20.3	25.4	M3x0.5	3.0	2.5	1.6	2.8	1.1	0.7	0.003

## Compression

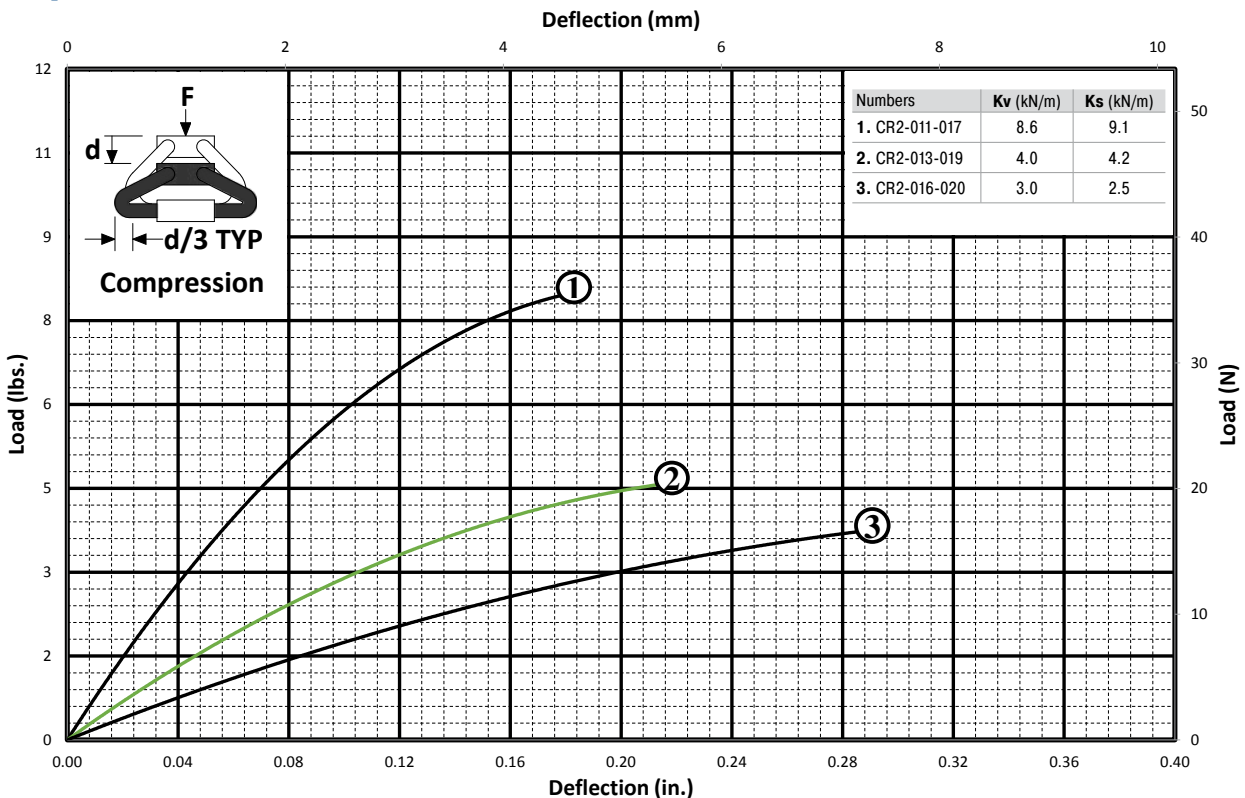

### Roll

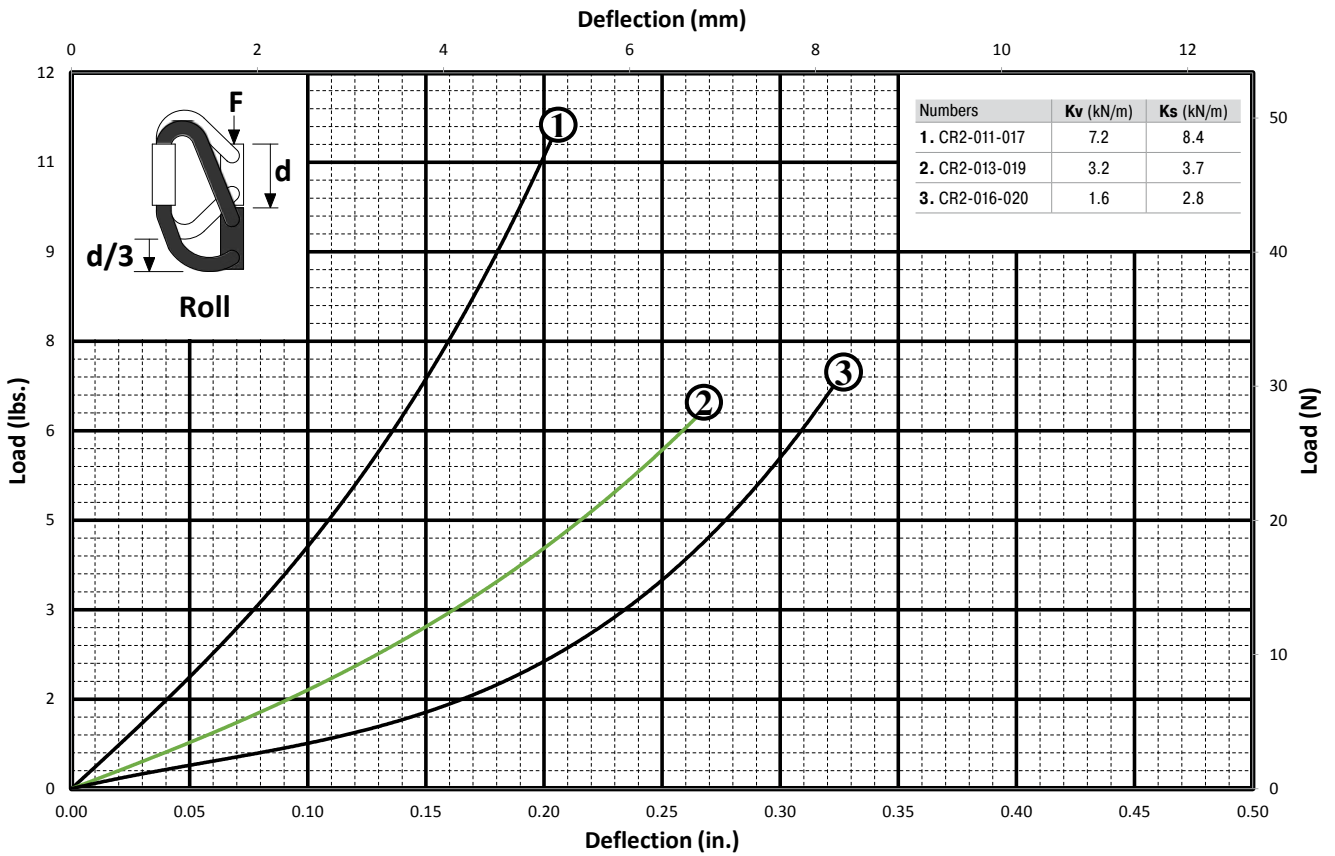

### 45° Compression/Roll

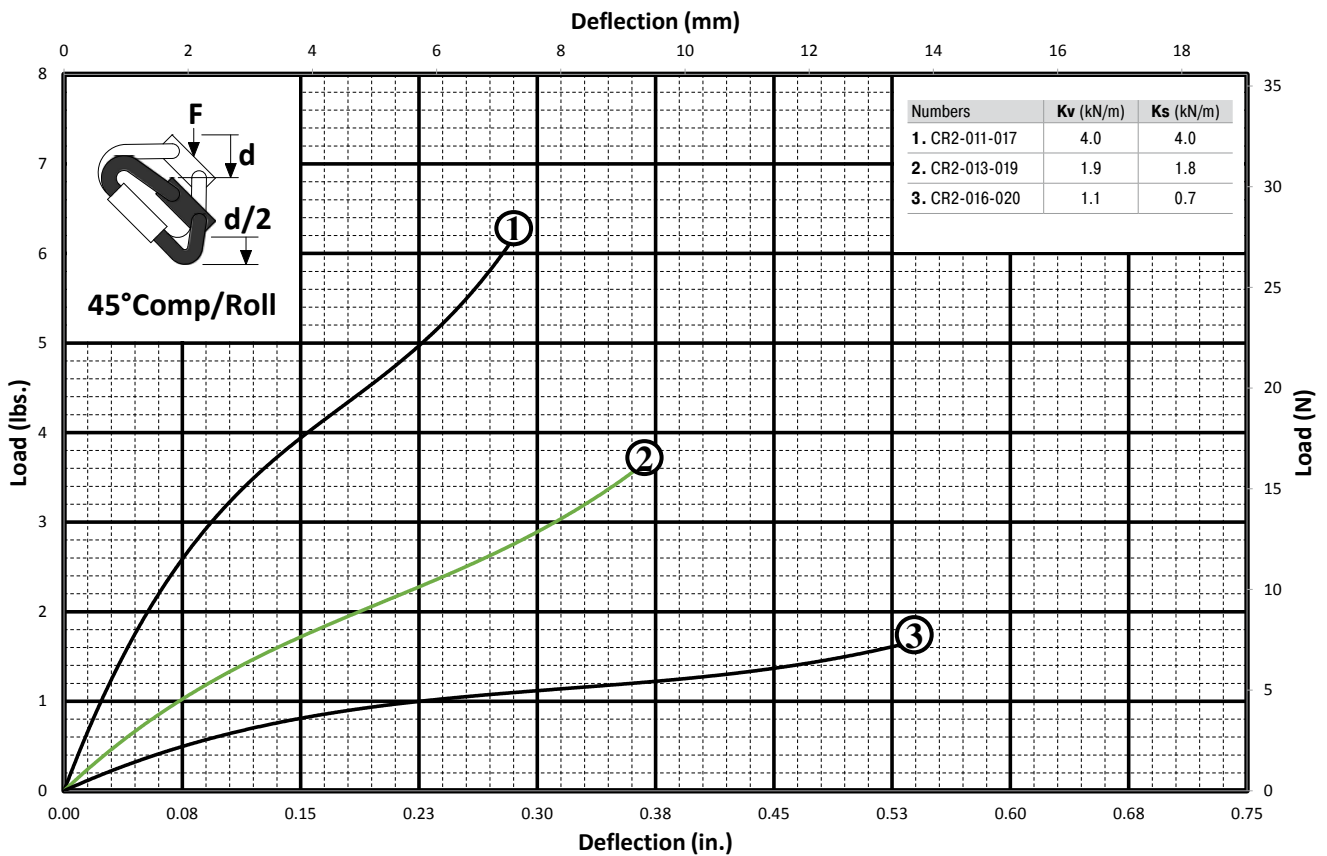

Issue 07.2020 – Specifications subject to change

# CR3

## Square Mount Isolator

2.38 mm (3/32") Diameter Cable



### Features

- Rugged all metal construction
- Long life and maintenance free
- Three axis capability (6 dof)
- High damping:  $C/cc \approx 0.15$  to  $0.20$

### Material

- Cable: 300 Series SS per MIL-W-83420 or RR-W-410
- Inserts: 300 Series SS per MS124655
- Retainer bars: 6063-T52 Aluminum alloy/chem film IAW MIL-C-5541, Class 1A

### On request

Special materials, size, mounting holes, finish, etc. available

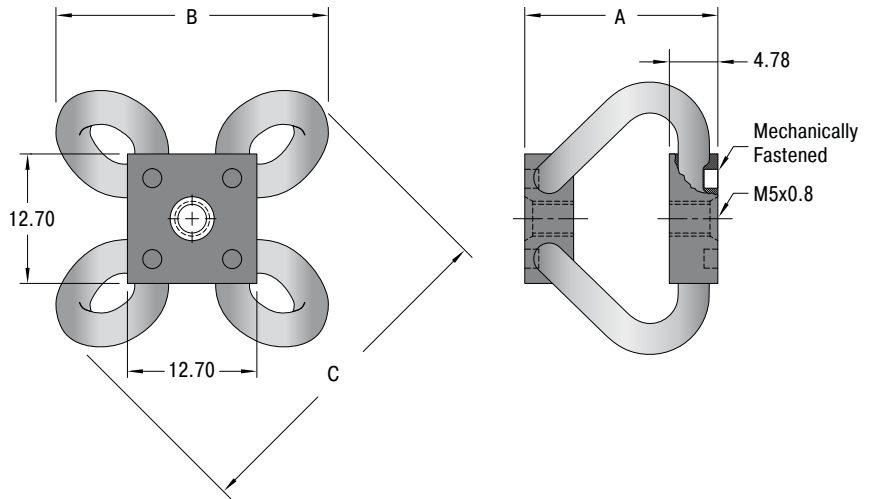

### Performance

TYPES	A (+/- 0.8) mm	B mm	C mm	M	Compression		Roll		Compression/Roll		Weight kg
					Kv (Vibe) kN/m	Ks (Shock) kN/m	Kv (Vibe) kN/m	Ks (Shock) kN/m	Kv (Vibe) kN/m	Ks (Shock) kN/m	
CR3-018-026	17.8	25.9	33.5	M5x0.8	12	10	6.5	7.4	6.8	5.4	0.006
CR3-022-028	21.6	27.9	37.1	M5x0.8	5.6	4.4	2.6	3.3	3.7	2.6	0.007
CR3-025-032	25.4	31.8	40.9	M5x0.8	3.3	2.5	1.4	2.1	2.3	1.4	0.009

## Compression

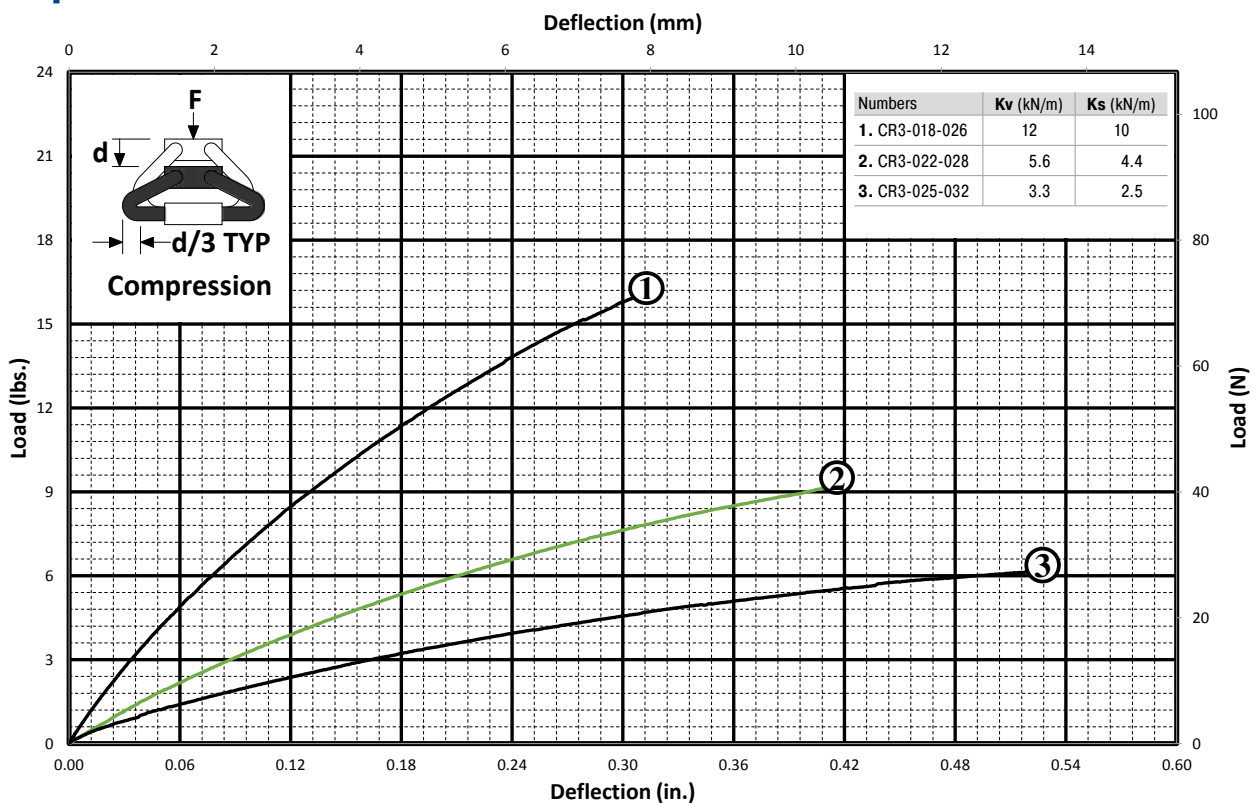



## Roll

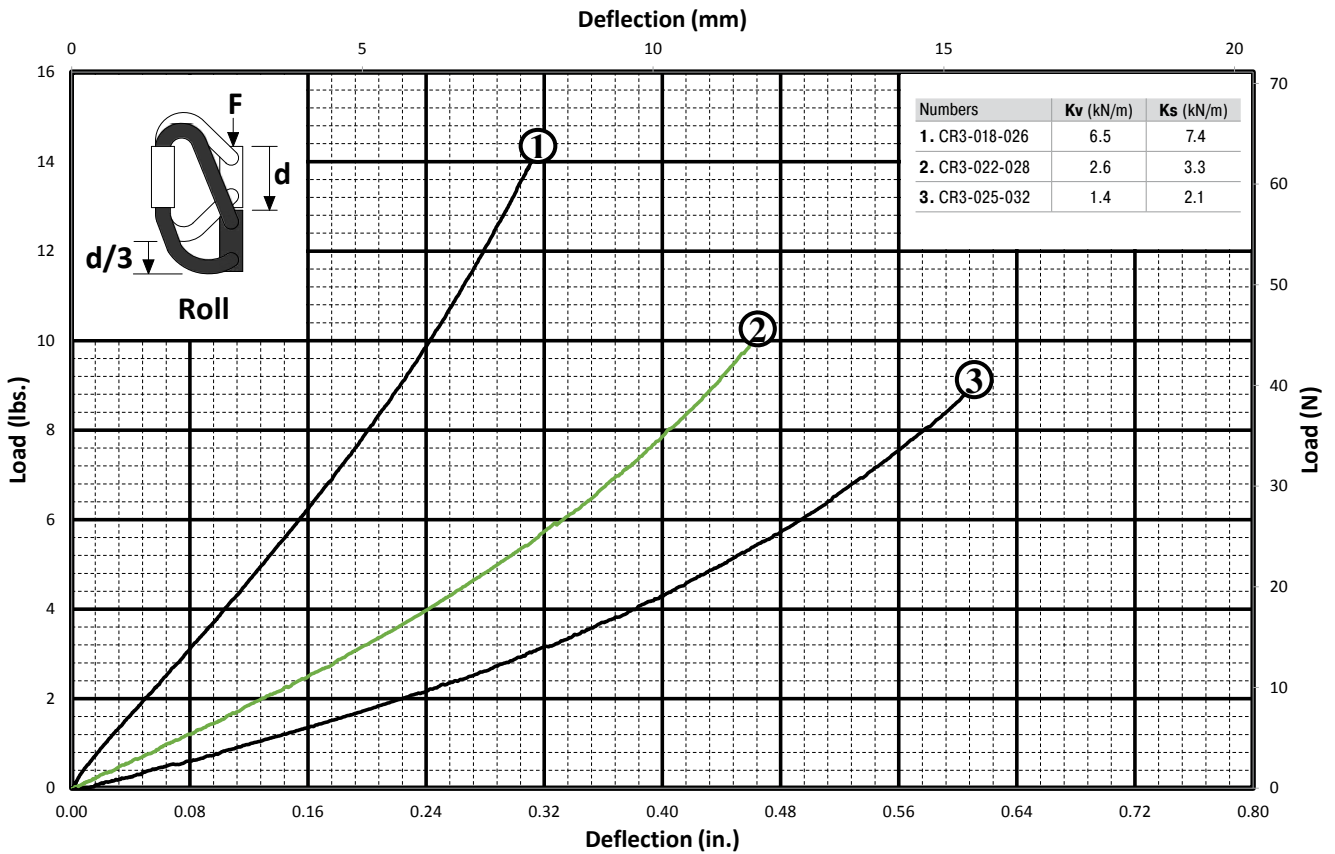

## 45° Compression/Roll

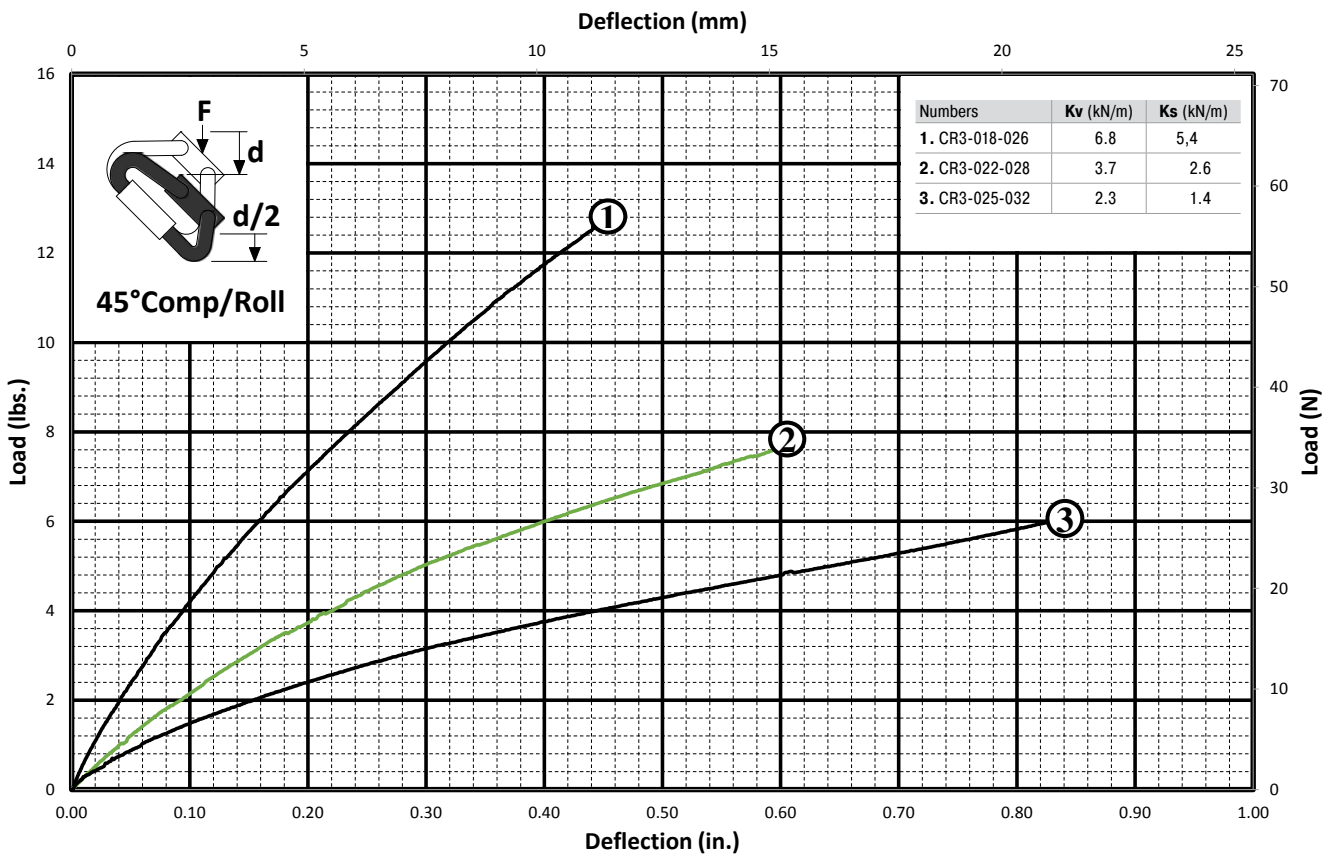

# CR4

## Square Mount Isolator

3.18 mm (1/8") Diameter Cable



### Features

- Rugged all metal construction
- Long life and maintenance free
- Three axis capability (6 dof)
- High damping:  $C/cc \approx 0.15$  to  $0.20$

### Material

- Cable: 300 Series SS per MIL-W-83420 or RR-W-410
- Inserts: 300 Series SS per MS124655
- Retainer bars: 6063-T52 Aluminum alloy/chem film IAW MIL-C-5541, Class 1A

### On request

Special materials, size, mounting holes, finish, etc. available

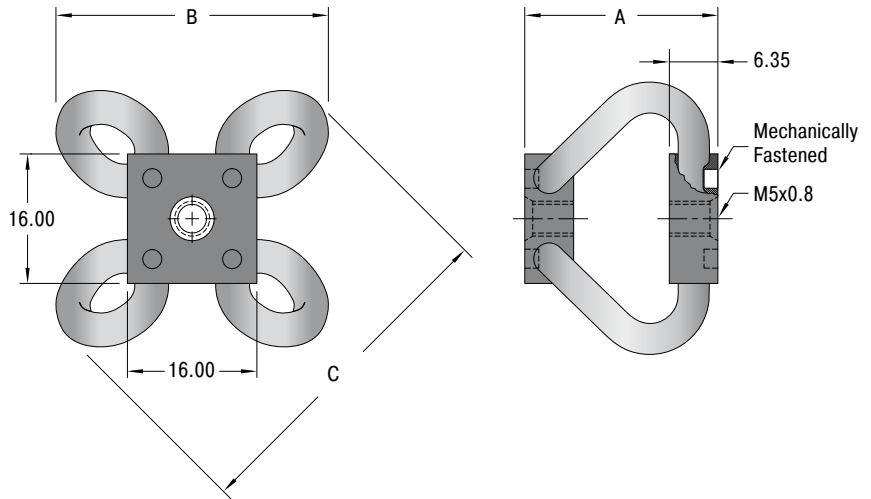

### Performance

TYPES	A (+/- 0.8) mm	B mm	C mm	M	Compression		Roll		Compression/Roll		Weight kg
					Kv (Vibe) kN/m	Ks (Shock) kN/m	Kv (Vibe) kN/m	Ks (Shock) kN/m	Kv (Vibe) kN/m	Ks (Shock) kN/m	
CR4-023-032	22.9	32.0	41.1	M5x0.8	21	17	11	13	15	11	0.014
CR4-025-036	25.4	36.3	47.0	M5x0.8	11	8.2	5.1	5.6	8.1	6.3	0.015
CR4-028-038	27.9	38.4	50.0	M5x0.8	7.0	5.8	3.3	4.2	5.1	3.5	0.017

## Compression

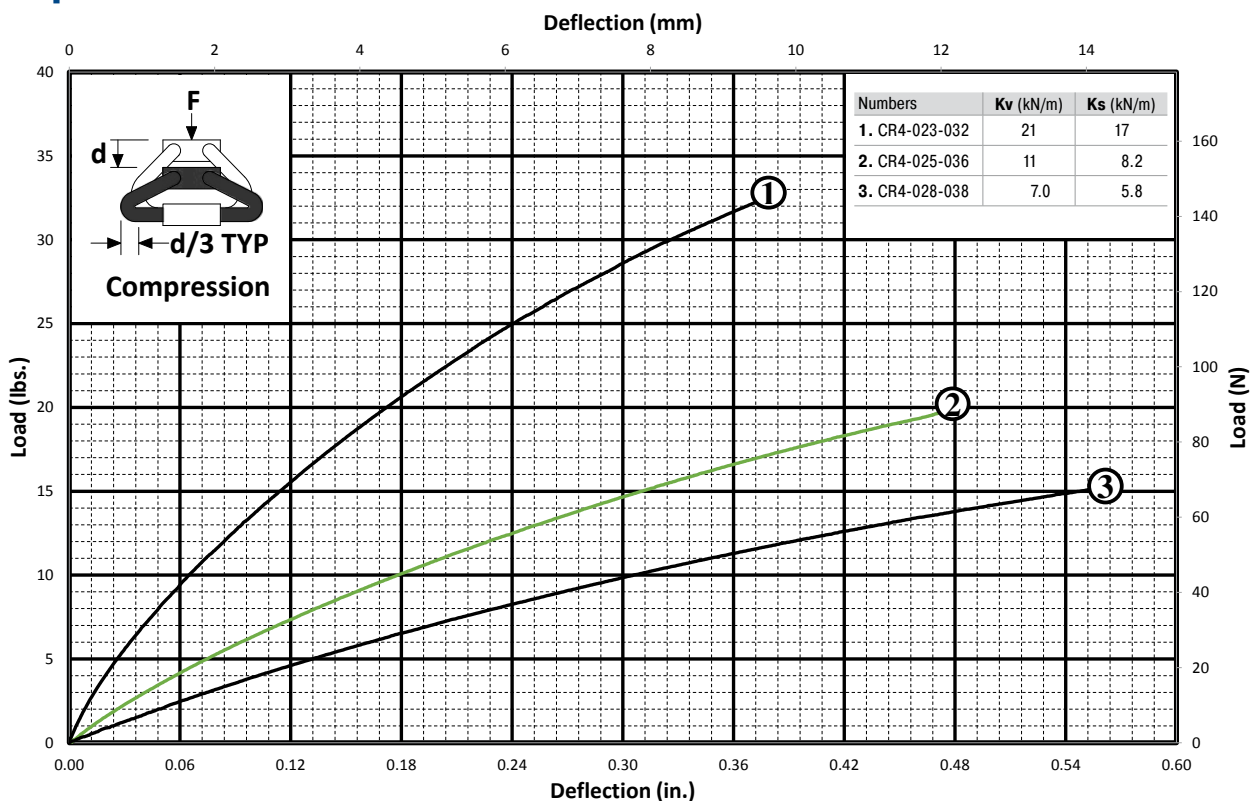

## Roll

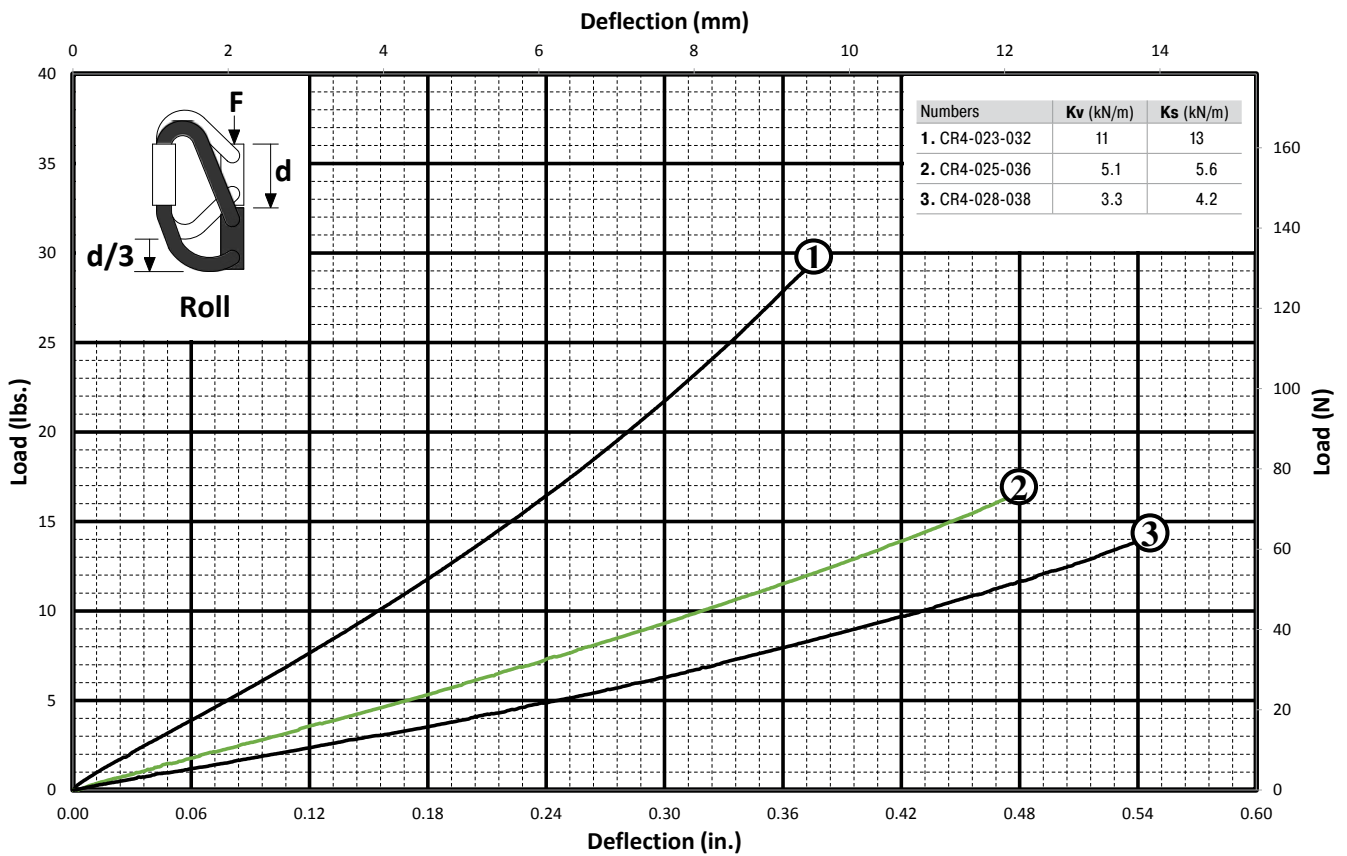

## 45° Compression/Roll

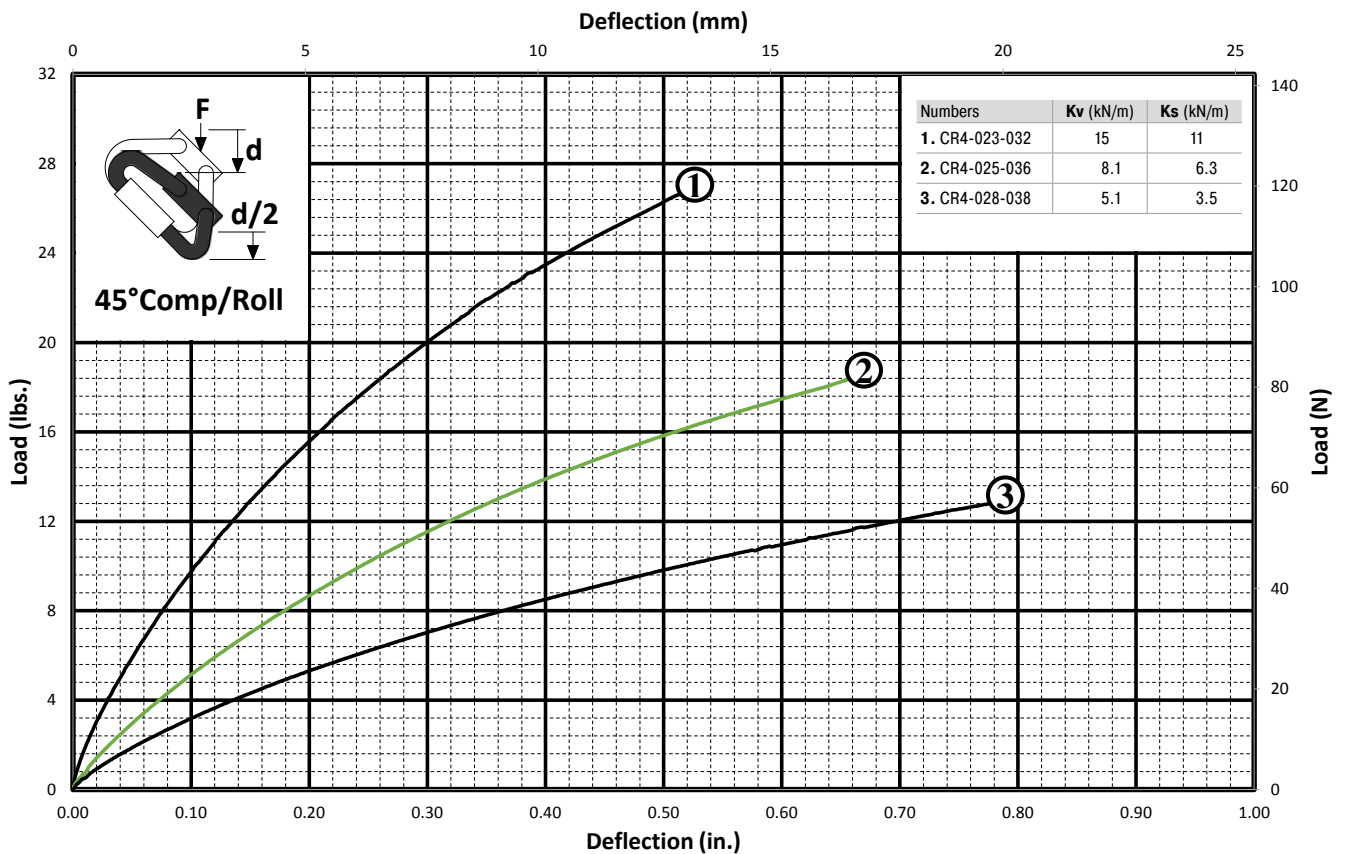

# CR5

## Square Mount Isolator

3.97 mm (5/32") Diameter Cable



### Features

- Rugged all metal construction
- Long life and maintenance free
- Three axis capability (6 dof)
- High damping:  $C/cc \approx 0.15$  to  $0.20$

### Material

- Cable: 300 Series SS per MIL-W-83420 or RR-W-410
- Inserts: 300 Series SS per MS124655
- Retainer bars: 6063-T52 Aluminum alloy/chem film IAW MIL-C-5541, Class 1A

### On request

Special materials, size, mounting holes, finish, etc. available

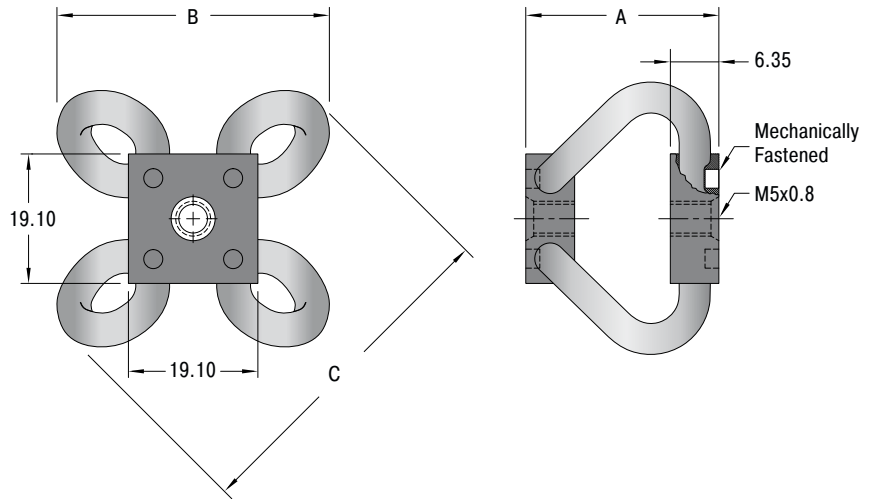

### Performance

TYPES	A (+/- 0.8) mm	B mm	C mm	M	Compression		Roll		Compression/Roll		Weight kg
					Kv (Vibe) kN/m	Ks (Shock) kN/m	Kv (Vibe) kN/m	Ks (Shock) kN/m	Kv (Vibe) kN/m	Ks (Shock) kN/m	
CR5-025-043	25.4	43.4	56.9	M5x0.8	17	13	9.5	10	11	8.8	0.023
CR5-031-048	30.5	48.3	63.5	M5x0.8	11	8.1	5.4	6.0	7.9	5.4	0.028
CR5-037-053	36.8	53.3	69.3	M5x0.8	7.0	4	3.5	3.5	4.9	3.2	0.031

## Compression

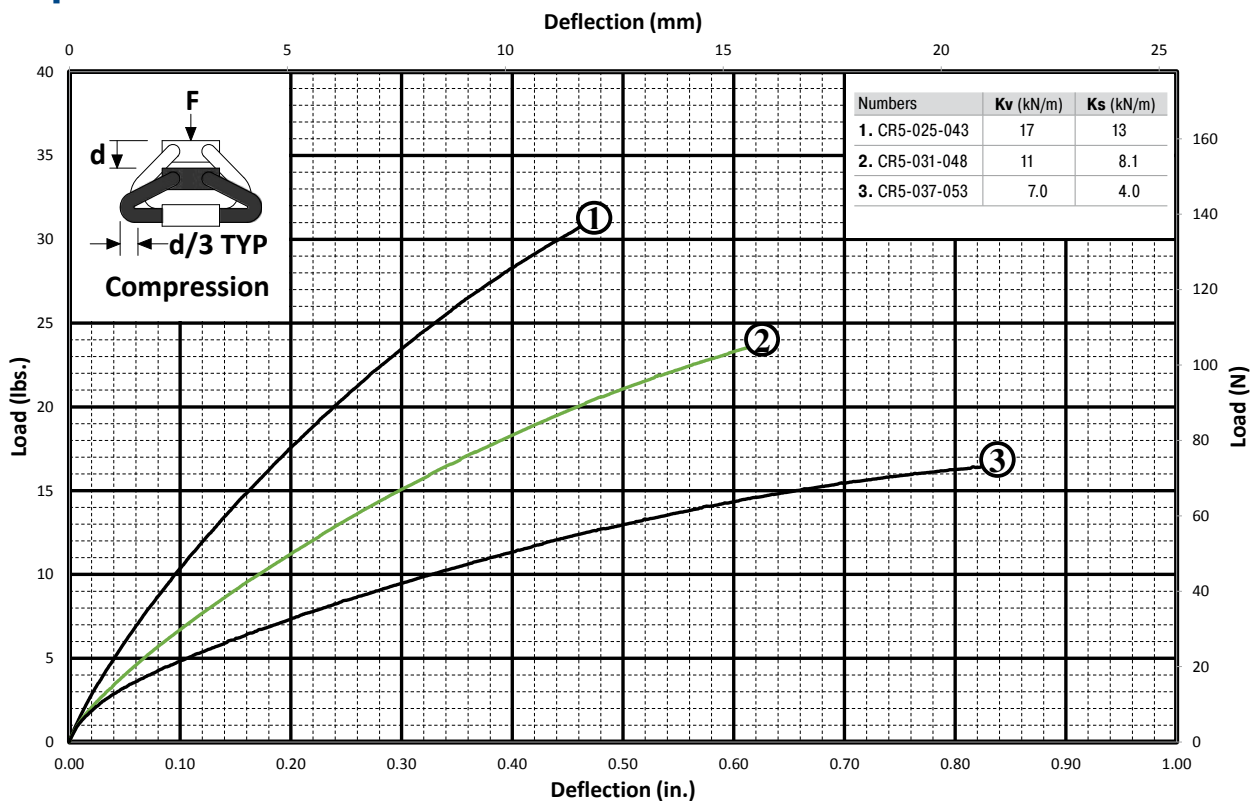

### Roll

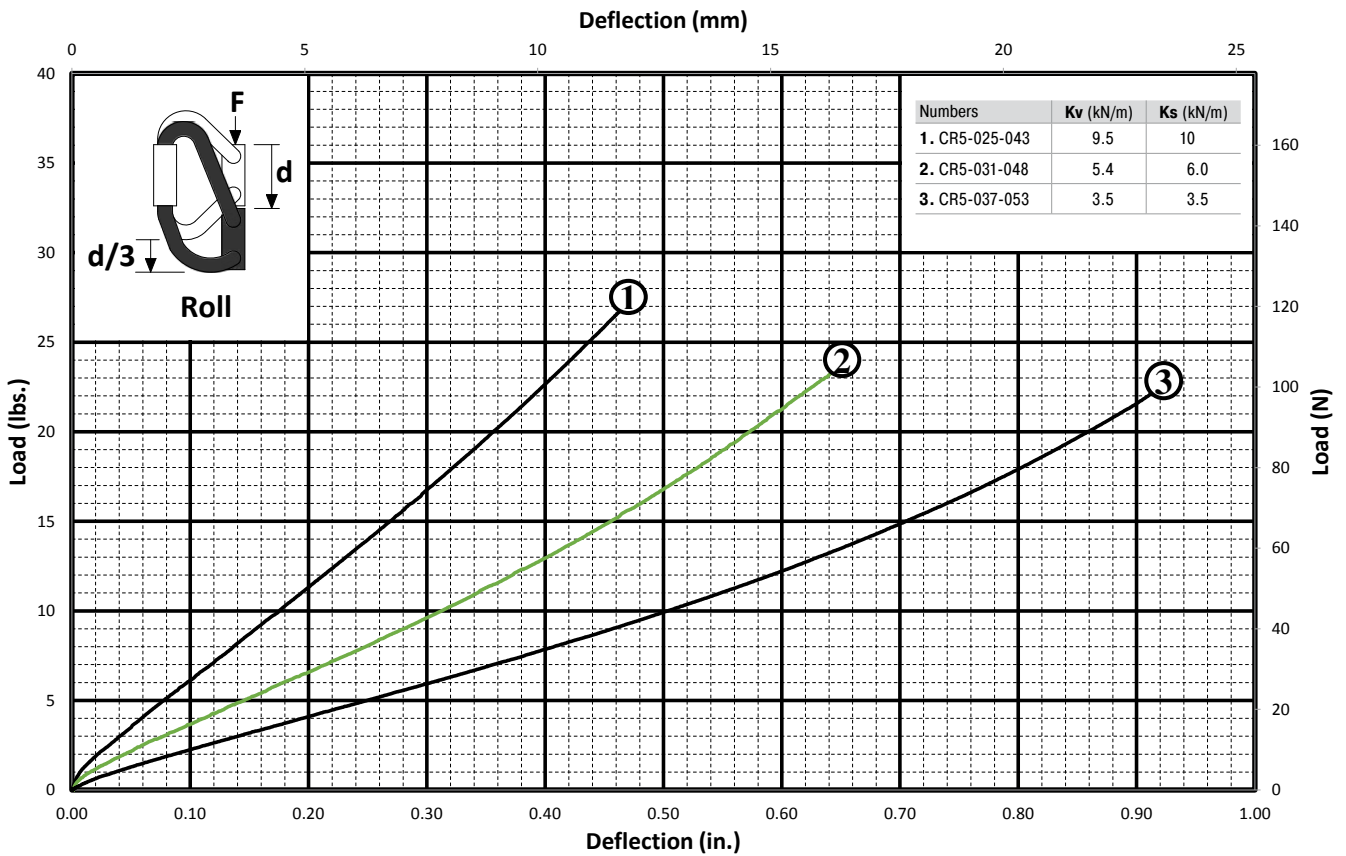

### 45° Compression/Roll

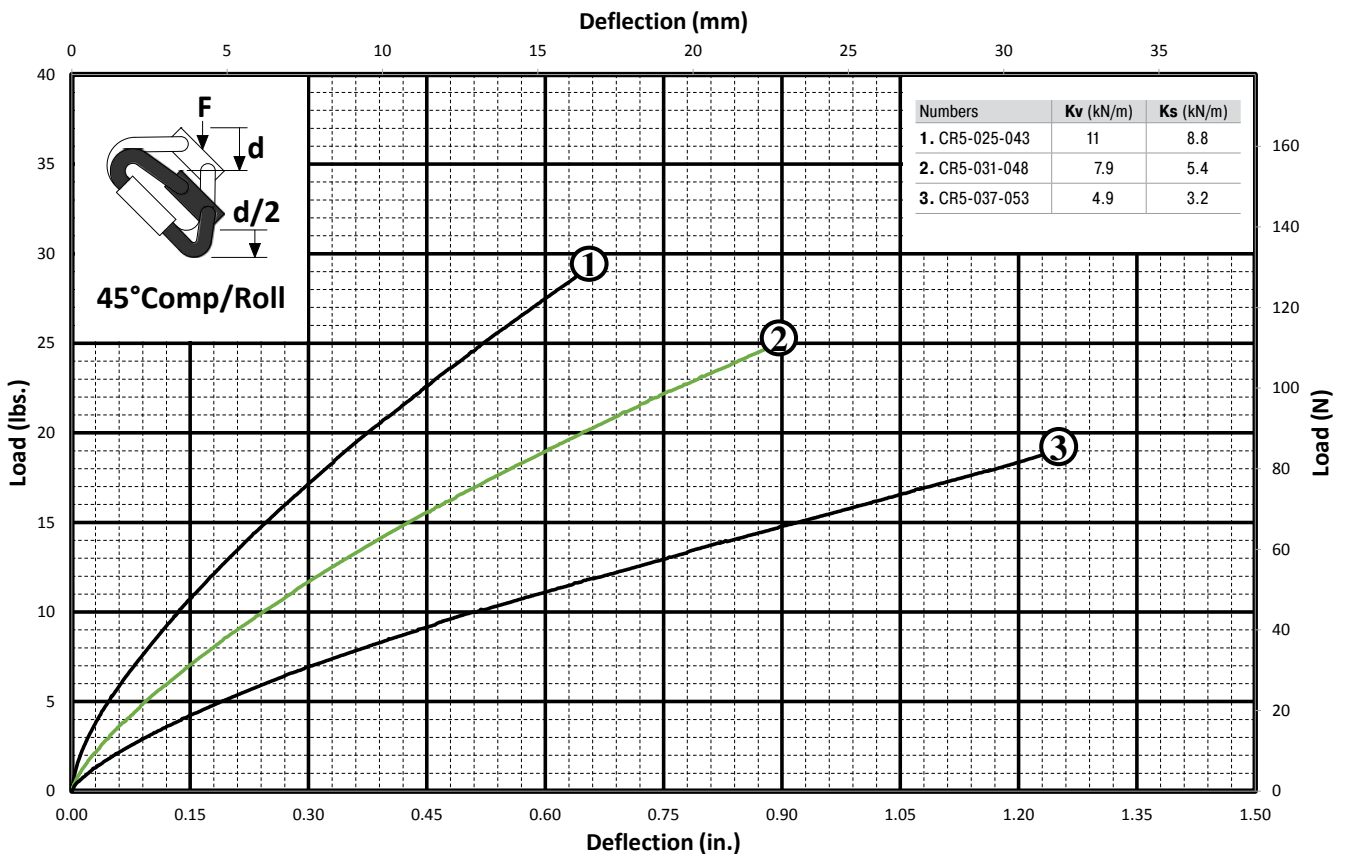

Issue 07.2020 – Specifications subject to change



# CR6

## Square Mount Isolator

4.76 mm (3/16") Diameter Cable



### Features

- Rugged all metal construction
- Long life and maintenance free
- Three axis capability (6 dof)
- High damping:  $C/cc \approx 0.15$  to  $0.20$

### Material

- Cable: 300 Series SS per MIL-W-83420 or RR-W-410
- Inserts: 300 Series SS per MS122081
- Retainer bars: 6063-T52 Aluminum alloy/chem film IAW MIL-C-5541, Class 1A

### On request

Special materials, size, mounting holes, finish, etc. available

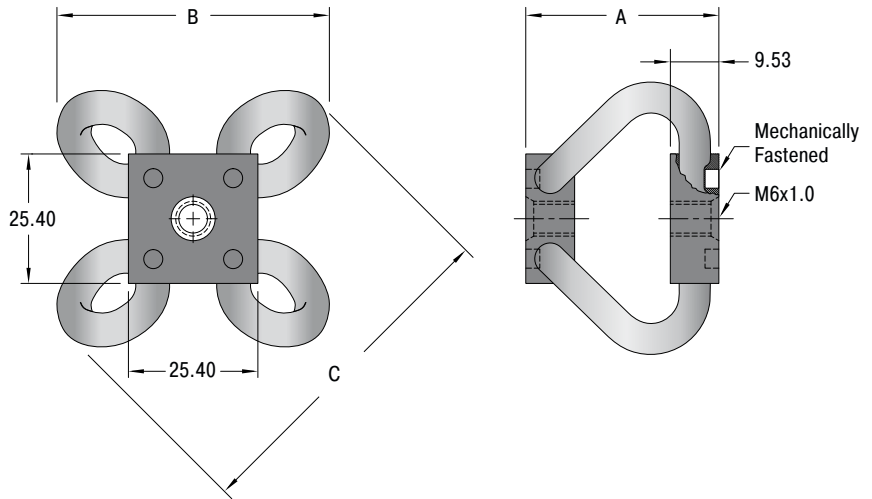

### Performance

TYPES	A (+/- 0.8) mm	B mm	C mm	M	Compression		Roll		Compression/Roll		Weight kg
					Kv (Vibe) kN/m	Ks (Shock) kN/m	Kv (Vibe) kN/m	Ks (Shock) kN/m	Kv (Vibe) kN/m	Ks (Shock) kN/m	
CR6-042-057	41.9	57.2	75.7	M6x1.0	13	9.1	6.0	6.8	8.4	5.6	0.057
CR6-047-065	47.0	64.8	82.6	M6x1.0	7.4	5.4	3.7	4.2	5.6	3.3	0.062
CR6-055-070	54.6	70.1	91.4	M6x1.0	4.6	2.8	2.3	2.5	3.5	1.8	0.065

## Compression

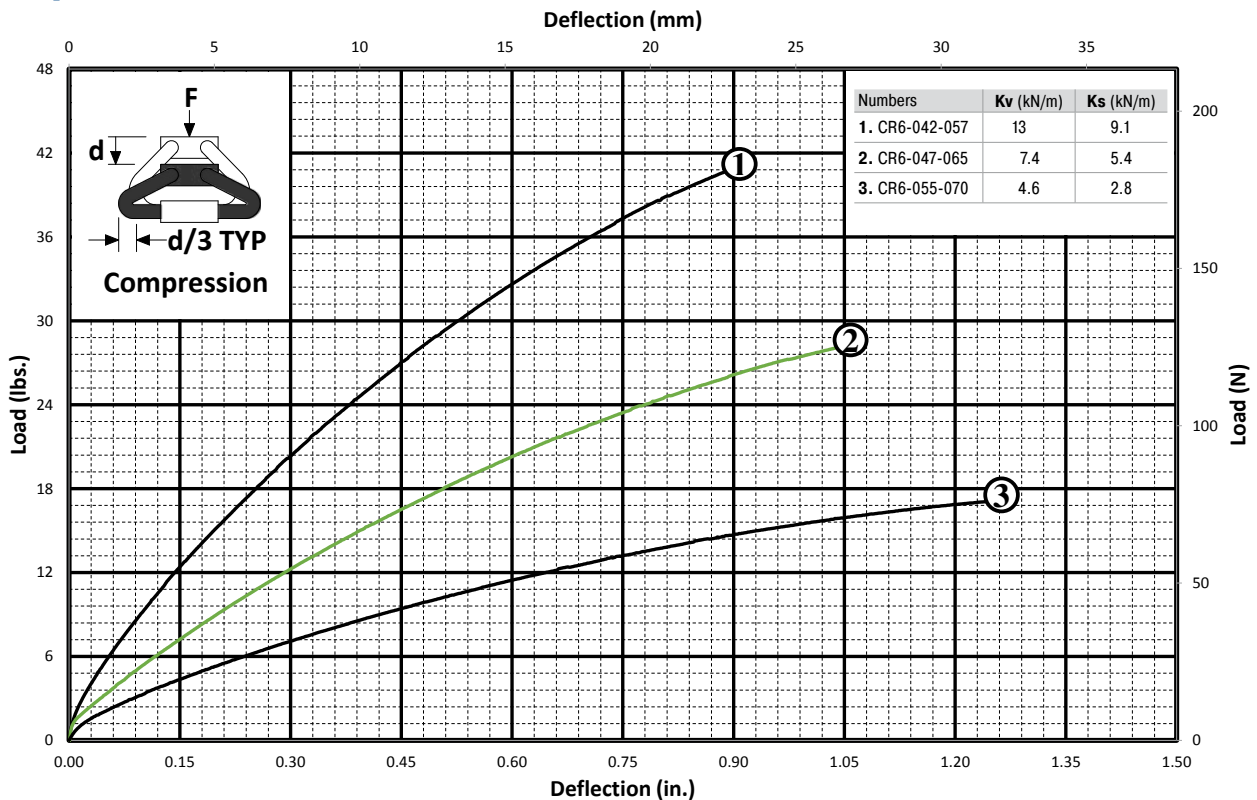

### Roll

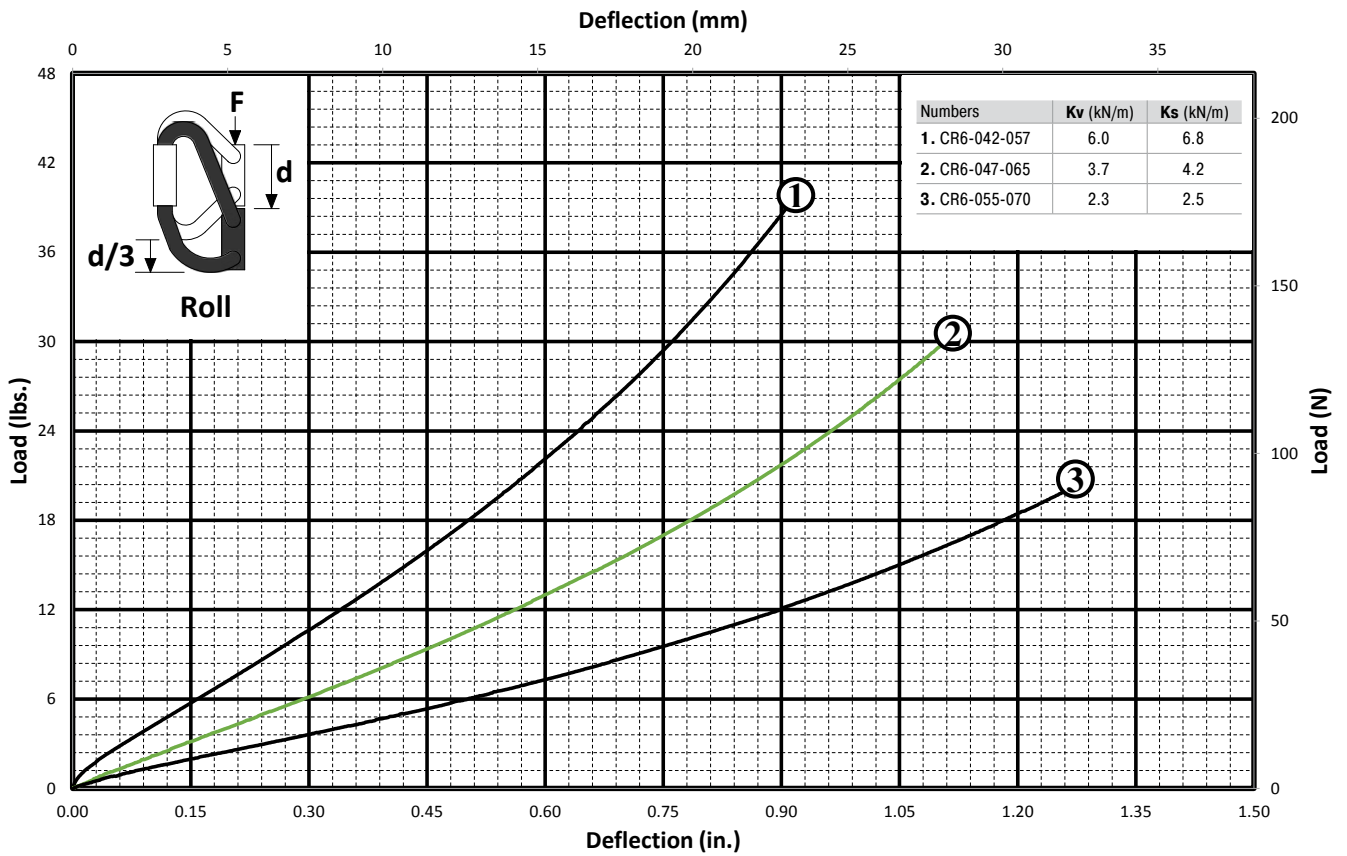

### 45° Compression/Roll

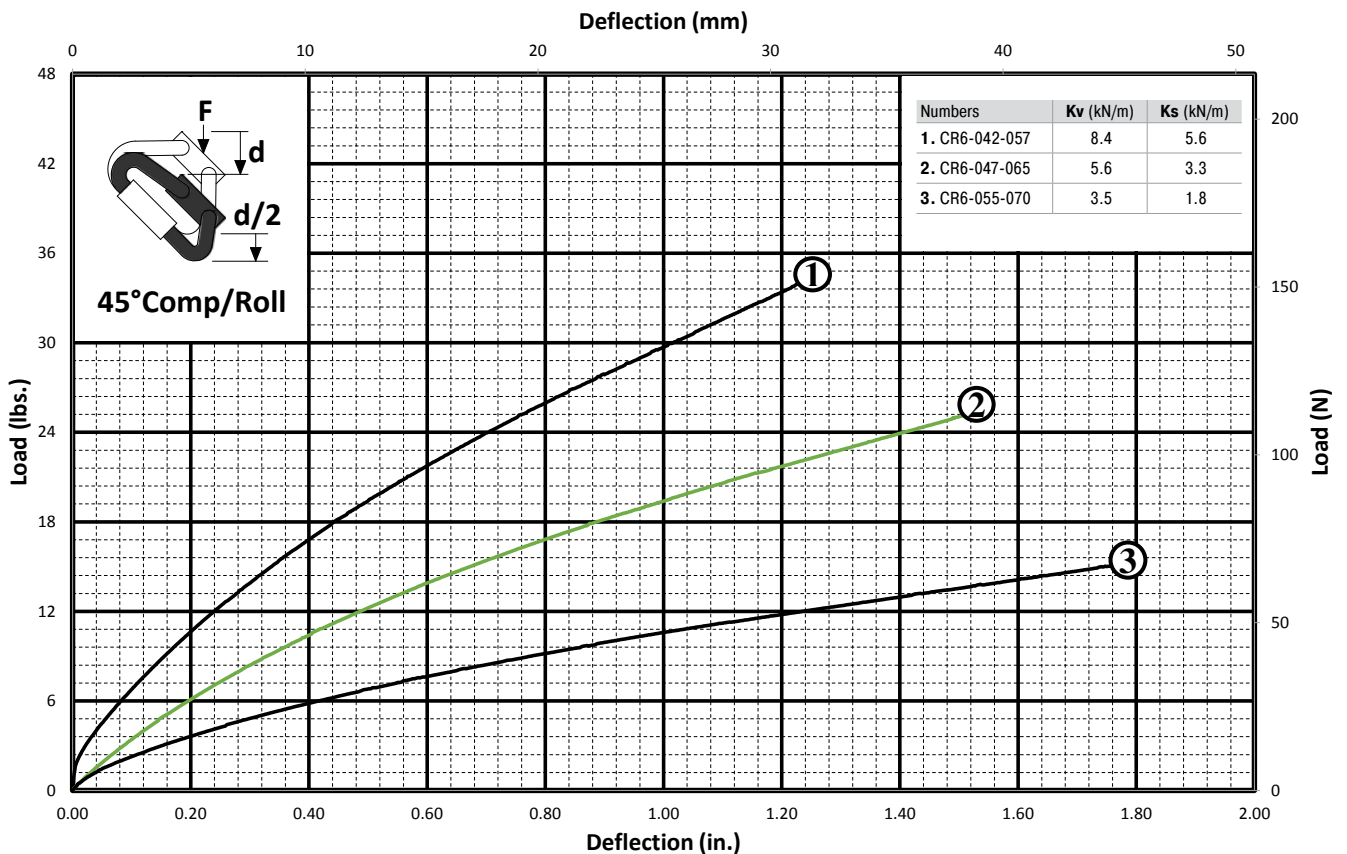

Issue 07.2020 – Specifications subject to change

# CR7

## Square Mount Isolator

5.56 mm (7/32") Diameter Cable



### Features

- Rugged all metal construction
- Long life and maintenance free
- Three axis capability (6 dof)
- High damping:  $C/cc \approx 0.15$  to  $0.20$

### Material

- Cable: 300 Series SS per MIL-W-83420 or RR-W-410
- Inserts: 300 Series SS per MS122081
- Retainer bars: 6063-T52 Aluminum alloy/chem film IAW MIL-C-5541, Class 1A

### On request

Special materials, size, mounting holes, finish, etc. available

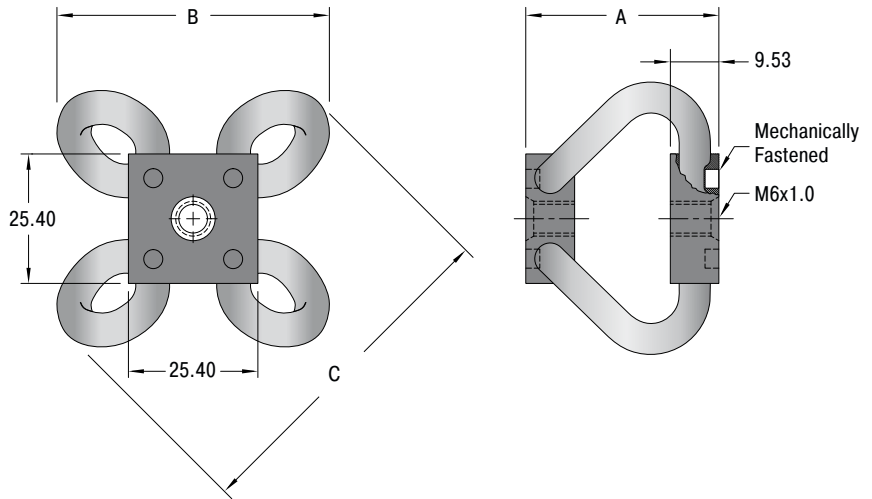

### Performance

TYPES	A (+/- 0.8) mm	B mm	C mm	M	Compression		Roll		Compression/Roll		Weight kg
					Kv (Vibe) kN/m	Ks (Shock) kN/m	Kv (Vibe) kN/m	Ks (Shock) kN/m	Kv (Vibe) kN/m	Ks (Shock) kN/m	
CR7-042-057	41.9	57.2	75.7	M6x1.0	27	14	11	13	18	9.6	0.065
CR7-047-065	47.0	64.8	83.8	M6x1.0	14	7.9	5.6	7.5	8.9	5.3	0.074
CR7-055-071	54.6	71.1	91.4	M6x1.0	8.4	5.3	3.9	5.1	6.0	3.2	0.091

## Compression

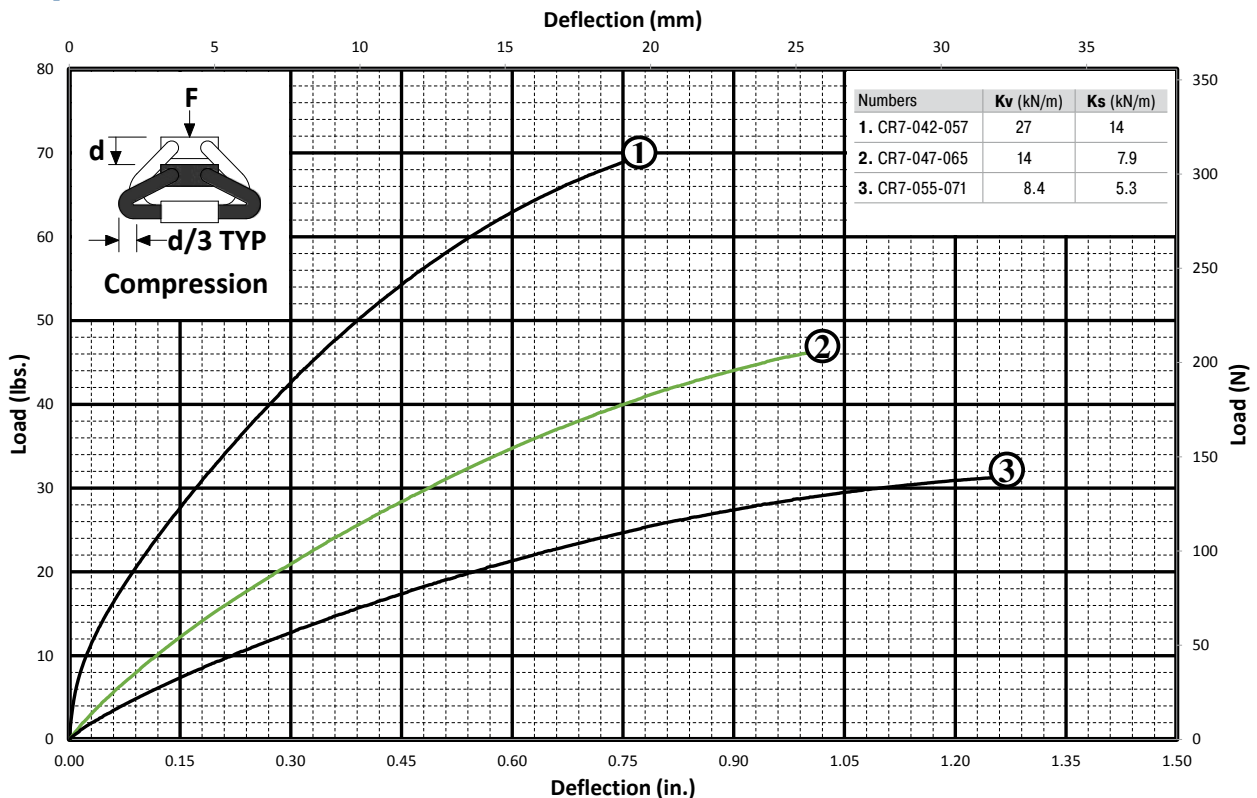

## Roll

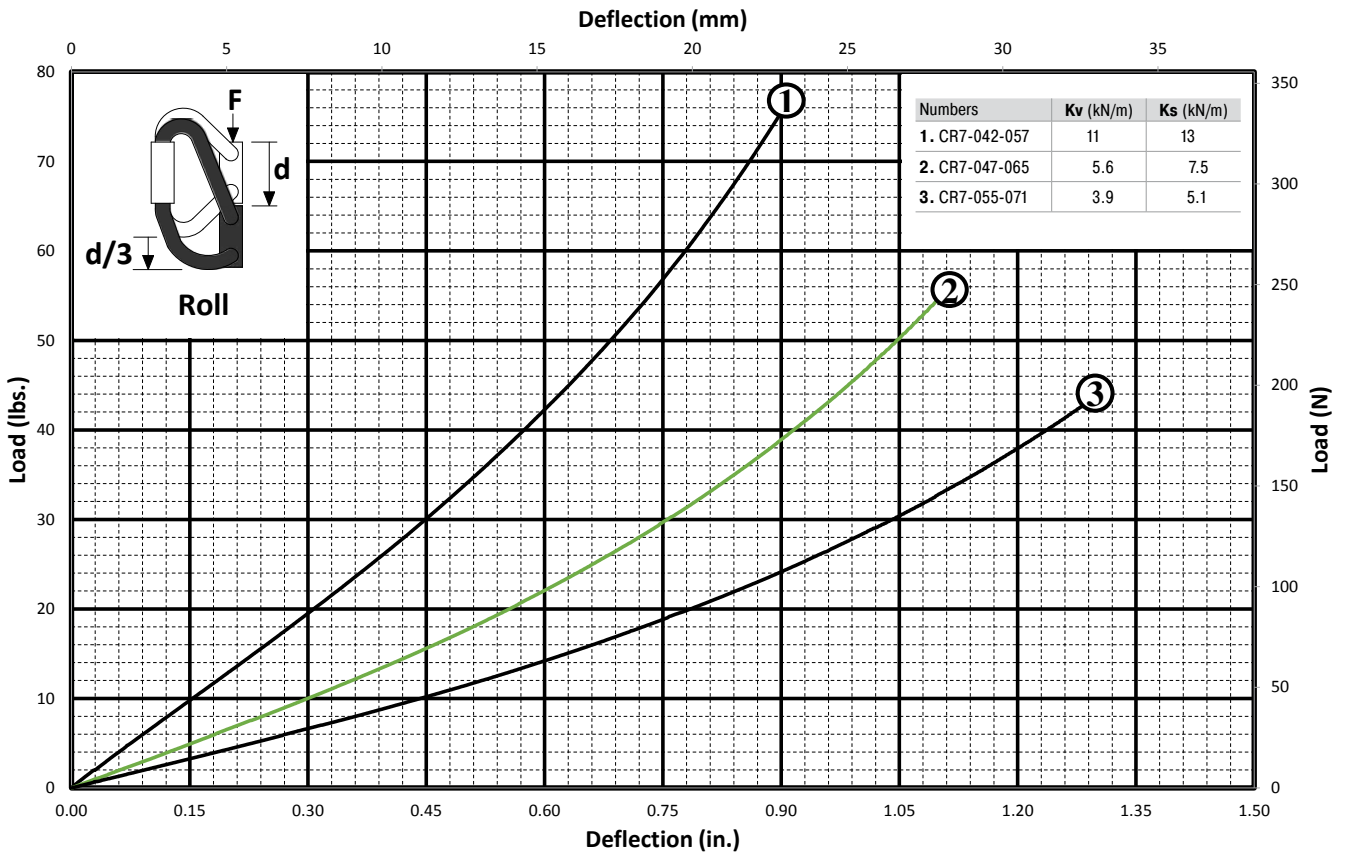

## 45° Compression/Roll

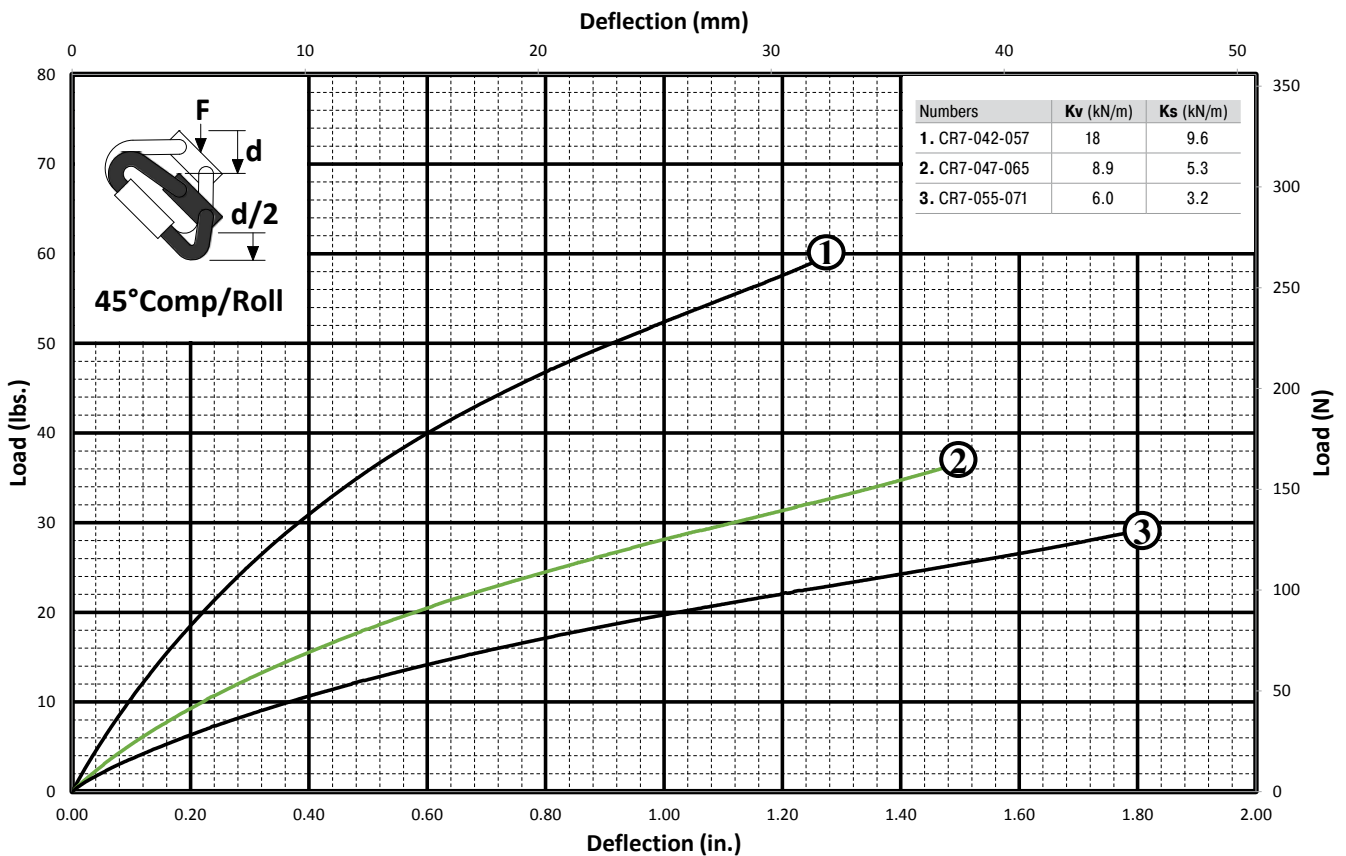

Issue 07.2020 – Specifications subject to change

# CR8

## Square Mount Isolator

### 6.35 mm (1/4") Diameter Cable



#### Features

- Rugged all metal construction
- Long life and maintenance free
- Three axis capability (6 dof)
- High damping:  $C/cc \approx 0.15$  to  $0.20$

#### Material

- Cable: 300 Series SS per MIL-W-83420 or RR-W-410
- Inserts: 300 Series SS per MS122082
- Retainer bars: 6063-T52 Aluminum alloy/chem film IAW MIL-C-5541, Class 1A

#### On request

Special materials, size, mounting holes, finish, etc. available

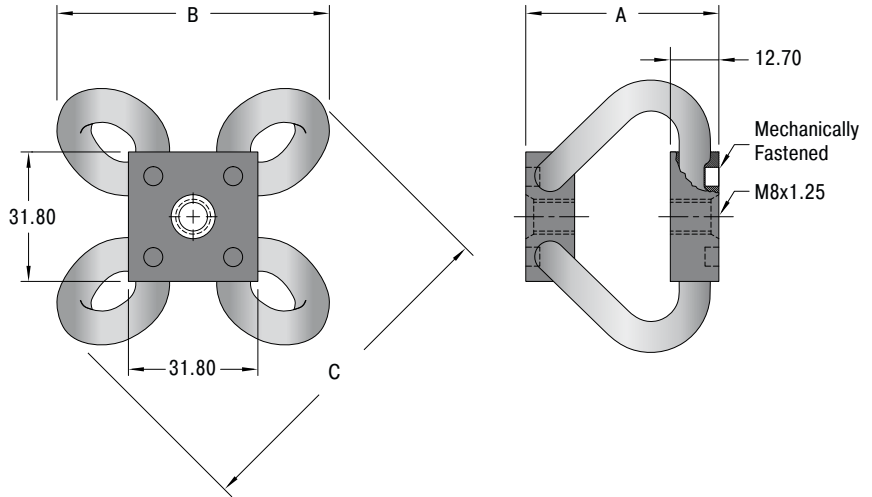

#### Performance

TYPES	A (+/- 0.8) mm	B mm	C mm	M	Compression		Roll		Compression/Roll		Weight kg
					Kv (Vibe) kN/m	Ks (Shock) kN/m	Kv (Vibe) kN/m	Ks (Shock) kN/m	Kv (Vibe) kN/m	Ks (Shock) kN/m	
CR8-051-071	50.8	71.1	92.7	M8x1.25	21	15	12	13	15	9.1	0.122
CR8-057-078	57.2	77.5	99.1	M8x1.25	12	7.5	6.0	7.4	8.4	4.9	0.125
CR8-064-084	63.5	83.8	108.0	M8x1.25	7.9	6.7	3.9	4.9	6.0	3.2	0.136

## Compression

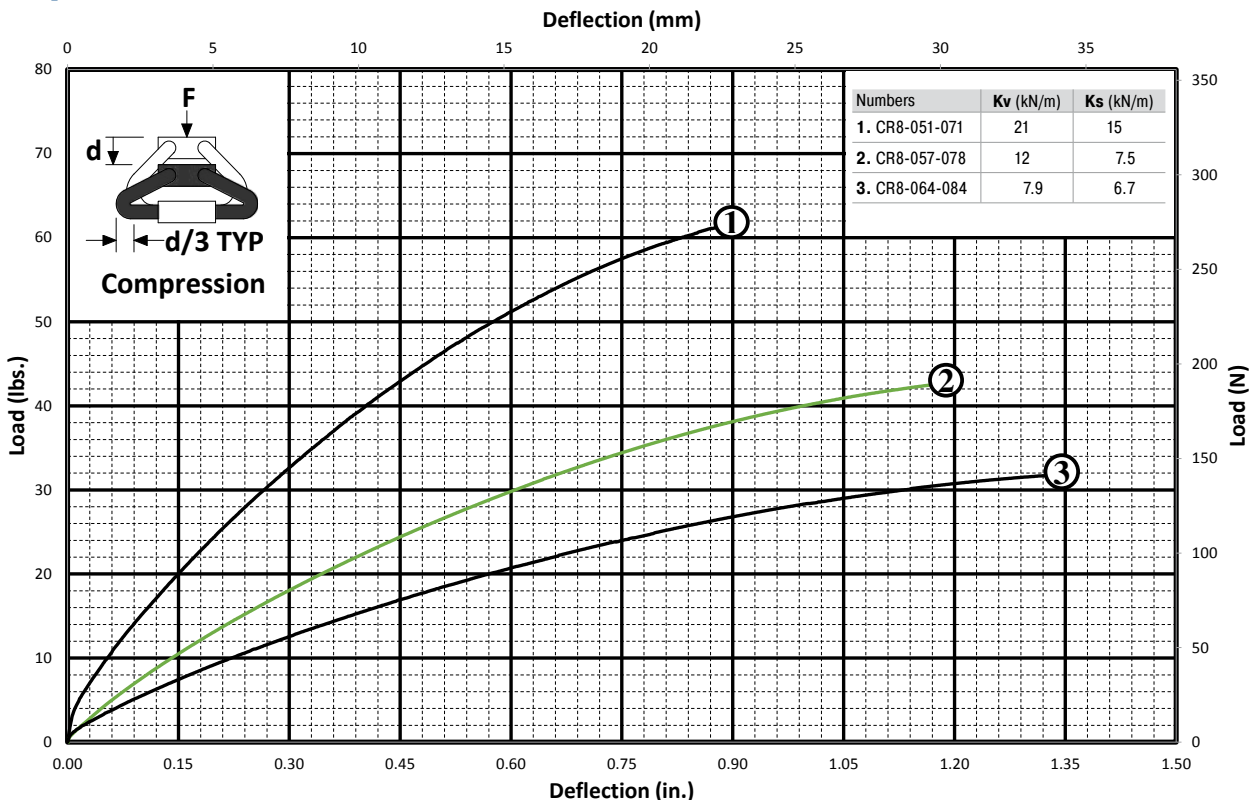



## Roll

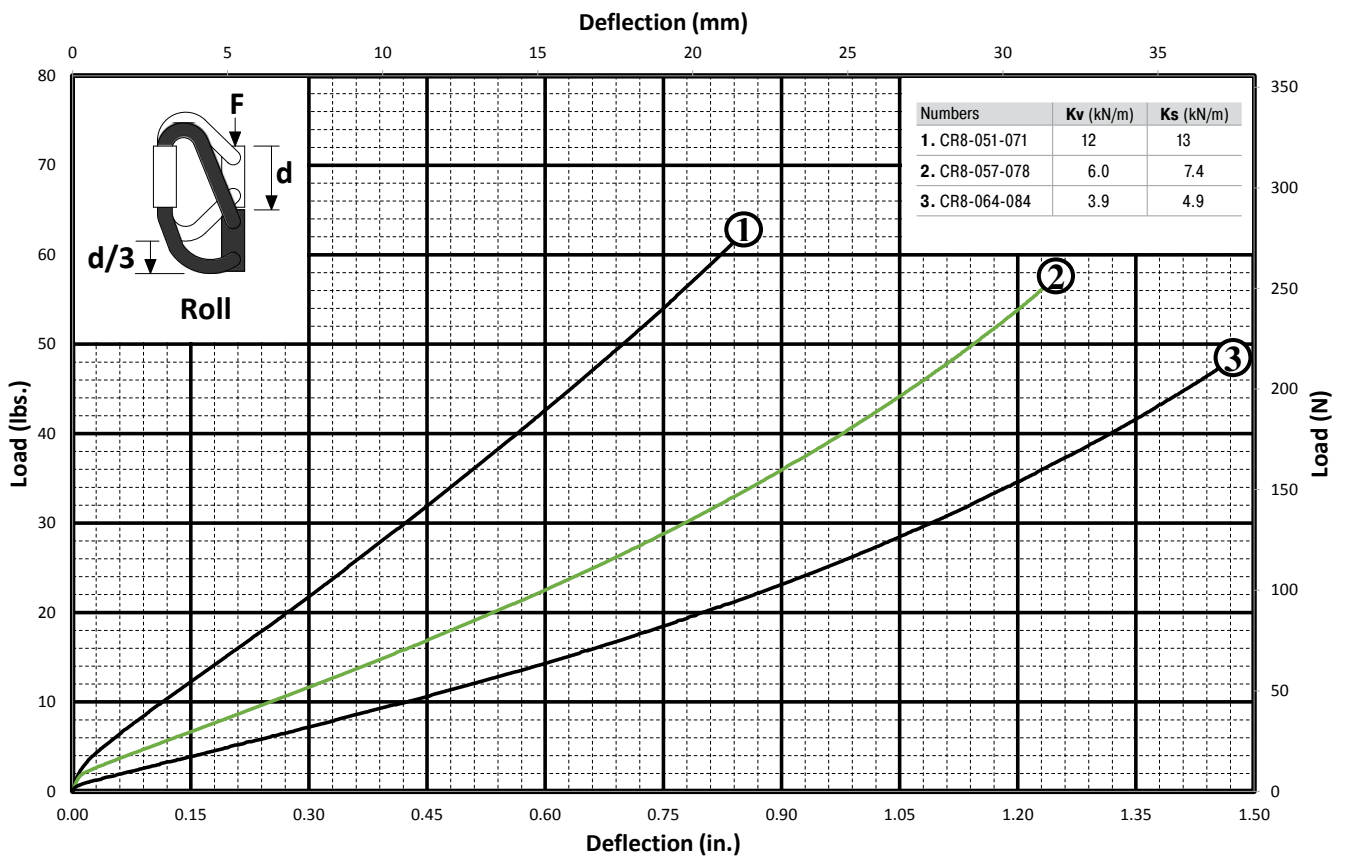

## 45° Compression/Roll

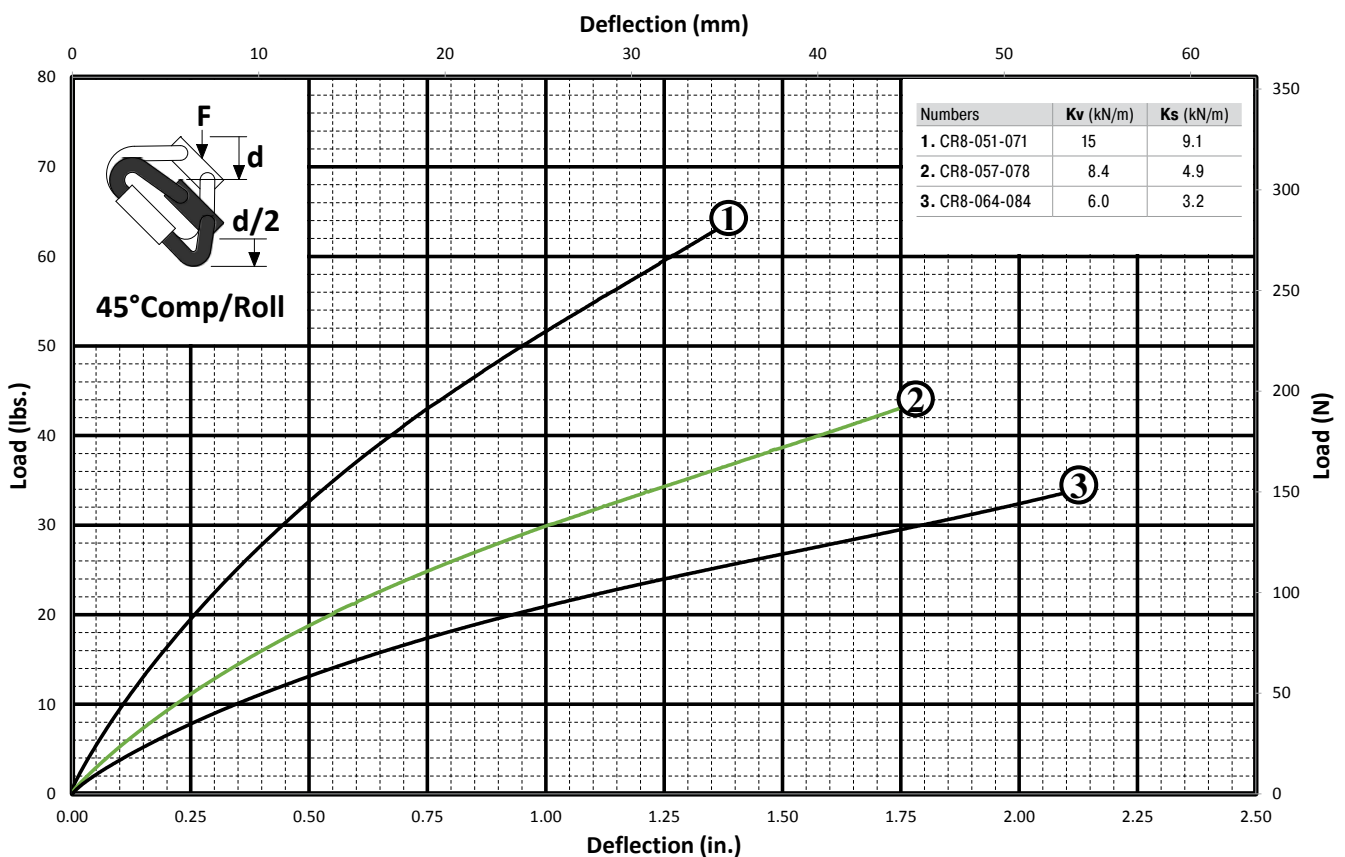

## ACE Germany

The shortest way to the perfect shock absorber



### ACE Stoßdämpfer GmbH

PO Box 1510  
40740 Langenfeld

Albert-Einstein-Straße 15  
40764 Langenfeld

Germany

T +49 (0)2173 - 9226-4100

F +49 (0)2173 - 9226-89



[info@ace-int.eu](mailto:info@ace-int.eu)

[www.ace-ace.com](http://www.ace-ace.com)

## Global but always near

### International ACE Sales Locations



GREAT BRITAIN  
**ACE Fabreeka UK**

Unit 404 Easter Park, Haydock Lane  
Haydock, WA11 9TH, U.K.

T +44 (0)1942 - 727 440

F +44 (0)1942 - 717 273

[www.ace-controls.co.uk](http://www.ace-controls.co.uk)



JAPAN  
**ACE Controls Japan L.L.C.**

City Center Bldg. II 2fl  
3-1-42, Chigasaki-minami, Tsuzuki-ku  
Yokohama, 224-0037, Japan

T +81 (0)45 - 945-0123

F +81 (0)45 - 945-0122

[www.acecontrols.co.jp](http://www.acecontrols.co.jp)



P.R. CHINA  
**ACE Controls**

No. 8 Longxiang Road, Wujin National High-tech Industrial Zone,  
Changzhou, Jiangsu Province, CN-213164, P. R. China

T +86 (0)519 - 8622-3520

F +86 (0)519 - 8622-3550

[www.ace-ace.cn](http://www.ace-ace.cn)



USA  
**ACE Controls International Inc.**

23425 Industrial Park Dr., Farmington Hills  
Michigan 48335, USA

T +1 248 - 476-0213

F +1 248 - 476-2470

[www.acecontrols.com](http://www.acecontrols.com)

