

EEL-S2-2



Bansbach
easylift

EEL-S2-2 Advanced Actuator Controller

Features:

- Precise position control from
- analog voltage input
- Adjustable start ramp
- Adjustable stop ramp
- Settable current limit
- High efficiency
- High momentary load capacity
- DIN-rail base fittable
- “Position reached” - signal

Technical Data

- Supply voltage: 10-35VDC
- Ripple: Less than 20%
- Actuator current continuous max: 15A ($T_a < 60^\circ\text{C}$)
- Actuator current max: 20A (short time)
- Current limit adj.: 0.1-20A
- Overheat limit: 100°C
- PWM frequency: 2kHz
- Hall input freq.: Max 1kHz
- Input control logic (pos.):
 - High=4-30V,
 - Low=0-1V or open
- Control input impedances typ.: 30kohm
- Motor and supply connectors: 2.5mm wires max
- Control connectors: 1mm wires max
- Dimensions: 73x43x25mm (LxWxH)
- Weight: 75g
- Operating temp: -20° to +70°C
- Idle current: 45mA

The S2-2 actuator controller provides advanced positioning and control of actuators through easy and flexible integration with the application. The controller is designed to work with Bansbach easyE-line actuators in applications where positioning is required. S2-2 has adjustable start and stop ramps, which make smooth starts and stops possible.

Adjustable current limits in both directions protect the motor against overcurrent. In learning mode the number of hall pulses in a full stroke of the actuator is counted which enables accurate positioning during normal operation.

The position of the actuator is controlled by a DC voltage between 0-5 or 0-10 Volts to the S2-2. Adjustments and parameter settings like current limit value, ramp times, speed etc. are set with S2-PROG interface unit or S2-USB “dongle” connected to a PC.

Wiring S2-2

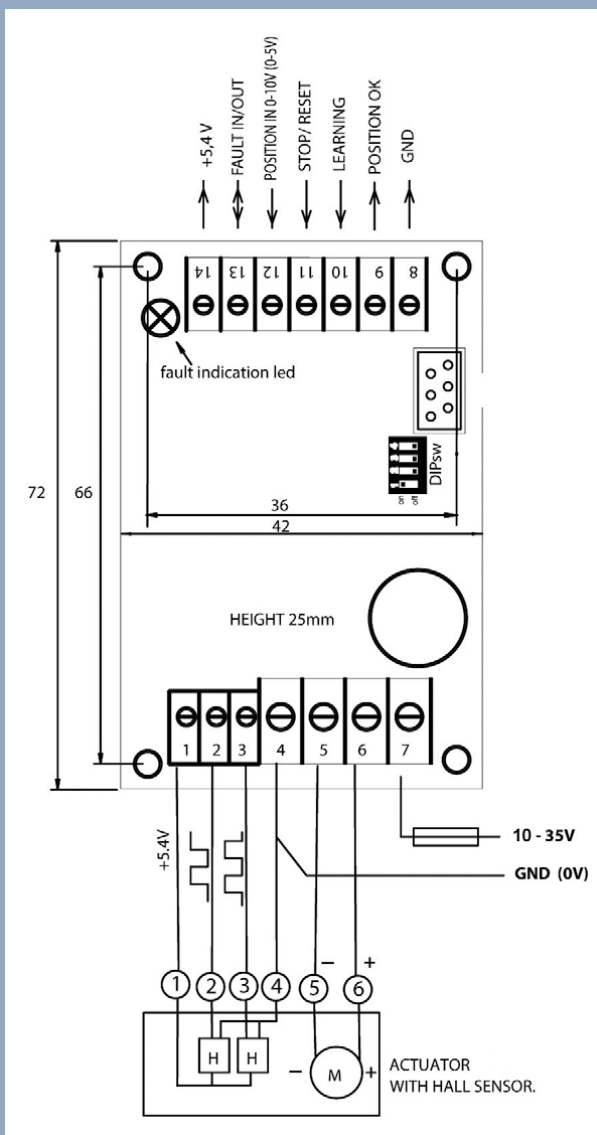

Circuit diagram

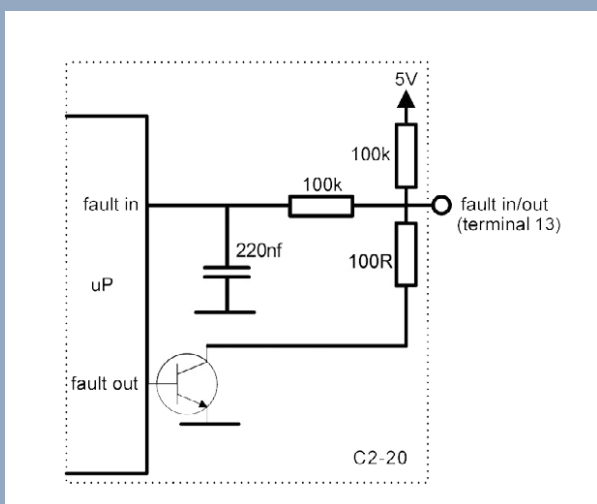

Screw Terminals

- Supply for hall sensors (+5V output)**
- Hall channel A**
- Hall channel B**
- GND (0V) and gnd for hall**
- Actuator -**
- Actuator +**
- Supply**
10–35 VDC (Use fuse)
- GND (0V)**
- Position OK**
Digital output 5V through 1kO when wanted position is reached and low during travel.
Note: If “stop ramp” is very long, then POSITION OK signal can be difficult to reach, since the motor only gets very low power to reach within the “dead zone”
- Learning**
Digital input (>4V and max supply voltage) starts “learning”. Rin 47kO
- Stop/Reset**
Digital input (>4V and max supply voltage) Stops the motor and resets any fault. Rin 47kO
- Pos. Set**
Analog input
DIPsw 1 on=0-10,8V
DIPsw 1 off=0-5,4V
DIPsw 2-4 not used
Rin 30kO
- Fault IN/OUT**
NPN open collector max 100mA can be connected to other S2-2 modules, thereby all modules connected will stop if one module sends a FAULT signal. If wire length is more than 1 meter, a 10kO pull-up resistor connected to supply is recommended. Diagram in FIG 2
- +5,4V output, max 10mA**

Wiring and Settings

First run the learning cycle and then do the settings with serial interface unit "S2-PROG" or PC.
Default values in ()

1/15	Speed: 35 - 100% \Leftrightarrow 35-100 (100)	<i>limits the maximum speed.</i>
2/15	Learning speed: 35 - 100% \Leftrightarrow 35-100 (50)	<i>sets the learning cycle speed.</i>
3/15	I-limit "forward": 0,1 - 20,0A \Leftrightarrow 1-200 (20)	<i>are individual for reverse and forward directions.</i>
4/15	I-limit "reverse": 0,1 - 20,0A \Leftrightarrow 1-200 (20) Notice! Current limits are 1.5 times higher during start ramp and 1 sec. thereafter	
5/15	I-trip enable: 0/1 \Leftrightarrow off/on (1)	<i>enables the trip function, so that motor will be shut down when the set I-limit is exceeded. Motor has to be started in opposite direction after trip.</i>
6/15	I-trip delay: 0 - 255ms \Leftrightarrow 0 - 255 (5)	<i>defines the reaction time for trip.</i>
7/15	Load compensation: 0 -255 \Leftrightarrow 0 - 255 (0)	<i>increases the torque at low speed. Note that over-compensation will cause oscillation and twitching of the motor.</i>
8/15	Pulse lost timeout: 1 - 5s \Leftrightarrow 1 - 5 (2)	<i>stops motor after the set time without pulses.</i>
9/15	Start value: 0 - 50% \Leftrightarrow 0 - 50 (30)	<i>is a voltage level for start (% of full), this ensures that the motor gets an adequate voltage to start properly, but note that too high start level will cause motor vibration (FIG. 3).</i>
10/15	Hour/Start count reset: 0 - 1, reset when set to 1	<i>makes possible to set the hour/start counter to zero.</i>
11/15	Stop ramp: 0,0 - 20,0% \Leftrightarrow 0 - 200 (50)	<i>is proportional value of the full stroke. In low speed application good value is near 1%, and in high speed solution it can be near to 20% (FIG. 3).</i>
12/15	Dead zone: 0,0 - 10,0% \Leftrightarrow 0 - 100 (10)	<i>is steady area, suitable size of this zone depends on the mechanical accuracy of the system, this value is also a ratio of the full stroke (%) (FIG. 3).</i>
13/15	Range scale in: + 0,0 - 50,0% \Leftrightarrow 0 - 500 (7)	<i>adjustment is for scaling of the stroke, with this scale can be adjusted after learning. The reverse and forward ends are individually scaleable to get the suitable mechanical stroke for set value from 0-10V (0-5V) (FIG. 5).</i>
14/15	Range scale out: - 0,0 - 50,0% \Leftrightarrow 0 - 500 (70)	
15/15	Start ramp: 0,1 - 5s \Leftrightarrow 0 - 500 (100)	<i>defines the time before reaching full speed.</i>

Status LED Signals:

1. Fast blinking = Stopped due to current limiter active
2. Slow blinking = Overtemperature
3. 2x short, mid, long... = Hall pulse lost
4. 4x fast blinking (burst), pause = Overvoltage
5. 2x short, 1x long = Fault in
6. LED permanent on = Learning not completed, new learning required

FIG. 3

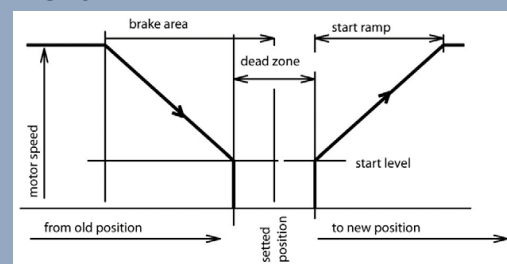
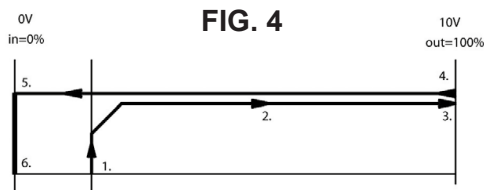
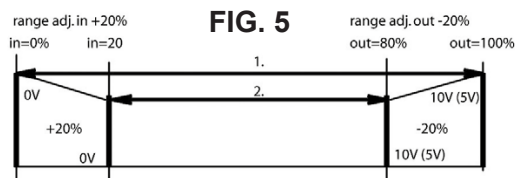

FIG. 4



1. Start learning by giving an impulse to learn input (10)
2. Motor starts to run "out" direction with learn speed
3. Current limit stops the motor when mechanical end is reached
4. Motor starts to "in" direction and makes a full stroke.
During stroke the pulse counter measures the range.
5. Motor reaches the mechanical end "in", and current limit stops the motor.
6. Device stores full range value and is ready for use

FIG. 5



1. Original learned range = mechanical full range equals the signal range 0-10V (0-5V)
2. Modified range example:
If range scale in = +20% and range scale out = -20%.
now stroke of actuator is compressed to:
positioning set value 0V = 20% position
positioning set value 10V (5V) = 80% position

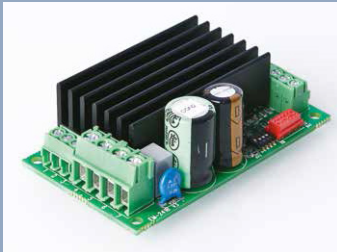

EEL-S2-2-A

(board alone)
73 x 43 x 25 mm (L x W x H)



EEL-S2-2-B

(box version)
102 x 73 x 47 mm (L x W x H)

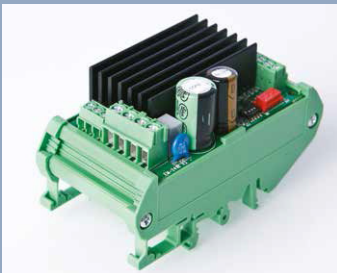

EEL-S2-2-D

(DIN rail version)
90 x 46 x 56 mm (L x W x H)



Accessories

- EEL-S2-PROGUSB
Programming cable for PC
- EEL-S2-PROG
Programming unit
- EEL-S2-ADAP
Minifit-Adapter

Warnings and recommendations

- If S2-2 goes into “trip” (overcurrent) it is only possible to run actuator in opposite direction.
- Please adjust the max. current to be 10% higher than maximum current during load. This ensures the longest actuator lifetime.
- Please ensure that the power supply for the controller is capable of supplying sufficient current – otherwise the controller and the actuator may be damaged.
- Doublecheck correct polarity of power supply. If connected wrong the S2-2 will be damaged.
- Attention! S2-2 has no fuse in it. Use external fuse according to application (2 -> 10A slow).
- Bansbach does not have any responsibility over the possible errors in this data sheet.
- Specifications are to be changed without notice.

The flyer is subject to technical alterations and printing mistakes.

Bansbach easylift GmbH

Barbarossastraße 8
D-73547 Lorch

Tel. +49 (0) 7172/9107-0
Fax +49 (0) 7172/9107-44

info@bansbach.de
www.bansbach.de

Bansbach
easylift

03/2018