



**MICRON**

# TRUE Planetary™ Gearheads



*Helping you build a better machine, faster.*

## Product Overview

### NemaTRUE™



**Cost-effective and flexible thanks to the modular RediMount™ motor mounting system**  
Low-backlash planetary gearhead

### DuraTRUE™



**Precise, compact and low maintenance thanks to TRUE planetary™ gearing**  
Low-backlash planetary gearhead

### DuraTRUE 90™



**Up to 98% efficiency with the PowerTRUE™ right-angle gearing**  
Low-backlash right-angle planetary gearhead

### UltraTRUE™



**Optimum smooth running characteristics, torque capacity and precision thanks to crowned helical gearing**  
Low-backlash planetary gearhead

### UltraTRUE 90™



**One of the quietest and smoothest right-angle planetary gearheads on the market**  
Low-backlash right-angle planetary gearhead

### EverTRUE™



**Rigorous design concept to ensure a service life of at least 30,000 hours in continuous operation**  
Low-backlash planetary gearhead







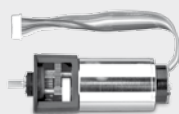

### EQ Series



**Low noise and low vibration thanks to patented “Swing Link” technology**  
Planetary gearhead



**Let us provide a unique solution for your specific gearhead requirements**  
Customised gearhead solutions

	NemaTRUE™	DuraTRUE™	DuraTRUE 90™			UltraTRUE™	UltraTRUE 90™	EverTRUE™	EQ Series
									
Torque capacity [Nm] up to	180	834	842	865	865	3300	3111	1010	29
Ratio min. i =	3	3	1	1	1	4	1	4	3
max. i =	100	100	500	500	500	100	50	100	100
Radial load capacity [N] up to	3730	11150	11150	11150	11150	37910	37778	44600	1516
<b>Mounting Form</b>									
Right angle			●	●	●		●		
In-line	●	●				●		●	●
<b>Torsional Backlash</b>									
≤ 4 arcmin						●	●	●	
≤ 8 arcmin	●	●	●	●	●				
≤ 13 arcmin	●								
≤ 18 arcmin									●
<b>Input Form</b>									
Motor mounting	●	●	●	●	●	●	●	●	●
RediMount™ system	●	●	●	●	●	●	●	●	●
<b>Output Form</b>									
Single shaft	●	●	●			●	●	●	●
Dual shaft					●				
Hollow shaft				●					
<b>Gearing</b>									
TRUE planetary™ gearing	●	●	●	●	●			●	●
Helical crowned gearing						●	●		
PowerTRUE™ right angle gearing			●	●	●		●		
<b>Frame Size</b>									
60	●	●	●		●	●	●		●
75						●	●		
90	●	●	●	●	●	●	●		
100						●	●	●	
115	●	●	●	●	●	●	●		
140						●	●	●	
142		●	●	●	●				
180						●	●	●	
220						●			

# TRUE Planetary™ Gearheads

for high precision motion control applications which require a high torque to volume ratio, high torsional stiffness and low backlash.

- High torque to size ratio - allows compact design
- Low backlash - eliminates positioning errors due to lost motion
- Inertia matching - keeps servo system stable and in control
- High rigidity - optimizes system response
- Self re-lubrication - eliminates costly maintenance and downtime
- High radial load capacity - mount pulleys and pinions directly on the output shaft

- 1 Output shaft**
- 2 Tapered roller bearings**  
provide high axial and radial load carrying capacity
- 3 Anodized aluminum housing (DuraTRUE™)**  
**Stainless steel housing (UltraTRUE™, EverTRUE™)**
- 4 HRC 55-60 steel gears** provide superior wear resistance and increased backlash integrity
- 5 Sealed deep groove ball bearing**  
provides high radial load carrying capability
- 6 RediMount™ system**  
provides error-free motor installation

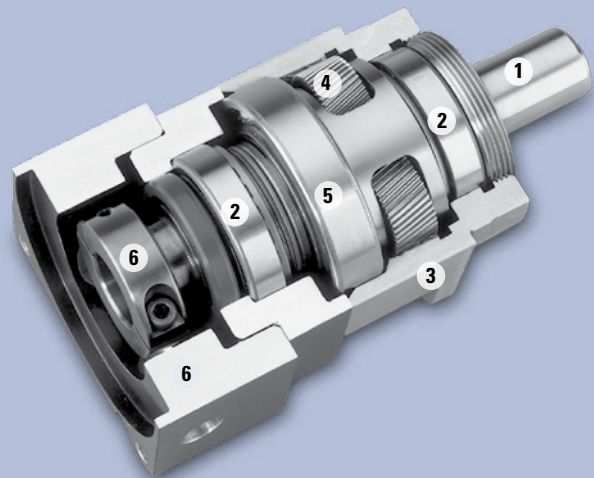

## Custom Engineered Solutions developed in close cooperation with you.

- Concept to prototype within weeks
- Compact integrated servo-actuator solutions
- Precision gearing to AGMA 14 standards
- ISO 9001 certified with in-house product testing and fully accredited metallurgical lab



# Helical Crowned TRUE Planetary™ Gearheads

combine the positive attributes of gear crowning and helical gearing with the planetary construction to create the smoothest operating gearhead on the market.

- High Torque Capacity
- Low Backlash
- Smooth Operation
- Greater Load Sharing
- Whisper Quiet

Helical gears are known for their quiet and smooth operation along with their ability to transmit higher loads than spur gears.

Crowning is a modification to the gear tooth profile which optimizes gear mesh alignment. It also enhances distribution of loading on the tooth flank, thereby reducing high stress regions which can result in surface pitting.

## Spur vs. helical gearing

The Contact ratio is defined as the number of teeth in mesh at any given time. The higher the contact ratio, the higher the torque rating of the gearing. Helical gearing has more than 2x the contact ratio of spur gearing.

## Crowned vs. non-crowned

Crowning optimizes the gear mesh alignment within a gear train to increase the torque capacity and reduce noise. It also enhances load distribution on the tooth flank to reduce high stress regions.



UltraTRUE in-line planetary™ gearhead with helical gearing

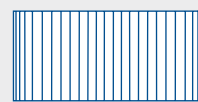

Typical contact ratio is 1.5 for spur gearing.

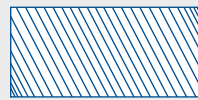

Contact ratio for equivalent helical gear is 3.3... more than double the contact ratio.

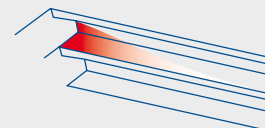

Non-crowned  
High stress region

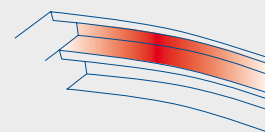

Crowned  
Even load distribution

# TRUE Planetary™ Gearheads

for high precision motion control applications which require a high torque to volume ratio, high torsional stiffness and low backlash.

- High torque to size ratio - allows compact design
- Low backlash - eliminates positioning errors due to lost motion
- Inertia matching - keeps servo system stable and in control
- High rigidity - optimizes system response
- Self re-lubrication - eliminates costly maintenance and downtime
- High radial load capacity - mount pulleys and pinions directly on the output shaft

- 1 Output shaft**
- 2 Anodized aluminum housing (DuraTRUE™)  
Stainless steel housing (UltraTRUE™, EverTRUE™)**
- 3 HRC 55-60 steel gears** provide superior wear resistance and increased backlash integrity
- 4 Innovative PowerTRUE™ gearing** delivers smooth, quiet geared reduction
- 5 RediMount™ hub** provides error-free motor installation
- 6 RediMount™ input housing** provides error-free motor installation

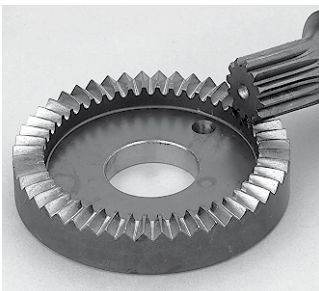
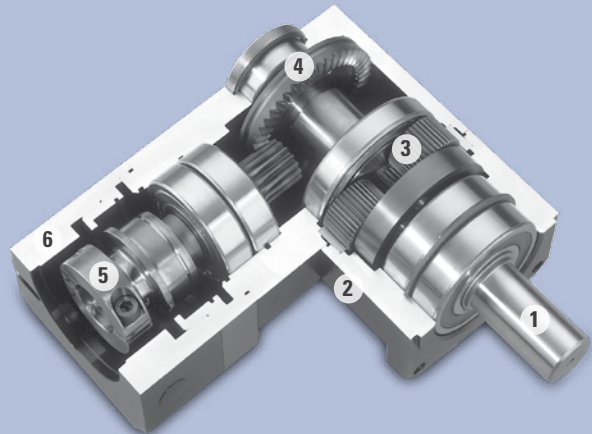

PowerTRUE™ right angle gearset



CNC machining of a PowerTRUE™ right angle gear

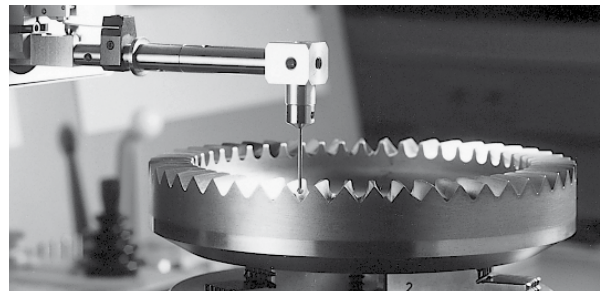

Computerized mapping of gear tooth profile

## RediMount™ Motor Mounting System

allows an easy, error free and quick connection of our Micron gearheads to any current motor in the market. The innovative design with adapter sleeve and input housing features mounting the Micron gearhead within one working process.

- Self-aligning hub - Maintains concentricity between motor shaft and gearhead
- Pre-installed pinion - Eliminates pinion setting procedure
- Modular design - Allows gearhead and input housing to be stocked separately
- Flexibility - Allows easy changeover to alternate motors
- Interchangeability - Same RediMount™ system is used throughout 7 product lines

**RediMount™ offers an easy and error free connection between motor and gearhead in only a few minutes:**

1. Slide the supplied sleeve into the gearhead hub.
2. Slide the gearhead hub onto the motor shaft.
3. Tighten the hub bolts through the assembly holes of the input housing.
4. Bolt the motor to the gearhead with the bolts provided.

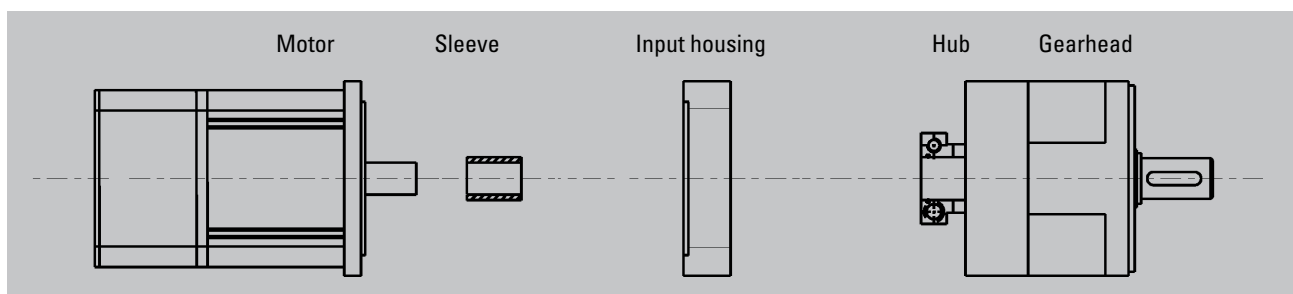

**EUROPE****UK**

Danaher Motion  
Chartmoor Road, Chartwell Business Park  
Leighton Buzzard, Bedfordshire  
LU7 4WG; United Kingdom  
Phone: +44 (0)1525 243 243  
Fax: +44 (0)1525 243 244  
E-mail: salesuk@danahermotion.com

**France**

Danaher Motion  
C.P 80018  
12, Rue Antoine Becquerel – Z.I. Sud  
F – 72026 Le Mans Cedex 2  
France  
Phone: +33 (0) 243 50 03 30  
Fax: +33 (0) 243 50 03 39  
E-mail: sales.france@tollo.com

**Germany**

Danaher Motion GmbH  
Wacholderstr. 40-42  
D-40489 Düsseldorf  
Germany  
Phone: +49 (0) 203 9979-0  
Fax: +49 (0) 203 9979 155  
E-mail: sales.germany@danahermotion.com

**Italy**

Danaher Motion srl  
Largo Brughetti  
I - 20030 Bovisio Masciago  
Italy  
Phone: +39 0362 594260  
Fax: +39 0362 594263  
E-mail: info@danahermotion.it

**Sweden**

Danaher Motion Stockholm AB  
Solkraftsvägen 13  
SE-135 70 Stockholm  
Sweden  
Phone: +46 (0) 8-682 64 00  
Fax: +46 (0) 8-682 65 80  
E-mail: info@danahermotion.se

**Switzerland**

Danaher Motion SA  
La Pierreire 2  
1029 Villars-Ste-Croix  
Switzerland  
Phone: +41 (0) 21 631 33 33  
Fax: +41 (0) 21 636 05 09  
E-mail: info@danaher-motion.ch

**USA, CANADA or MEXICO**

Danaher Motion  
203A West Rock Road  
Radford, VA 24141 USA  
Phone: 1-540-633-3400  
Fax: 1-540-639-4162  
E-mail: DMAC@danahermotion.com

**ASIA****China**

Danaher Motion  
Rm 2205, Scitech Tower  
22 Jianguomen Wai Street  
Beijing, China, 100004  
Phone: +86 10 6515 0260  
Fax: +86 10 6515 0263  
E-mail: chinainfo@danahermotion.com.cn

**Japan**

Danaher Motion Japan  
3F, 2nd Nagaoka Bldg  
2-8-5, Hacchobori, Chuo-ku  
Tokyo 104-0032 Japan  
Phone: +81-3-6222-1051  
Fax: +81-3-6222-1055  
E-mail: info@danahermotion.com