

# Digital pressure sensor PPX series

## DIGITAL PRESSURE SENSOR PPX SERIES



# Easy to check with dual digital

New easy-to-use high-function digital pressure sensor PPX series with dual display to check (current value) and (set value) of pressure at the same time, 3-color display, copy function of setting details, and 3-mode setting, etc.

## Direct setting with dual display

The main screen to display "current value" and the sub screen to display "set value" are compactly incorporated.

The set value can be adjusted and set with [current value] displayed. The screens turns ON/OFF during setting, so usable as volume type sensor.

Key lock is also equipped.

Comparison output 1  
operational indicator light

Comparison output 2  
operational indicator light  
(High function type having analog  
voltage output operation display)

Compact size of  
□30 X 25.5



Current value

[Main display section]

Set value

[Sub-display section]

Setting DOWN key

Setting UP key

## Mode switchover key

### RUN MODE

Setting adjustment and key lock, etc. are possible during operation.

### MENU SETTING MODE

Basic setting such as output mode setting and NO/NC switching is possible.

### PRO MODE

High-function setting such as copy function and sub-display section change is possible.

## 3-mode setting to match applications

The operation mode is designed according to setting applications as daily operation setting "RUN MODE", basic setting "MENU MODE" and high function "PRO MODE".

Operation and setting are very easy.

Digital pressure sensor

# PPX Series



# display!

## 3-color display (red/green/orange)

The main display section is changed to green/red in accordance with output ON/OFF, and orange during setting. The sensor state is easily read.

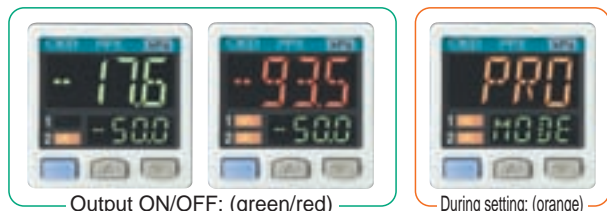

Output ON/OFF: (green/red)

During setting: (orange)

## Copy function to reduce man-hours and to prevent mistake

The copy of sensor setting details can be quickly made to other sensors with data communication. Problems caused by incorrect installation is prevented if the same setting is applied to several units.

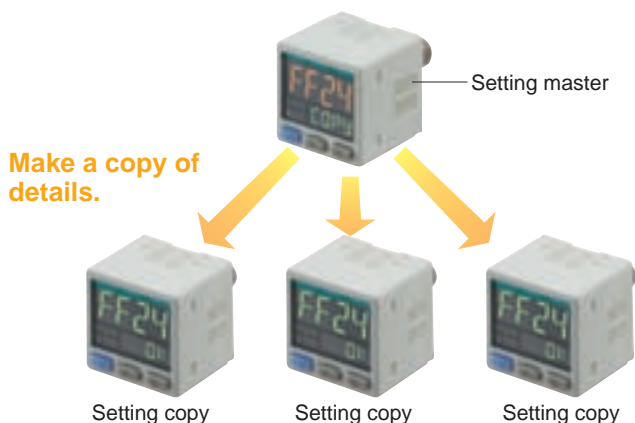

Make a copy of details.

Setting copy

Setting copy

Setting copy

## Customized sub-display section

Alphabet and number other than the setting can be displayed in the sub-display section. Troubles of putting labels such as normal pressure range and equipment No. are saved.



<Unit display>

<Number display>

<Specified character display>

## Model for foreign markets available

Unit switching available  
(MPa, kPa, kgf/cm<sup>2</sup>, bar, psi, mmHg, inchHg)



## CE Marked products

## RoHS directive compliant



## Independent two outputs are equipped (standard type)

2 independent comparison outputs are provided, so either detection mode can be selected.

### [3 detection mode]

- **EASY MODE**  
ON/OFF control of comparison output
- **Hysteresis mode**  
ON/OFF control with hysteresis setting of comparison output
- **Window comparator mode**  
Comparison output ON/OFF control within set pressure range

## High-function type meeting different applications

High-function type to select analog voltage output or external input instead of comparison output in the other side is available to meet different applications.

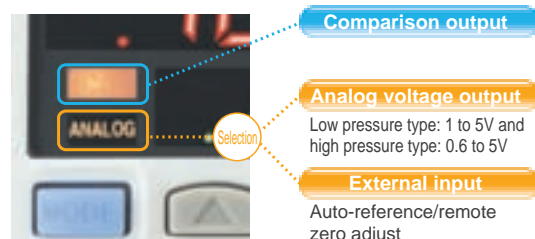

Comparison output

Analog voltage output

Low pressure type: 1 to 5V and high pressure type: 0.6 to 5V

External input

Auto-reference/remote zero adjust

## Easy to operate

### Easy-to-read alpha-numeric display

Alpha-numeric with 12-segment is provided. Alphabet and number are easily read.



### Peak/bottom hold

Maximum and minimum values of fluctuated pressure is displayed with using two screens.

### Response time change possible with 10 steps (2.5ms to 5000ms)

### Setting details display possible with code no.

## Energy saving mode equipped

Power consumption reduced by 30 to 40% (with lower brightness of display section and turning off the light)

## Space saving

Contact installation possible



# Digital pressure sensor applications

## ● Positive pressure and vacuum confirmation or interlock

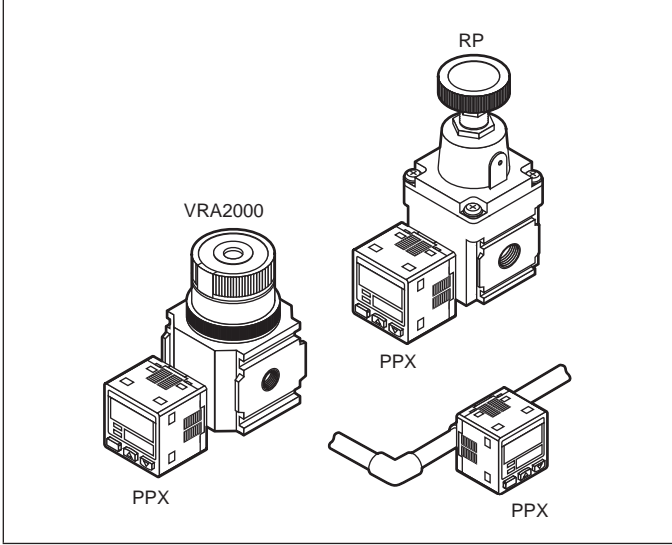

## ● Leakage inspection (high-function type)

- Easy setting with auto-reference/remote zero adjusting

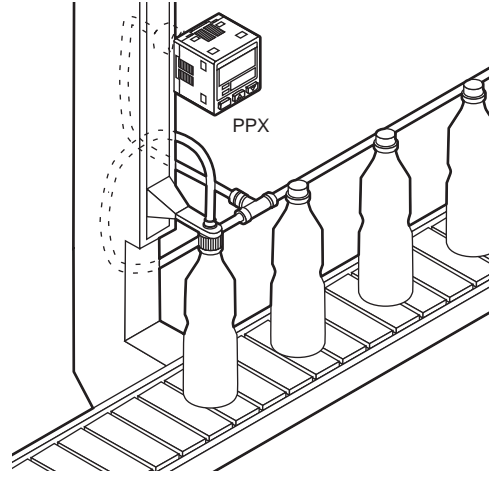

## ● Manifold

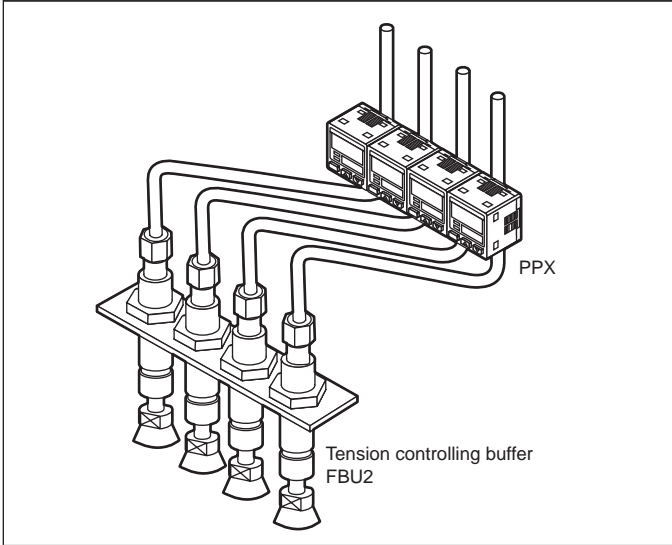

## ● Both vacuum pressure and break pressure can be controlled with a single unit.

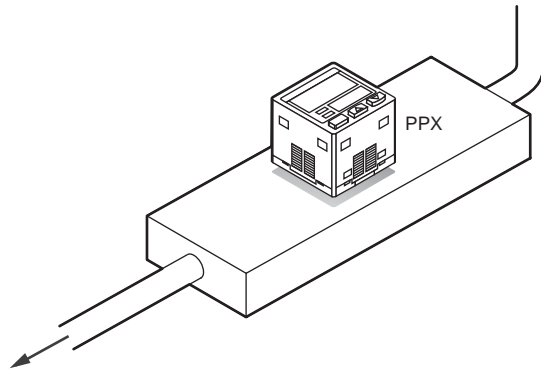

## ● Contact confirmation

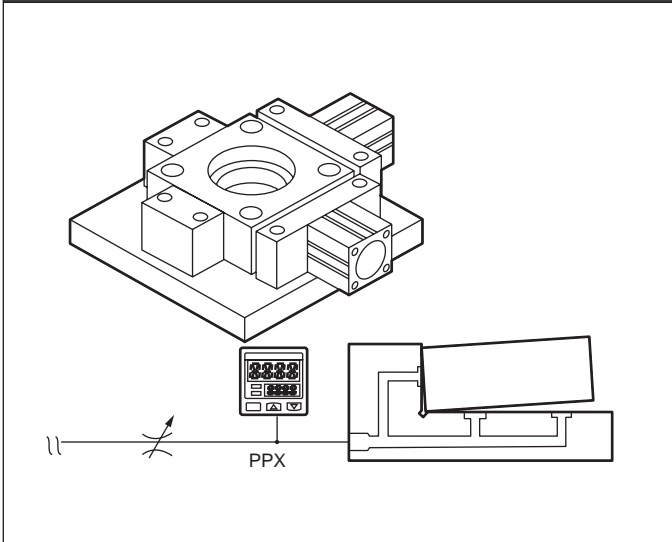



# Safety precautions

Always read this section before starting use.

When designing and manufacturing a device using CKD products, the manufacturer is obligated to check that device safety mechanical mechanism, pneumatic control circuit, or water control circuit and the system operated by electrical control that controls the devices is secured.

It is important to select, use, handle, and maintain the product appropriately to ensure that the CKD product is used safely.

Observe warnings and precautions to ensure device safety.

Check that device safety is ensured, and manufacture a safe device.

## WARNING

**1** This product is designed and manufactured as a general industrial machine part. It must be handled by an operator having sufficient knowledge and experience in handling.

**2** Use this product in accordance of specifications.

Contact CKD when using the product outside the unique specifications range, when using it outdoors, and when using it under the conditions and environment below. Do not attempt to modify or additionally machine the product.

- ① Use for special applications requiring safety including nuclear energy, railroad, aviation, ship, vehicle, medical equipment, equipment, or applications coming into contact with beverage or food, amusement equipment, emergency shutoff circuits, press machine, brake circuits, or for safeguard.
- ② Use for applications where life or assets could be adversely affected, and special safety measures are required.

**3** Observe corporate standards and regulations, etc., related to the safety of device design and control, etc.

ISO4414, JIS B 8370 (pneumatic system rules)

JPAS 005 (principles for pneumatic cylinder use and selections)

Such as High Pressure Gas Maintenance Law and Occupational Safety and Sanitation Laws, other safety rule and corporate standards and regulations

**4** Do not handle, pipe, or remove devices before confirming safety.

- ① Inspect and service the machine and devices after confirming safety of the entire system related to this product.
- ② Note that there may be hot or charged sections even after operation is stopped.
- ③ When inspecting or servicing the device, turn off the energy source (air supply or water supply), and turn off power to the facility. Discharge any compressed air from the system, and pay enough attention to possible water leakage and leakage of electricity.
- ④ When starting or restarting a machine or device that incorporates pneumatic components, make sure that the system safety, such as pop-out prevention measures, is secured.

**5** Observe warnings and cautions on the pages below to prevent accidents.

■ The safety cautions are ranked as "DANGER", "WARNING" and "CAUTION" in this section.

** DANGER:** When a dangerous situation may occur if handling is mistaken leading to fatal or serious injuries, or when there is a high degree of emergency to a warning.

** WARNING:** When a dangerous situation may occur if handling is mistaken leading to fatal or serious injuries.

** CAUTION:** When a dangerous situation may occur if handling is mistaken leading to minor injuries or physical damage.

Note that some items described as "CAUTION" may lead to serious results depending on the situation. In any case, important information that must be observed is explained.



Pneumatic components (electronic pressure switch and sensors)

## Safety precautions

Always read this section before starting use.

Refer to "Pneumatic, vacuum and auxiliary components CB-024SA".

### Design & Selection

#### WARNING

##### ■ Use this product in accordance of specifications.

- Applications, load current, voltage, temperature, shock and working environment, etc. exceeding the specifications range could lead to destruction and malfunction of peripheral equipment.

##### ■ Do not use oxygen, corrosive or combustible gas, or toxic fluid for this product.

##### ■ Do not use this product in flammable atmosphere

- The pressure switch is not explosion proof. Do not use this product in flammable atmosphere, or explosions could occur.

##### ■ Do not install the product in completely sealed enclosure.

- The internal pressure in the closed chamber could change if the fluid leaks in an accident. Use this product in the control box with safety device to control internal pressure, or indoors with no pressure differential from the outside.

##### ■ Power voltage

Use the product within the specified power voltage range. If voltage exceeding specified range is applied, or alternating current power (100 V AC) is applied, circuit damage could occur.

##### ■ Load short circuit

Do not short-circuit the load, or circuit damage could occur.

##### ■ Incorrect wiring

Avoid incorrect wiring such as connecting to the wrong electrode of the power source, etc., or the circuit damage could occur.

#### CAUTION

##### ■ Working fluid

When using working fluid other than air; nitrogen gas, etc., oxygen deficiency could be caused. Observe the following instructions.

- Use this product in well ventilated location.
- Ventilate the work area when nitrogen gas is being used.
- Inspect piping regularly, so nitrogen gas does not leak.

##### ■ If this product is used for vacuum suction confirmation, care must be taken for following matters.

- The pressure exceeding withstanding pressure in the specifications must not be applied to the product if positive pressure of vacuum break is applied.

##### ■ Working environment

- Avoid use in the place that vibration or shock not less than 100m/s<sup>2</sup> is applied.

- Care must be taken in not exceeding media and ambient temperature range in cluding piping area.
- Do not use the product in locations that water or oil may contact the products.

##### ■ Considering errors, etc. caused by precision/temperature characteristics, decide the setting.

##### ■ Care must be taken when this product is used in an interlock circuit.

- When a pressure switch is used to issue interlock signals, if high reliability is required, provide mechanical guards for a failure, or provide dual interlock as a switch (sensor) other than pressure switch is used. Execute inspection regularly to check that the normal operation is done.

##### ■ Responsiveness is adversely affected depended on working pressure and volume of loads. Install a regulator before the sensor if stable repeatability is required.

##### ■ Use conditions to comply with CE marking

- PPX series is CE marked products complied with EMC directive. EN61000-6-2; regulation matched to immunity applies to this product. Conditions below are necessary to comply with these standards.

##### Conditions

- Length of power line connected to the sensor is to be less than 10m.

##### ■ Take the following countermeasures to prevent malfunction caused by noise.

- Provide a line filter in AC power line.
- Do not share power with an inverter or components causing motor noise, etc.
- Remove noise from inductive load (such as solenoid valve and relay) with a surge suppressor such as CR or diode in the source side.
- When using components (such as switching regulator and inverter motor) causing noise around the sensor installation section, ground a frame ground (F.G.) terminal of components.
- Keep distance between a line connected to sensors and strong magnetic field.
- Connect a line connected to sensors with shield wire.
- Connect shield wire to the ground of power side.

##### ■ When the secondary side control pressure is released to atmosphere as air blow, pressure may fluctuate depended on piping and blow conditions. Execute a test under actual working conditions or contact to CKD.

##### ■ Select the product whose flow is not less than the total of that used for sensors when selecting a dryer, an air filter, an oil mist filter and a regulator.

## Installation & Adjustment

### **⚠️ WARNING**

- **Avoid incorrect connection.**
  - An incorrect connection may cause a fatal error not only to this product but also peripheral devices.
- **DC power not insulated from AC primary side may damage the product and power, so an electric shock could occur.**  
Do not use the product in this case.
- **If a switching regulator at store is used for power, ground a frame ground (F.G.) terminal of power.**

### **⚠️ CAUTION**

- Do not use the product where the product is exposed to direct-sunlight, or may come in contact with water or oil.
- Avoid use in high steam and dirt environments.
- Care must be taken to avoid product contact with organic solvents such as thinner, water, oil and fat.
- Do not put wire, etc. into the pressure port, or diaphragm may be damaged to prevent a normal operation.
- Performance could not be guaranteed in strong electromagnetic field.
- Flash air pipe connected to sensors before connecting. Prevent pipe from catching tips of sealing tape when piping.
- Apply adequate torque when connecting pipes.
  - Tighten by hand at first, then use a tool to prevent screw thread damaged.

Set screw	Tightening torque N·m
M3	0.3 to 0.6
M5	1 to 1.5
Rc1/8	3 to 5



### Piping

- Apply a 12mm spanner (14 mm for PPX-6G type) on the pressure port hexagon head section to fix, then apply tightening torque 9.8N·m or less if a joint at store is connected to the pressure port. A joint or the pressure port section could be broken if too much torque is applied.  
Use seal tape to connect joints to prevent air leak.

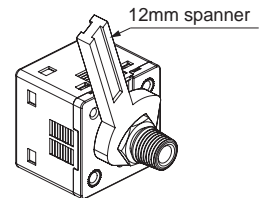

### Installation

#### **⚠️ WARNING**

- Sensor bracket PPX-KL is available.  
If a sensor is installed with a bracket, etc., tightening torque must be 0.5N·m or less.

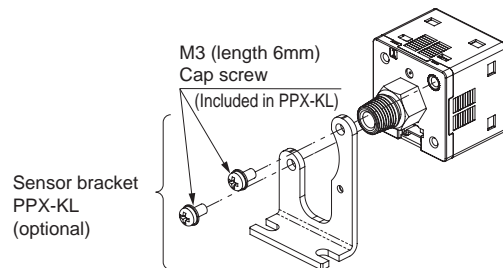

- Panel bracket PPX-KHS (optional) and front cover PPX-KCB (optional) are available.

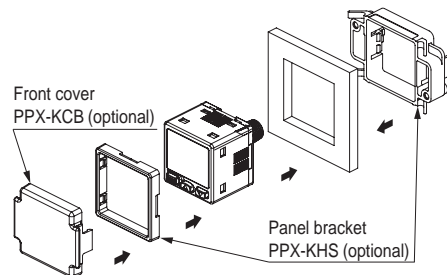

# Installation & Adjustment

## ⚠ CAUTION

### ■ Care must be taken for protection of body and lead wire.

- Do not apply stress to cable outlet or connector section directly.

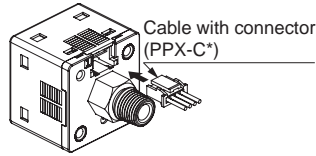

- Do not dent or drop the body. Do not apply excessive repeated bending force and tension to lead wire, or could result in disconnection.
- Connect an elastic material as a cable bearer to the movable part.

### ■ Connector wiring

- Insert cable with connector PPX-C\* into the connector section of this product as right when connection.
- Pull out the connector while pressing the jaw of cable with connector when disconnecting.
- If the cable section is pulled out without pressing the jaw when disconnecting, the cable or connector could be broken.

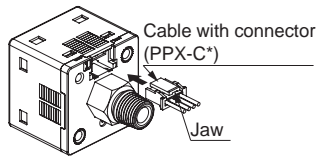

<Connector>  
 Contact: SPHD-001T-P0.5  
 Housing: PAP-04V-S  
 [JST MFG CO. LTD.]

#### <Connector pin layout drawing>

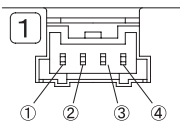

Connector pin No.	Terminal name
①	+V
②	Comparison output 1
③	Standard type: Comparison output 2 High-function type: Analog voltage output or external input
④	0V

- Use an applicable cable and crimp tools for housing and contact if connected with the connector set (PPX-CN).

#### <Applicable cable>

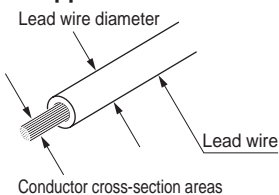

Conductor cross-section areas	0.12 to 0.32mm <sup>2</sup> (AWG26 to 22)
Lead wire diameter	Φ1.0 to Φ1.5mm
Wire	Annealed copper twist wire

Housing	JST MFG CO. LTD. PAP-04V-S
Contact	JST MFG CO. LTD. SPHD-001T-P0.5
Recommended crimp tools	JST MFG CO. LTD. YC-610R (AWG26 to 24)
	JST MFG CO. LTD. YC-611R (AWG22)

### ■ Wiring

- Connect cable with power turned OFF. Discharge static electricity charged in human body, tool or equipment before and during operation.
- Use safety power supply with ripple voltage 10% or less without noise.

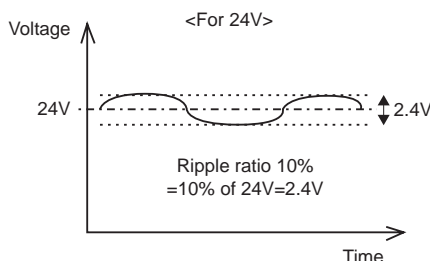

- Voltage must rise or fall quickly when power is turned ON or OFF. If the rated voltage is not reached, the sensor could malfunction. In some cases, the sensor could not recover after the rated voltage is reached. Reset the power in that case. Even if the voltage drops temporarily, shut down the power once, then turn ON the power again.
- Avoid use during the transient state (0.5s) when power turned ON.
- Install the product and wiring as far as possible from noise source such as a strong electric line, etc. Take other countermeasures for the surge from inductive loads on the power line.
- Do not operate the control unit, machinery or equipment suddenly after wiring. Due to wrong setting, signals not expected could be outputted. First stop control unit, machinery and equipment, while energize these to test. Set the target setting after test.
- Cable with 0.3mm<sup>2</sup> and over can be extended up to 100m. Note that the power line connected to this product must be less than 10m if used as a CE marked product.

### ■ Stop machinery and equipment, and check safety before setting switch output.

### ■ Operate the key with a fingertip. Knife, screwdriver and other hard tip tools or objects may damage the plastic film over the control.

### ■ Piping

- Apply seal tape or sealant to screw-in joint, then screw the joint into the port to avoid excessive torque. Apply a spanner on the metal section to tighten.
- When winding seal tape, wind the tape leaving 2mm and over open from the thread top. If seal tape extrudes from the thread top, seal tape chips could be created when screwed in. These chips could enter into the circuit, and cause malfunction.



- Use pipe 1m long, and do not apply tension and impact to the pipe. If longer pipe is used, tension not expected could be created by the pipe weight, vibration or impact. In this case, use an intermediate support to fix the pipe on the machine or equipment.

### ■ Do not connect relays, switches or other devices to the output of this sensor in parallel at the PLC. Do not short-circuit the PLC input terminal connected to this sensor and (-) side of power to test input devices, neither, or the output circuit of this unit could be damaged.



### ■ When unit is changed

- If the product for domestic market is used with unit change function, and if unit other than MPa and kPa is used, put the unit label enclosed with the product on the unit display section in the control.

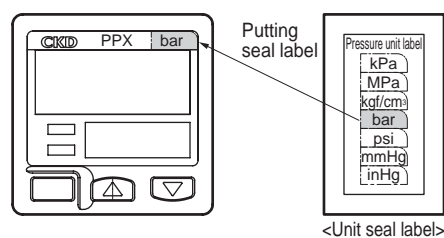

## During Use & Maintenance

### ⚠ WARNING

#### ■ Do not apply overcurrent.

- Due to short-circuit of load, if overcurrent applies to the pressure switch, the switch could be damaged or ignite. Install a fuse on output or power line as a overcurrent protective circuit.

### ⚠ CAUTION

#### ■ Do not disassemble the product.

- Disassembling the product could result in damage or deterioration of the product. CKD will not guarantee the performance after disassembling. When replacing or moving the product, remove the sensor without disassembling pressurized port.

#### ■ Stop machinery and equipment, then check the safety before operating the product.

#### ■ The case is made of resin. Do not use solvent, alcohol or any other cleaning agent, etc., to remove contamination, etc., or resin could be corroded or damaged. Wipe contaminations with a well wrung rag, etc., after soaked in weakened neutral detergent.

#### ■ Care must be taken for disconnection and reverse current caused by wiring resistance. When components including pressure switches are connected to the same power source of pressure switch, if (-) sides of output and power lines are short-circuited to check input devices of the control panel, or if (-) side of power line is disconnected, reverse current may apply to the output circuit of pressure switch, causing damages.

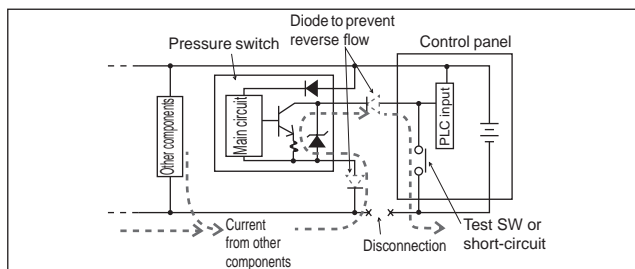

#### Take countermeasures as followings to prevent damages caused by reverse current.

- ① Do not concentrate current to the power line, especially, (-) side power line, and use wire as fat as possible.
- ② Limit numbers of components connected to the same power source of pressure switch.
- ③ Connect a diode in series to the pressure switch output line to prevent reverse current.
- ④ Connect a diode in series to power line (-) side of the pressure switch to prevent reverse current.

#### ■ Care must be taken for surge current leading.

When the power is shared with inductive loads that create surge current such as pressure switches, solenoid valves or relays, if the circuit is closed with inductive loads activated, surge current could lead to the output circuit, causing damages.

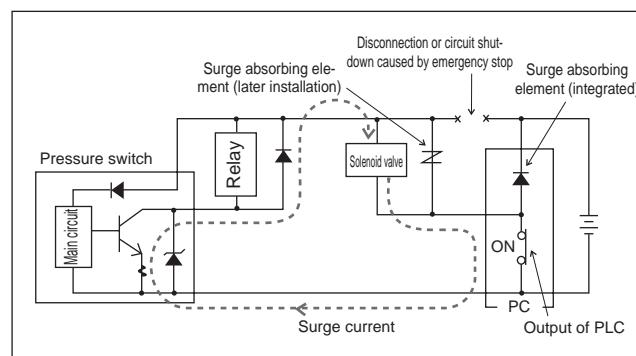

#### Take countermeasures as followings to prevent damage caused by surge current leading.

- ① Separate outputs creating inductive load such as solenoid valve and relay, etc. and power of inputs such as pressure switch, etc.
- ② If the power can not be separated from the inductive load, install a surge suppressor per load. The surge suppressor connected to PLC, etc. merely protects the unit connected.
- ③ Connect surge suppressors to the points as following to reduce damages when lines are disconnected.

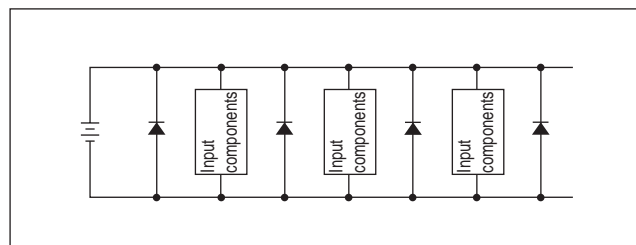

When components are connected with connectors, if a connector is dislocated during energizing, the output device could be damaged because of the reason above. Turn off the power before dislocating a connector.



# Digital pressure sensor PPX Series

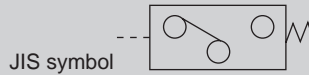

## Specifications

Descriptions	Standard type		High-function type	
	Low pressure PPX-R01*	High pressure PPX-R10*	Low pressure PPX-R01*H	High pressure PPX-R10*H
Pressure sensitive element	Diffused semiconductor pressure sensor			
Working fluid	Air/non-corrosive gas			
Type of pressure	Gauge pressure			
Rated pressure range Note 1	-100.0 to +100.0kPa	-0.100 to +1.000MPa	-100.0 to +100.0kPa	-0.100 to +1.000MPa
Set pressure range	-100.0 to +100.0kPa	-0.100 to +1.000MPa	-100.0 to +100.0kPa	-0.100 to +1.000MPa
Display unit	kPa	MPa	kPa	MPa
Minimum display unit	0.1kPa	0.001MPa	0.1kPa	0.001MPa
Unit change	Only available for domestic market (-KA) (MPa, kPa, kgf/cm <sup>2</sup> , bar, psi, mmHg, inchHg)			
Withstanding pressure	500kPa	1.5MPa	500kPa	1.5MPa
Repeatability	±0.1%F.S. (within ±2 digits)	±0.2%F.S. (within ±2 digits)	±0.1%F.S. (within ±2 digits)	±0.2%F.S. (within ±2 digits)
Temperature characteristics (+20 °C reference)	Within ±0.5%F.S.	Within ±1%F.S.	Within ±0.5%F.S.	Within ±1%F.S.
Indicator	4 + 4 digit 3 color LCD display (display update cycle: 250ms and 1000ms, select with key operation.)			
Indicator light	Orange LED (Comparison output 1 operational indicator light, comparison output 2 operational indicator light: comparison output ON lighting)		Orange LED (Comparison output 1 operational indicator light: comparison output ON lighting, analog voltage output operation display light: lighting during setting)	
Power voltage	12 to 24V DC±10% ripple P-P10% or less			
Power consumption	Normal: 840mW or less (current consumption 35mA or less at 24 V power) ECO MODE: 600mW or less at STD (current consumption 25mA or less at 24 V power) and 480mW or less at FULL (current consumption 20mA or less at 24 V power)			
Comparison output (switch output) Note 1	<NPN output type> NPN transistor and open collector • Max. inrush current: 100mA • Impress voltage: 30V DC or less (between comparison output and 0V) • Residual voltage: 2V or less (at inrush current 100mA)		<PNP output type> PNP transistor and open collector • Max. output current: 100mA • Impress voltage: 30V DC or less (between comparison output and +V) • Residual voltage: 2V or less (at output current 100mA)	
	Output operation	Select NO/NC with the key operation.		
	Output mode	EASY MODE/HYSTERESIS MODE/WINDOW COMPARATOR MODE		
	Hysteresis (hysteresis)	Min. 1 digit (variable)		
	Response time	2.5ms, 5ms, 10ms, 25ms, 50ms, 100ms, 250ms, 500ms, 1000ms and 5000ms, select with key operation.		
	Short circuit protection	Equipment		
External input (Auto-reference/remote zero adjusting)	—		<NPN output type> ON voltage: 0.4V DC or less OFF voltage: 5 to 30V DC or release Input impedance: 10kΩ Input time: 1ms and over	<PNP output type> ON voltage: 5V to +V DC OFF voltage: 0.6V DC or less or release Input impedance: 10kΩ Input time: 1ms and over
Analog output	—		Output voltage: 1 to 5V Zero point: Within 3V±5%F.S. Span: Within 4V±5%F.S. Linearity: Within ±1%F.S. Output impedance: 1kΩ	Output voltage: 0.6 to 5V Zero point: Within 1V±5%F.S. Span: Within 4.4V±5%F.S. Linearity: Within ±1%F.S. Output impedance: 1kΩ
Environment conditions	Protective structure	IP40 (IEC)		
	Ambient temperature	-10 to +50°C or to store: -10 to +60°C		
	Ambient humidity	35 to 85%RH (to be no dew condensation and unfrozen.) or to store: 35 to 85%RH		
	Withstanding voltage	1000V AC for one minute applied to all charged sections and between cases		
	Insulation resistance	50MΩ and over with 500 V DC mega applied to all charged sections and between cases		
	Mechanical vibration proof	Endurance 10 to 500Hz, compound amplitude 3mm, 2 hours to each XYZ direction (to mount on panel: endurance 10 to 150Hz, compound amplitude 0.75mm, 2 hours to each XYZ direction)		
	Mechanical shock proof	Endurance 100m/S <sup>2</sup> (10 G), 3 times to each XYZ direction		
Connection	Connector			
Port size Note 1	M5 female thread +R (PT) 1/8 male thread			
Wire length	Available up to 100m (less than 10m when CE marking complied) with cable not less than 0.3mm <sup>2</sup> when wiring is extended.			
Weight	Product weight: 40g, weight including package: 135g			
Accessory Note 2	PPX-C2 (2m cable with connector): 1 pcs. Unit seal label (for -KA with unit change): MPa, kPa, kgf/cm <sup>2</sup> , bar, psi, mmHg, inchHg			

Note 1: Refer to <table 1> on the following page for the products for the foreign markets.

Note 2: Cable with connector is not included for (-J).

### How to order

<How to order for domestic market>

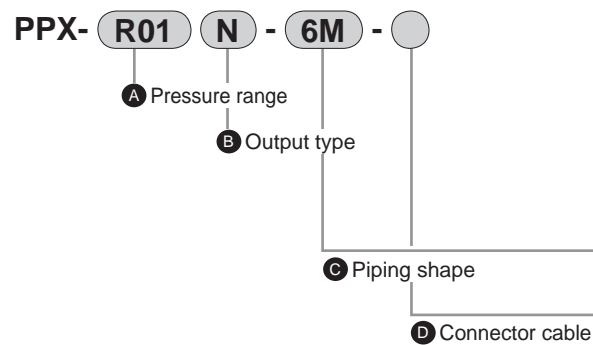

Symbol	Descriptions
<b>A Pressure range</b>	
R01	-100.0 to 100.0kPa
R10	-0.100 to 1.000MPa
<b>B Output type</b>	
N	NPN transistor output 2 point (standard type)
P	PNP transistor output 2 point (standard type)
NH	NPN transistor output 1 point + analog voltage output or external input (high-function type)
PH	PNP transistor output 1 point + analog voltage output or external input (high-function type)
<b>C Piping shape</b>	
6M	R1/8, M5
<b>D Connector cable</b>	
Blank	With connector cable
J Note 1	Without connector cable

Note 1: It is available only if B output type "N" or "P" is selected.

<How to order for foreign markets>

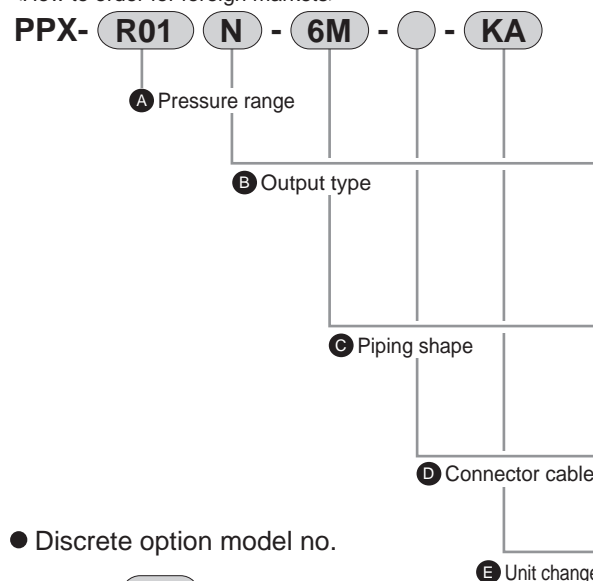

With the new Measurement Law, the product with the unit change function for foreign markets can not be used in Japan.

Symbol	Descriptions
<b>A Pressure range</b>	
R01	-100.0 to 100.0kPa
R10	-0.100 to 1.000MPa
<b>B Output type</b>	
N	NPN transistor output 2 point (standard type)
P	PNP transistor output 2 point (standard type)
NH	NPN transistor output 1 point + analog voltage output or external input (high-function type)
PH	PNP transistor output 1 point + analog voltage output or external input (high-function type)
<b>C Piping shape</b>	
6M Note 1	R1/8, M5
6N	NPT1/8, M5
6G Note 2	G1/8, M5
<b>D Connector cable</b>	
Blank	With connector cable
J Note 3	Without connector cable
<b>E Unit change</b>	
KA	With unit change function

Note 1: B output type "N" or "NH" is only available.

Note 2: B output type "P" or "PH" is only available.

Note 3: It is available only if B output type "N" or "P" is selected.

● Discrete option model no.

PPX- **C1**

Symbol	Descriptions
C1	Cable with connector 1m
C2	Cable with connector 2m
C3	Cable with connector 3m
C5	Cable with connector 5m
CN	Connector set (10 pcs. per set)
KL	Bracket (set screw attached)
KHS	Panel bracket
KCB	Front protective cover (when panel bracket used)

Destination	Switch output		Unit	Unit change	Unit seal label to be attached Note 1	Piping port
	NPN	PNP				
Domestic	○	○	kPa/MPa	–	–	R1/8(M5)
Asia	○	–	kPa/MPa	○	○	R1/8(M5)
Europe	–	○	kPa/MPa	○	○	G1/8(M5)
North America	○	○	kPa/MPa	○	○	NPT1/8(M5)

Note 1: Refer to Intro 6 for the unit seal label to be attached.

<Table 1>

Type	Model no.	Port size	Output type	Remarks
Standard type	PPX-R01N-6M-(J)-KA	M5 female thread +R (PT) 1/8 male thread	NPN transistor and open collector	For Asia
	PPX-R10N-6M-(J)-KA			
High-function type	PPX-R01NH-6M-KA			
	PPX-R10NH-6M-KA			
Standard type	PPX-R01P-6G-(J)-KA	M5 female thread +G1/8 male thread	PNP transistor and open collector	For Europe
	PPX-R10P-6G-(J)-KA			
High-function type	PPX-R01PH-6G-KA			
	PPX-R10PH-6G-KA			
Standard type	PPX-R01N-6N-(J)-KA	M5 female thread +NPT1/8 male thread	NPN transistor and open collector	For North America
	PPX-R01P-6N-(J)-KA		PNP transistor and open collector	
	PPX-R10N-6N-(J)-KA		NPN transistor and open collector	
	PPX-R10P-6N-(J)-KA		PNP transistor and open collector	
High-function type	PPX-R01NH-6N-KA		NPN transistor and open collector	
	PPX-R01PH-6N-KA		PNP transistor and open collector	
	PPX-R10NH-6N-KA		NPN transistor and open collector	
	PPX-R10PH-6N-KA		PNP transistor and open collector	

## Analog output voltage - pressure characteristics

● PPX-R01NH  
R01PH

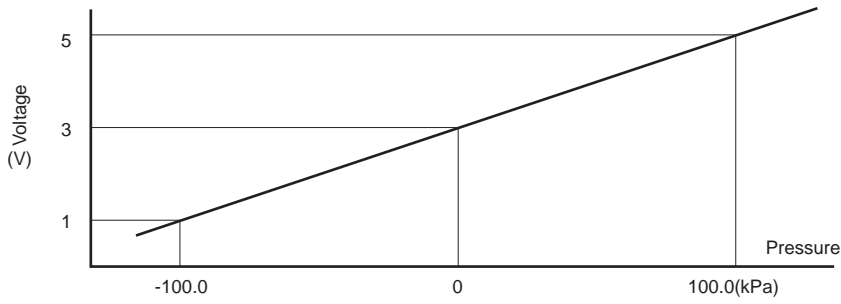

● PPX-R10NH  
R10PH

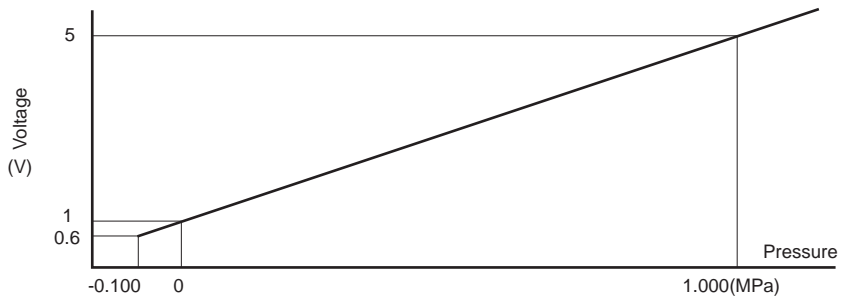

Dimensions

● PPX-R\*\*-6M/6N (R/NPT thread)

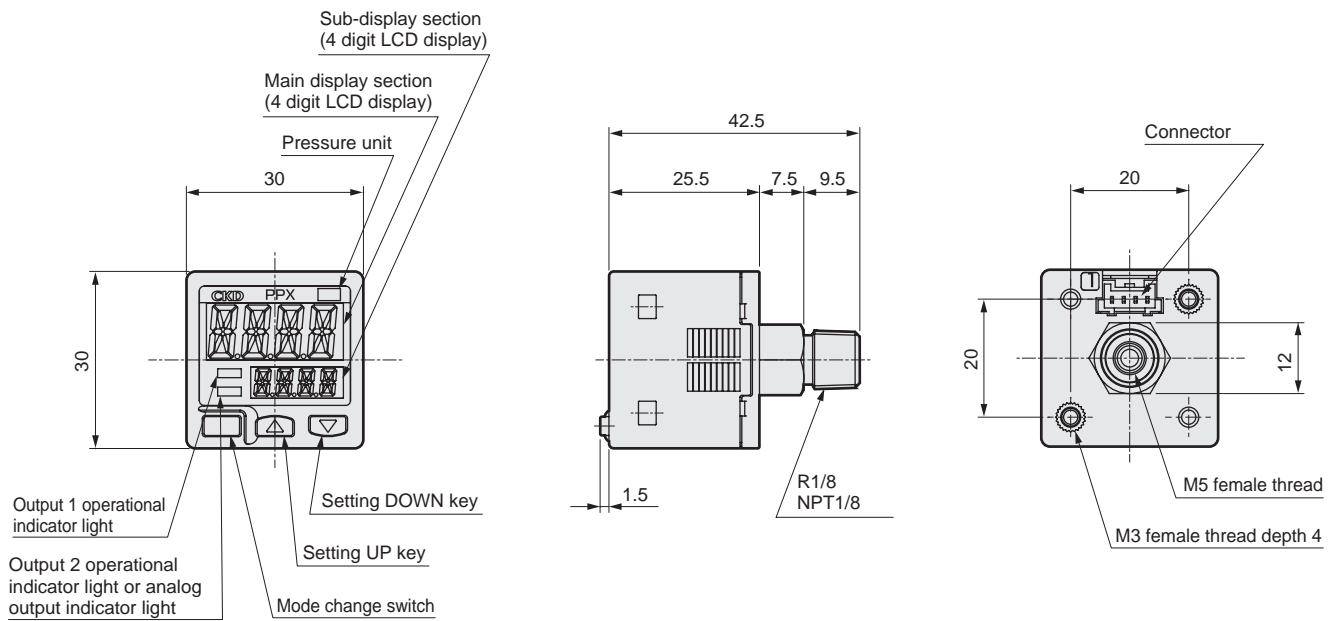

● PPX-R\*\*-6G (G thread)

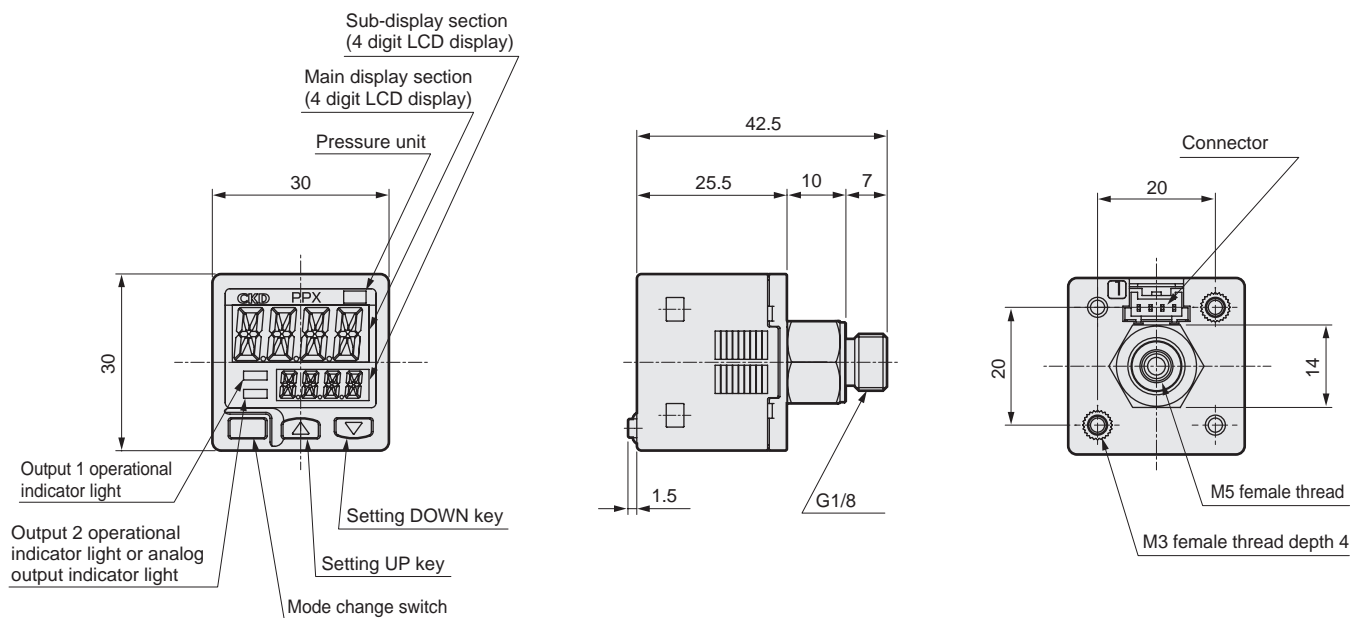

## Dimensions with options

### ● Bracket (PPX-KL)

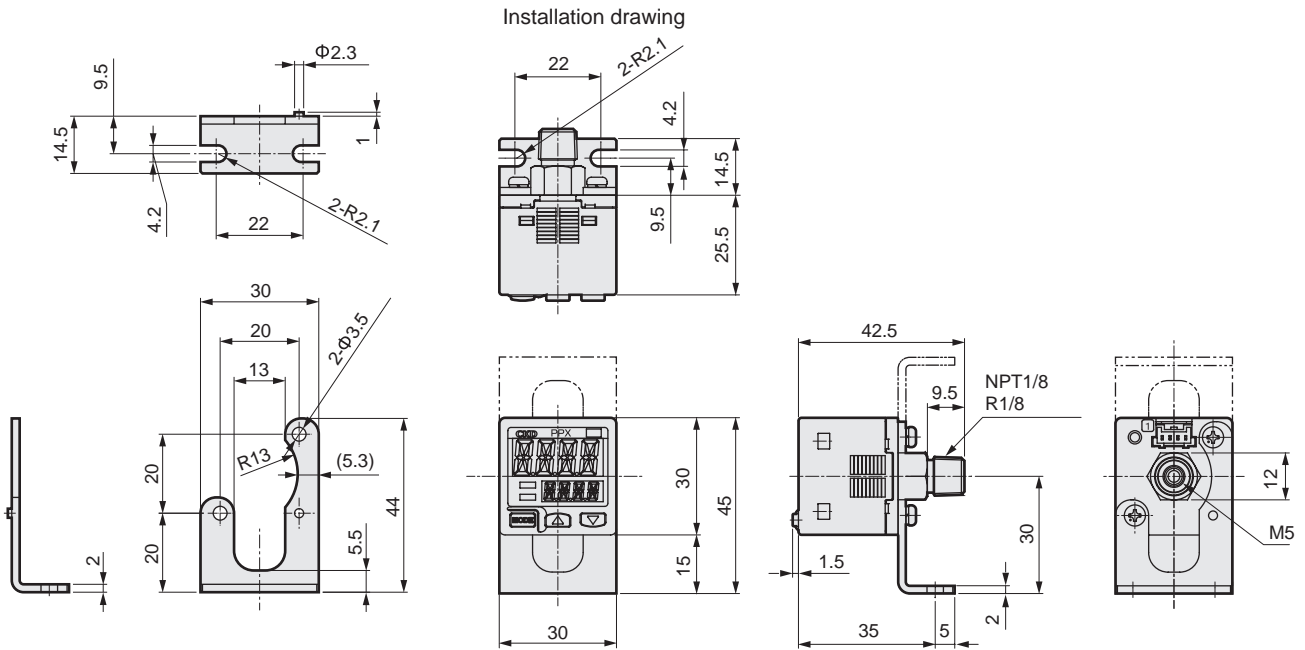

### ● Panel bracket (PPX-KHS) installation drawing

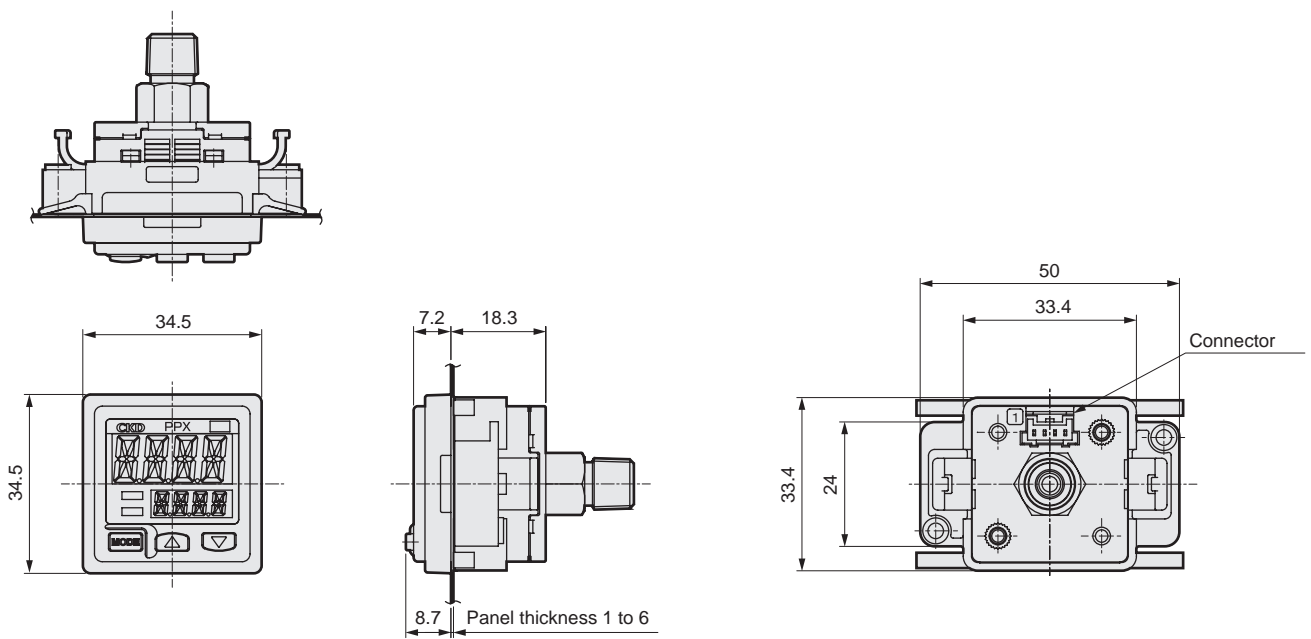

## Panel cut dimensions

Installing 1 pc.

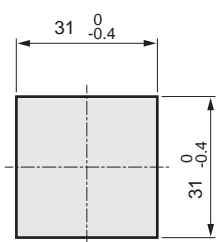

Installing consecutive n pcs. horizontally.

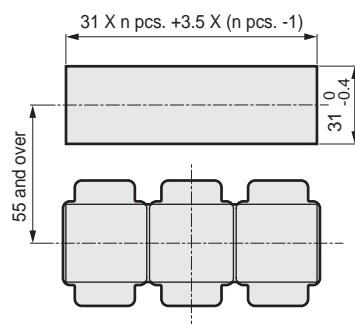

(Note 1): Panel thickness must be 0.5 to 6mm.

Installing consecutive n pcs. vertically.

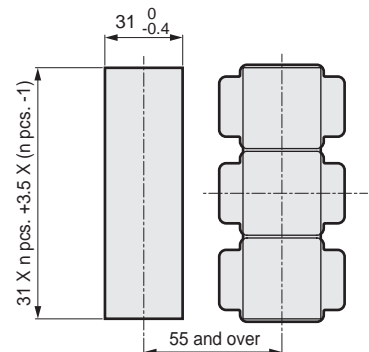

(Note 1): Panel thickness must be 0.5 to 6mm.

### Dimensions with options

● Front protective cover (PPX-KCB) installation drawing

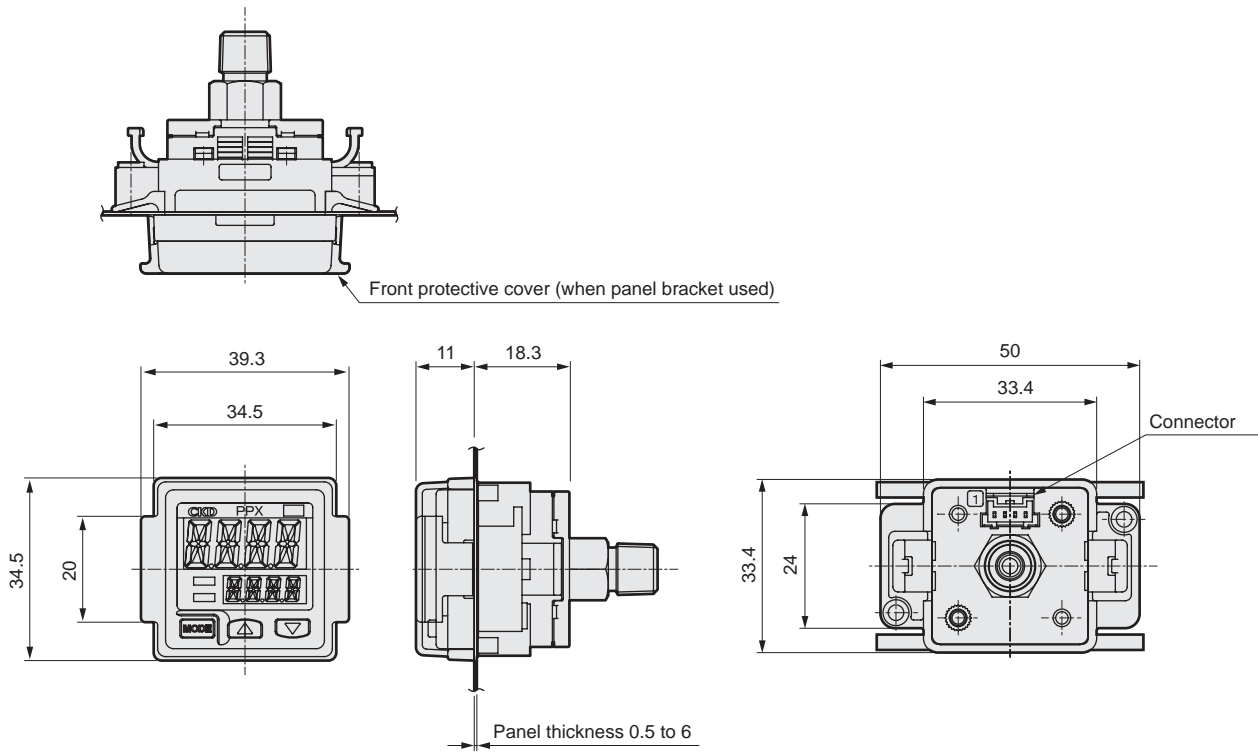

● Cable with connector (PPX-C\*)

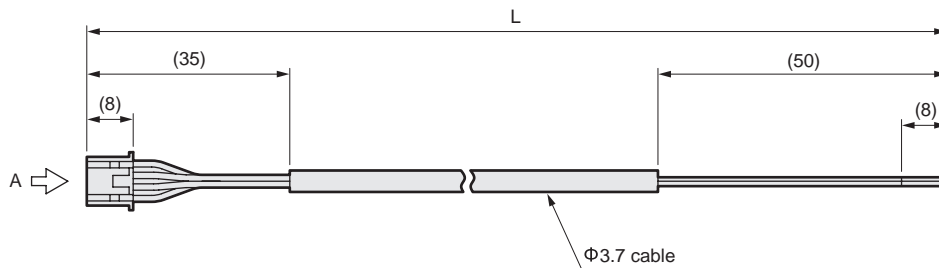

(JST MFG CO. LTD.)

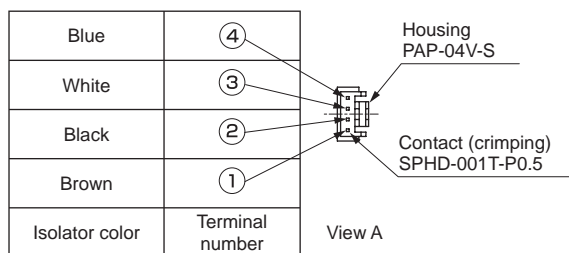

Model no.	Cable length
PPX-C1	1m
PPX-C2	2m
PPX-C3	3m
PPX-C5	5m

● Connector set (PPX-CN)

- Housing: JST MFG CO. LTD. PAP-04V-S
- Contact: JST MFG CO. LTD. SPHD-001T-P0.5

## Circuit and connection methods

### NPN output type

#### ● Standard type

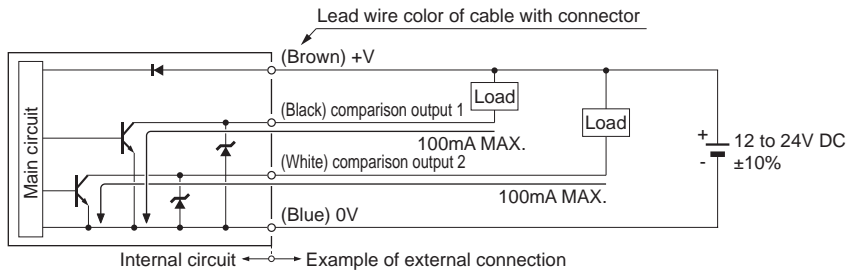

#### ● Leakage inspection (high-function type)

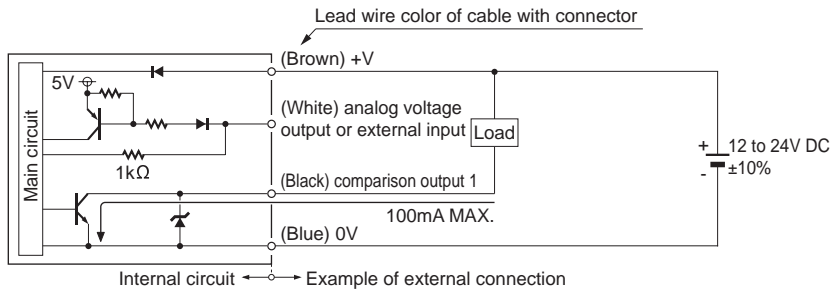

#### <Example of external input connection>

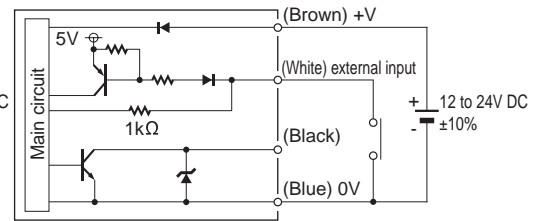

### PNP output type

#### ● Standard type

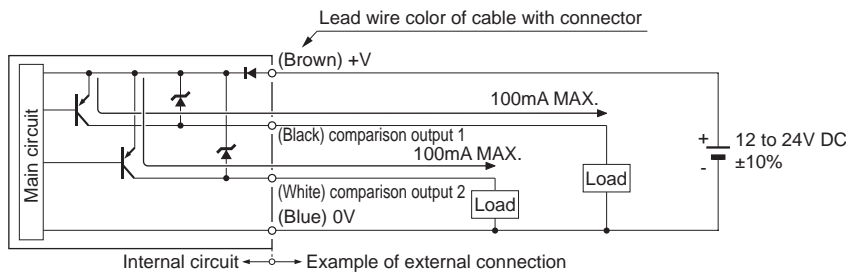

#### ● Leakage inspection (high-function type)

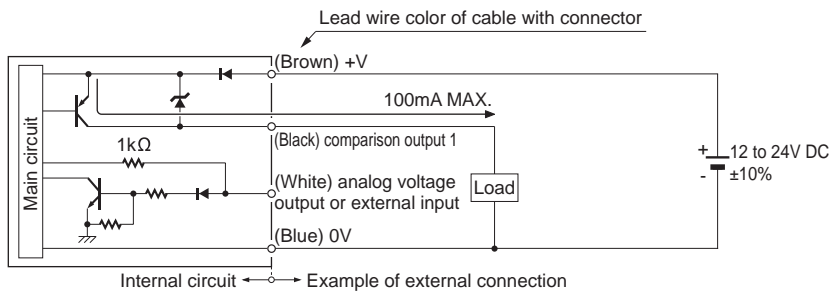

#### <Example of external input connection>

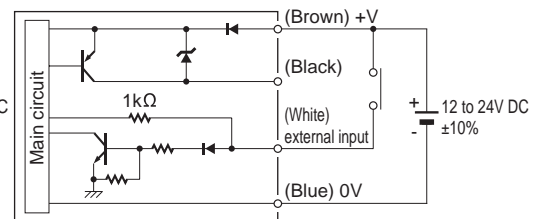



---

MEMO

---

## Name of display and controls

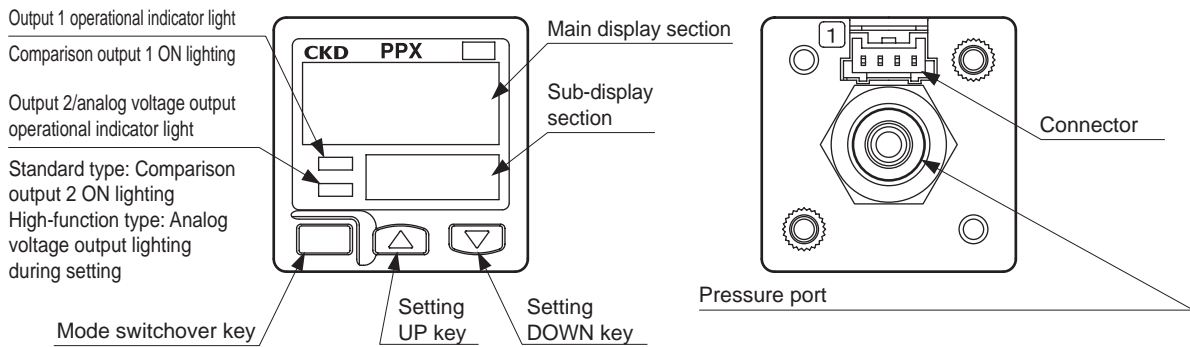

## Output mode and output operation

- The output mode for comparison output 1 and comparison output 2 can be selected from EASY MODE, HYSTERESIS MODE and WINDOW COMPARATOR MODE. Refer to "Comparison output 1/2 output mode setting" in the menu setting mode section on page 12 for the details.

### EASY MODE

- This mode controls ON/OFF of comparison output.

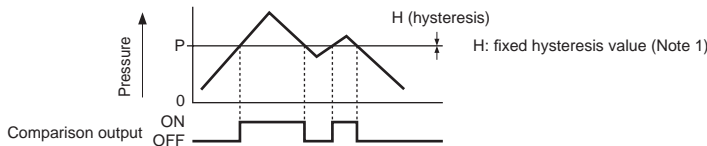

(Note 1): Hysteresis varies with 8 steps.

Refer to "Switching fixed hysteresis value" in "PRO MODE" on page 13 for the setting method.

(Note 2): " $P-1$ " is displayed in the sub-display section for comparison output 1, while " $P-2$ " for comparison output 2.

### Hysteresis mode

- This mode controls ON/OFF of comparison output with setting hysteresis randomly.

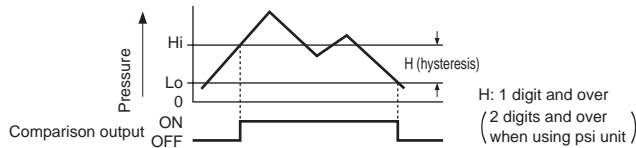

(Note 1): " $H_1-1$ " and " $L_0-1$ " are displayed in the sub-display section for comparison output 1, while " $H_1-2$ " and " $L_0-2$ " for comparison output 2.

### WINDOW COMPARATOR MODE

- This mode controls ON or OFF of comparison output within set pressure range.

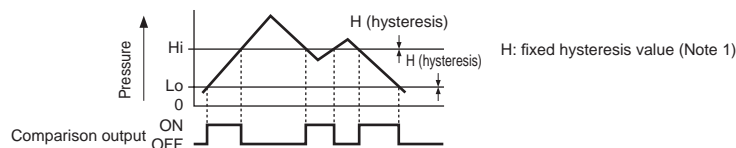

(Note 1): Hysteresis varies with 8 steps.

Refer to "Switching fixed hysteresis value" in "PRO MODE" section on page 13 for the setting method.

(Note 2): " $H_1-1$ " and " $L_0-1$ " are displayed in the sub-display section for comparison output 1, while " $H_1-2$ " and " $L_0-2$ " for comparison output 2.

## Setting

### <Installation procedure>

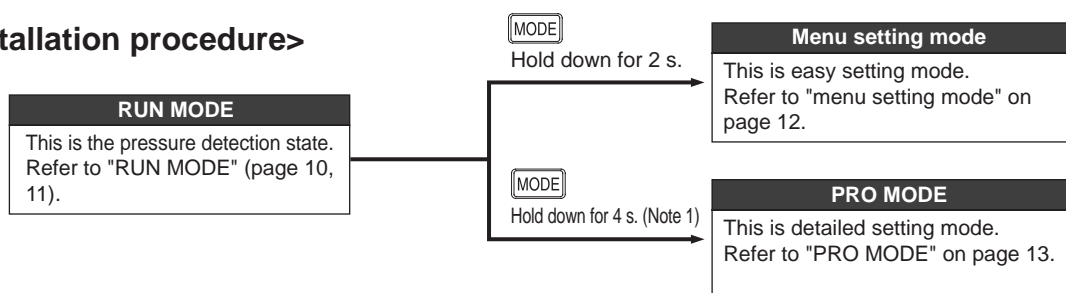

(Note 1): The mode is switched to menu setting mode in 2 seconds after pressing the mode switchover key, however, keep it press down.

## RUN MODE

### Threshold value setting

- Refer to <setting comparison output 1/2 output mode> and <switching analog voltage output/external input> in the "menu setting mode" on page 12 for the setting conditions.

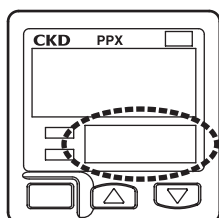

The sub-display section display is only switched when setting the threshold value, so the following diagram shows only sub-display section.

(Note 1): If set pressure range is overflowed, "UP" (upper limit over) or "DOWN" (lower limit over) is displayed in the sub-display section. When setting threshold value in "hysteresis mode/window comparator mode", if Hi side threshold value is smaller than Lo side threshold value, "DOWN" is displayed.

### <For standard type>

#### <Setting conditions ①>

Comparison output 1 output mode: "EASY" (EASY MODE)  
Comparison output 2 output mode: "OFF" (OFF)

#### <RUN MODE state>



#### <Setting conditions ②>

Comparison output 1 output mode: "EASY" (EASY MODE)  
Comparison output 2 output mode: "EASY" (EASY MODE)

#### <RUN MODE state>

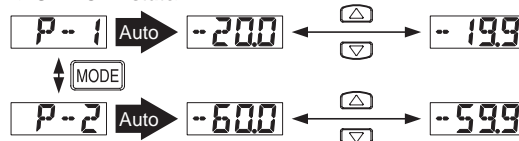

#### <Setting conditions ③>

Comparison output 1 output mode: "EASY" (EASY MODE)  
Comparison output 2 output mode: "HYS" (hysteresis mode) or "WCOMP" (window comparator mode)

#### <RUN MODE state>

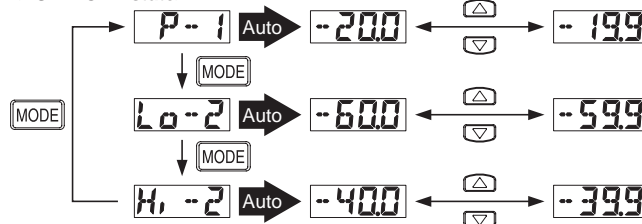

#### <Setting conditions ④>

Comparison output 1 output mode: "HYS" (hysteresis mode) or "WCOMP" (window comparator mode)  
Comparison output 2 output mode: "OFF" (OFF)

#### <RUN MODE state>

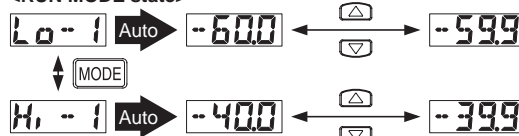

<Setting conditions ⑤>

Comparison output 1 output mode: "HYS" (hysteresis mode) or "WCOMP" (window comparator mode)  
 Comparison output 2 output mode: "EASY" (EASY MODE)

<Setting conditions ⑥>

Comparison output 1 output mode: "HYS" (hysteresis mode) or "WCOMP" (window comparator mode)  
 Comparison output 2 output mode: "HYS" (hysteresis mode) or "WCOMP" (window comparator mode)

<RUN MODE state>

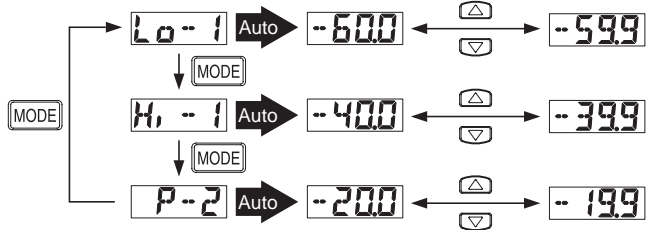

<RUN MODE state>

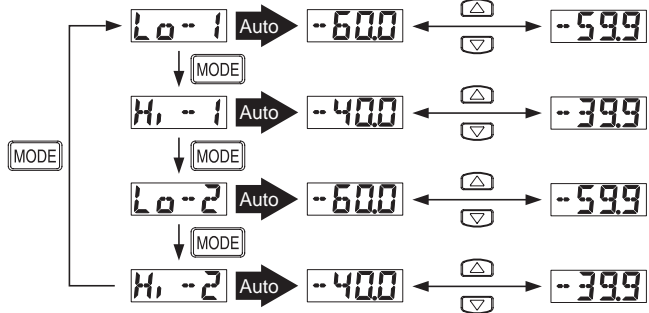

## <For high-function type>

<Setting conditions ⑦>

Comparison output 1 output mode: "EASY" (EASY MODE)  
 Analog voltage output/external input switching: "ROUT" (analog voltage output)

<Setting conditions ⑧>

Comparison output 1 output mode: "EASY" (EASY MODE)  
 Analog voltage output/external input switching: "AREF" (auto-reference input) or "ZERO" (remote zero adjusting input)

<Setting conditions ⑨>

Comparison output 1 output mode: "HYS" (hysteresis mode) or "WCOMP" (window comparator mode)  
 Analog voltage output/external input switching: "ROUT" (analog voltage output)

<Setting conditions ⑩>

Comparison output 1 output mode: "HYS" (hysteresis mode) or "WCOMP" (window comparator mode)  
 Analog voltage output/external input switching: "AREF" (auto-reference input) or "ZERO" (remote zero adjusting input)

<RUN MODE state>



<RUN MODE state>

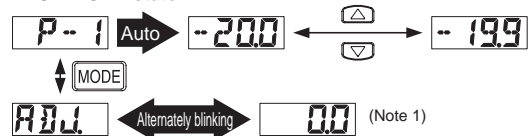

<RUN MODE state>

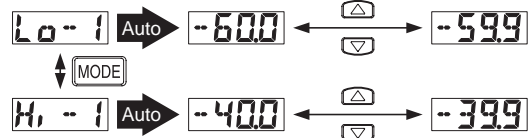

<RUN MODE state>

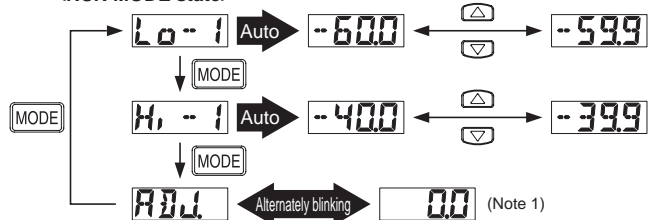

(Note 1): Auto-reference and remote zero adjusting values are displayed. Refer to "Auto-reference" section on page 15 and "Remote zero adjusting" section on page 16 for the details.

## <Common>

### Zero adjusting

- Zero adjusting is the function that pressure display is forcibly set to "zero" when the pressure port is released to atmospheric pressure.



### Key lock

- Key lock is the function that rejects key operation as the each setting mode is not changed incorrectly.

<Key lock setting>

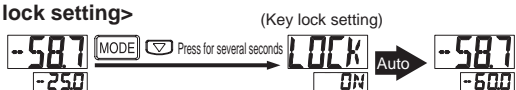

<Key lock release>

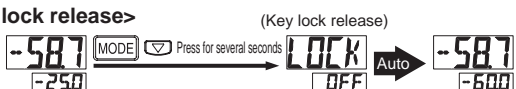

### Peak/bottom hold

- Peak/bottom hold is the function that displays peak and bottom values of fluctuated pressure.
- Peak value is displayed in the main display section, and bottom value is displayed in the sub-display section.

<Peak and bottom hold setting>



<Peak and bottom hold release>



## Menu setting mode

- If the mode switchover key is held down for 2 seconds during RUN MODE, the mode is switched to menu setting mode.
- Hold down the mode switchover key for several seconds during the setting to switch to RUN MODE. In that case, the changed descriptions are set.
- The state of left end display section is default.

### RUN MODE

↓ [MODE] Hold down for 2 s.

#### Comparison output 1 output mode setting

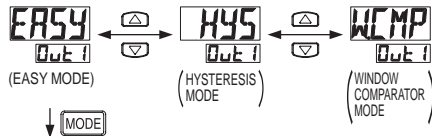

↓ [MODE]

<For standard type>

#### Comparison output 2 output mode setting (Note 1)

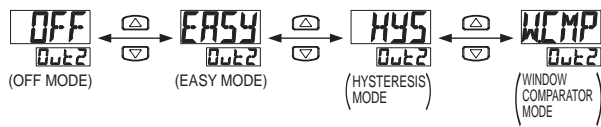

<For high-function type>

#### Analog voltage output/external input switching

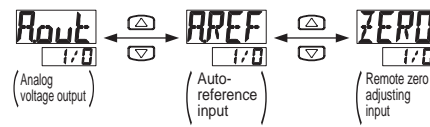

↓ [MODE]

<For standard type>

#### N.O./N.C. switching (Note 1) (Note 2)

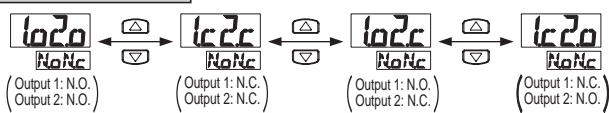

<For high-function type>

#### N.O./N.C. switching (Note 2)

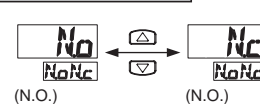

↓ [MODE]

#### Response time setting

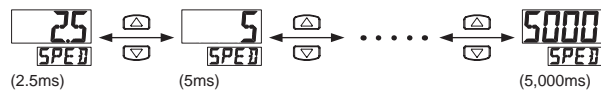

↓ [MODE]

#### Switching display color of main display section

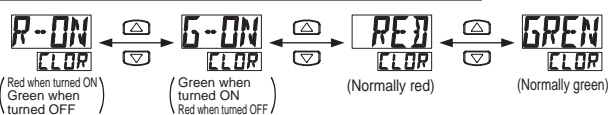

↓ [MODE]

#### Unit switching

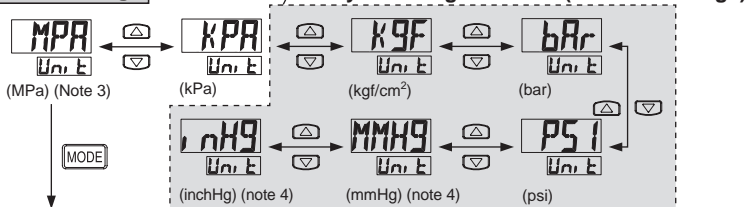

### RUN MODE

- (Note 1): The same display as high-function type applies to N.O./N.C. switching display if the comparison output 2 output mode setting is set to "OFF".
- (Note 2): Default of high pressure type is "No". Default of low pressure type is "Nc".
- (Note 3): Default of low pressure type is "kPa". "MPa" is not displayed.
- (Note 4): High pressure type does not display this unit.

Setting descriptions	Descriptions
Comparison output 1 output mode setting	Output mode of comparison output 1 is set.
Comparison output 2 output mode setting (Only standard)	Output mode of comparison output 2 is set.
Switching analog voltage output/external input (Only high-function type)	Analog voltage output, auto-reference input or remote zero adjusting input switching can be selected.
N.O./N.C. switching	Normally open (N.O.) or normally closed (N.C.) can be set. Response time is set.
Response time setting	Response time can be selected from 2.5ms, 5ms, 10ms, 25ms, 50ms, 100ms, 250ms, 500ms, 1,000ms and 5,000ms.
Switching display color of main display section	Display color of main display section can be switched.
Unit switching	Pressure unit can be switched.

## PRO MODE

- The mode will be switched to PRO MODE if the mode switchover key is held down for 4 seconds during RUN MODE.
- Hold down the mode switchover key for several seconds during the setting to switch to RUN MODE. In that case, the changed descriptions are set.
- The left end display section is default.

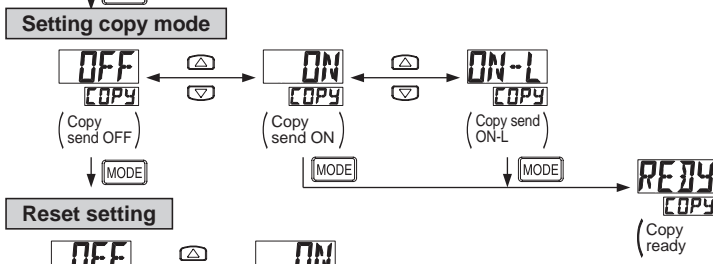
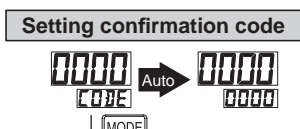
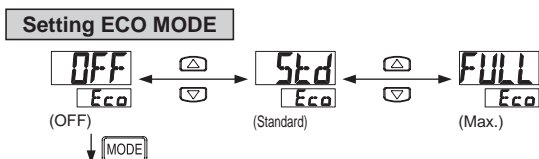
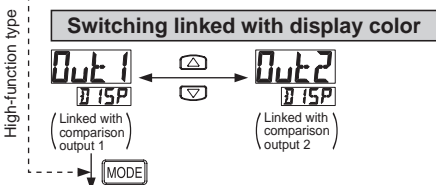
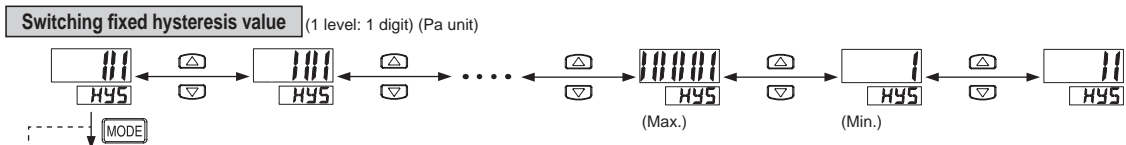
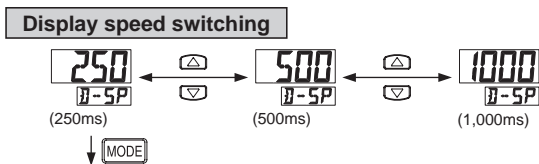
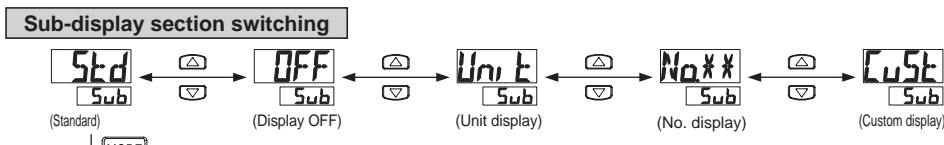
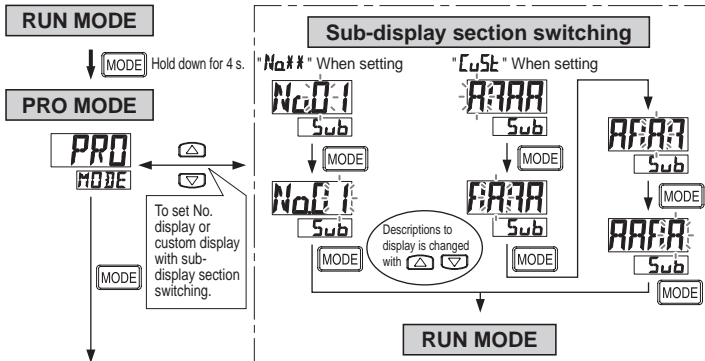

**RUN MODE**

Setting descriptions	Descriptions
Sub-display section switching	Sub-display section display during RUN MODE is switched. "OFF": Nothing is displayed. "Unit": The current pressure unit is displayed. "No.#": Specified number is displayed. "Unit": Specified number, character (some characters can not be displayed) or symbol is displayed.
Display speed switching	Display speed of pressure displayed in the main display section is switched.
Fixed hysteresis value switching	Hysteresis of EASY MODE and WINDOW COMPARATOR MODE is set. (8 steps)
Switching display color (Only standard)	The descriptions set with main display section display color switching in the menu setting mode are compared. Interlock with either output 1 or comparison output 2 can be switched.
Setting ECO MODE	Power consumption can be reduced. "OFF": Normally (ECO MODE OFF) "Std": Display section gets dark if the key operation is not done for 5 seconds in RUN MODE. "Full": Display section is turned OFF if the key operation is not done for 5 seconds in RUN MODE. Hold down any key to display normal state temporarily.
Setting confirmation code	The current setting details can be checked. Refer to the code list for codes.
Setting copy mode	A copy of master side sensor setting details can be made to a slave side sensor. Refer to "Setting copy function" section on page 15 for the details. "ON": A copy of setting details is sent. "ON-L": A copy of setting details is sent, then key lock applies to the slave side sensor.
Reset setting	Default setting applies.

### Code list

Code	1st digit		2nd digit			3rd digit	4th digit	
	Comparison output 1 output mode	N.O./N.C. switching	Standard type		High-function type		Display color of main display section	Only standard
			Comparison output 2 output mode	N.O./N.C. switching	Analog voltage output/external input	Threshold value display		Display color interlock
0	EASY	N.O.	OFF	OFF	Analog voltage output	P-1, Lo-1	Red when	Comparison output 1
1		N.C.	EASY	N.O.	Auto-reference	Hi-1	turned ON	Comparison output 2
2	Hysteresis	N.O.		Hysteresis	N.C.	Remote zero adjusting	P-2, Lo-2	Green when
3		N.C.	N.O.		-	Hi-2	turned ON	Comparison output 2
4	Window comparator	N.O.	Window comparator	N.C.	-	ADJ.	Normally	Comparison output 1
5		N.C.		N.O.	-	-	red	Comparison output 2
6	-	-	-	N.C.	-	-	Normally	Comparison output 1
7	-	-	-	-	-	-	green	Comparison output 2

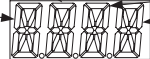

Code	5th digit	6th digit	7th digit	8th digit
	Response time	Unit switching	Display speed	ECO MODE
0	2.5ms	MPa	250ms	OFF
1	5ms	kPa	500ms	Std
2	10ms	kgf/cm <sup>2</sup>	1,000ms	Full
3	25ms	bar	-	-
4	50ms	psi	-	-
5	100ms	mmHg	-	-
6	250ms	inchHg	-	-
7	500ms	-	-	-
8	1,000ms	-	-	-
9	5,000ms	-	-	-

— Only for foreign markets (with unit change)

## Setting copy function

● This makes a copy of setting details to the slave side sensor from the master side sensor.

- A copy between different models can not be made.
- The setting copy function applies to one slave side sensor per master side sensor.

### <Installation procedure>

- ① Set setting copy mode of the master sensor as "sending ON" or "ON-L", then press the mode switch key to set ready state. Refer to "Setting copy mode" in the PRO MODE section on page 13 for details.
- ② Turn off the power of master side sensor.
- ③ Wire between master and slave sides as the following diagram.

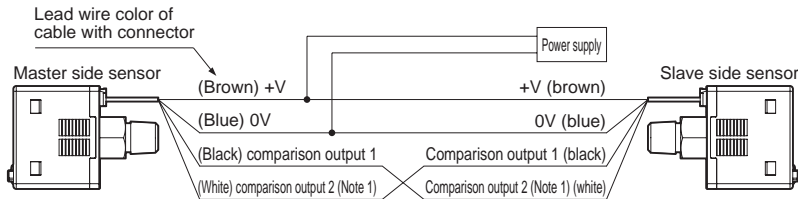

(Note 1): Analog voltage output/external input applies for high function type.

- ④ Turn the power of the master and slave side sensors ON at the same time. (Note 2) (Note 3)
  - ⑤ Setting details are 16-bit encoded, and displayed with orange characters in the main display section of the master side sensor, then a copy starts.
  - ⑥ The same codes as the procedures ⑤ are displayed with green characters in the main display section of the slave side sensor, and "OK" is displayed in the sub-display section. (A copy is completed).
  - ⑦ Turn off the power of the master and slave side sensors, then remove wiring.
- \* If a copy of setting details is repeatedly made to another sensor, follow procedures ③ to ⑥.

(Note 2): A copy of setting details could not be made if power is not turned on at the same time.

(Note 3): Pulse output is outputted from the comparison output 1 output, if power is turned on.

### <To reset the master side sensor setting copy mode.>

- ① Turn on power of a master side sensor (with wiring of slave side sensor removed).
- ② Hold down the mode switchover key for 2 seconds.

## Auto-reference (only high-function type)

- Auto-reference is the function that compensates the setting of detection pressure as the reference pressure when auto-reference input.
- Based on detection pressure P(a) when auto-reference input, the setting (1)' is automatically compensated to "setting (1)+P(a)".

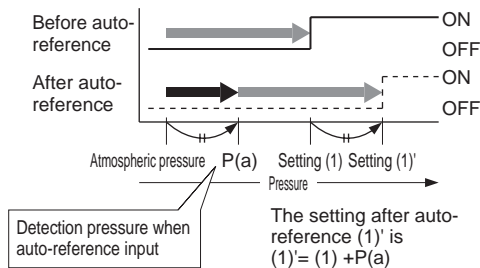

### Set range and set pressure range after compensation

● The set pressure range is wider than the rated pressure range in accordance with auto-reference.

If the compensated settings overflow set pressure range when auto-reference input, the setting is automatically compensated to set pressure range. Do not overflow set pressure range.



## Operation chart

<Normal (N.O. setting for each comparison output)>

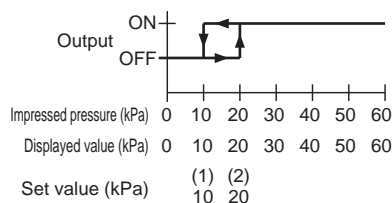

(Note 1): With EASY MODE and WINDOW COMPARATOR MODE, the setting is shifted in the same manner.

<<Auto-reference input (N.O. setting for each comparison output)>>

- Detection pressure when auto-reference input: 10kPa
- Output mode: Hysteresis mode

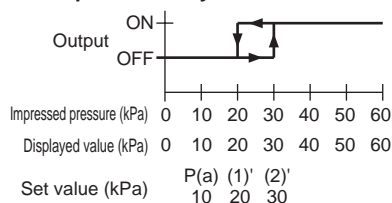

- Detection pressure is set to "zero", if the analog voltage output/external input switching setting is changed, or if power is turned ON again when auto-reference input.
- The auto-reference input can be checked when setting the threshold value in the RUN MODE. Refer to the threshold value setting on Page 12; RUN MODE for the details.

## Remote zero adjusting (only high-function type)

- Remote zero adjusting is the function that forcibly set the pressure at that time to "zero" with an external input signal.

The setting can not be compensated when remote zero adjusting input. Do not overflow set pressure range for the pressure and the setting during remote zero adjusting.

## Operation chart

<Normal (N.O. setting for each comparison output)>

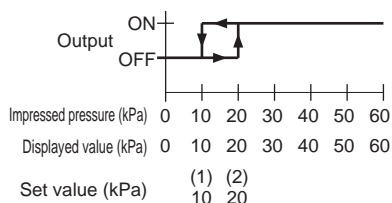

(Note 1): With EASY MODE and WINDOW COMPARATOR MODE, the setting is shifted in the same manner.

<<Remote zero adjusting input (N.O. setting for each comparison output)>>

- Pressure for remote zero adjusting input: 10kPa
- Output mode: Hysteresis mode

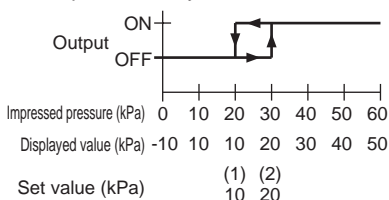

- With remote zero adjusting, if analog voltage output/external input setting is changed, or if the power is turned ON again, the remote zero adjusting value is made clear, going back to the normal operation with atmospheric pressure standard. Remote zero adjusting value can be checked when setting the threshold value in RUN MODE. Refer to the threshold value setting in "RUN MODE" section on Page 10 for the details.

## Error display

Error display	Descriptions	Measures
E-1	The load is short-circuited, and overcurrent flows.	Check a load after the power turned OFF.
E-3	Pressure is applied during zero point adjustment.	Apply atmospheric pressure to the pressure port, then execute zero adjustment again.
E-4	External input overflows the rated pressure range.	Reset applied pressure to the rated pressure range.
E-5	Communication error (disconnection or incorrect connection, etc.)	Check wiring before using the copy function.
E-6	Communication error (A different model is used.)	Check the configuration used with same models before using the copy function.
✕✕✕	Applied pressure reaches the upper limit of display pressure range.	Set applied pressure within rated pressure range.
-- ✕✕✕	Applied pressure reaches the lower limit (back pressure) of display pressure range.	

## Example of setting operation per application EASY MODE

(Note 1): This is the example of setting if operated from default setting (default).

(Note 2): If the setting conditions are unknown, operate <reset setting> in PRO MODE, and reset to default before using.

### ● Suction confirmation

To EASY MODE

R01 type (-100.0 to 100.0kPa)

- Start from the mode when power turned ON (RUN MODE).
- If RUN MODE is not selected, hold down the "MODE" key for several seconds to display the RUN MODE state.

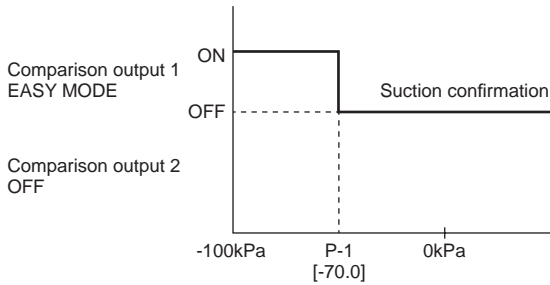

#### RUN MODE screen

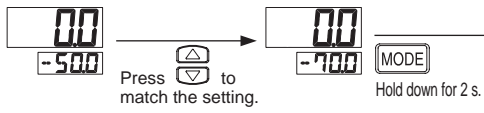

#### Menu setting mode screen

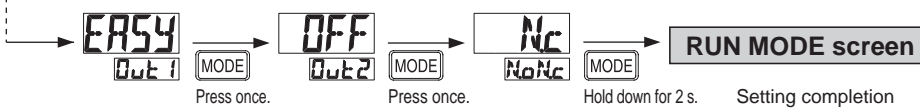

### ● Suction + vacuum break confirmation

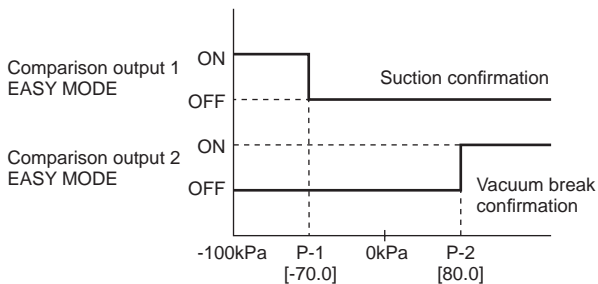

#### RUN MODE screen

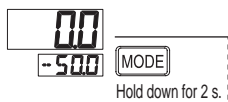

#### Menu setting mode screen



#### RUN MODE screen

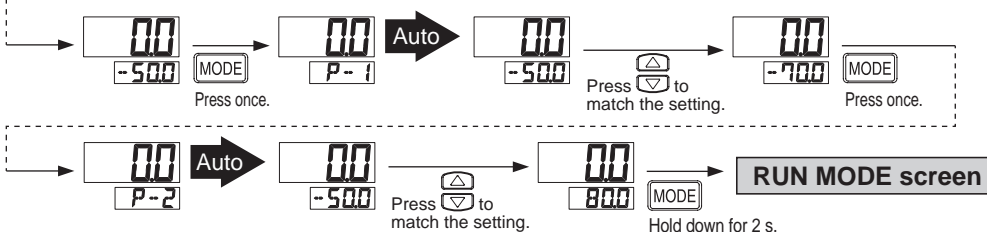

**Example of setting operation per application HYS MODE (hysteresis mode)**

(Note 1): This is an example of setting if operated from default setting.

(Note 2): If the setting conditions are unknown, operate <reset setting> in PRO MODE, and reset to default before using.

● Suction confirmation

To HYS MODE (hysteresis mode)  
R01 type (-100.0kPa to 100.0kPa)

- Start from the mode when power turned ON (RUN MODE).
- If RUN MODE is not selected, hold down the "MODE" key for several seconds to display the RUN MODE state.

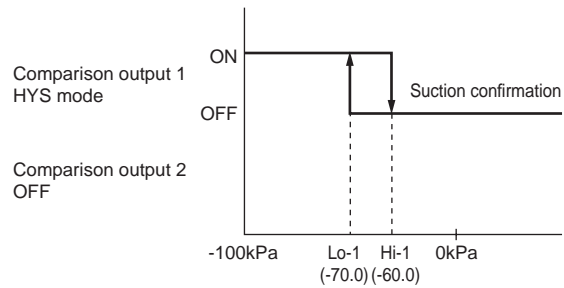

**RUN MODE screen**

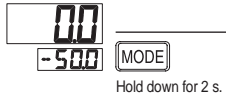

**Menu setting mode screen**

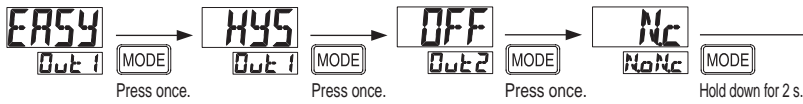

**RUN MODE screen**

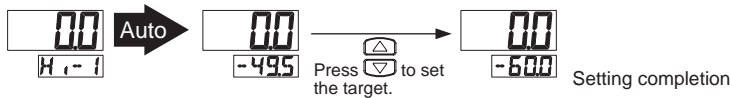
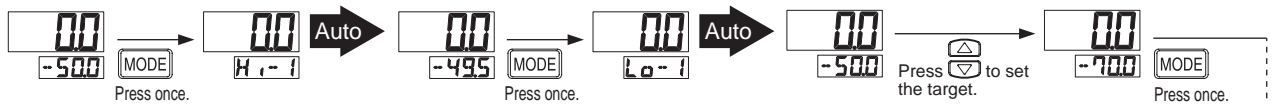

● Suction + vacuum break confirmation

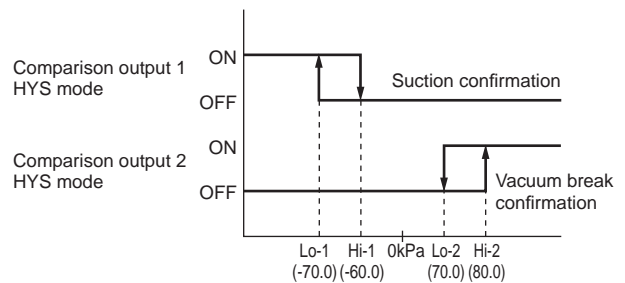

**RUN MODE screen**

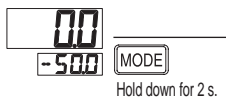

**Menu setting mode screen**

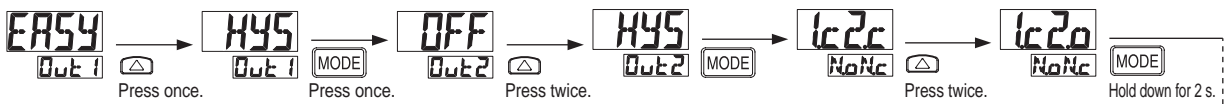

**RUN MODE screen**

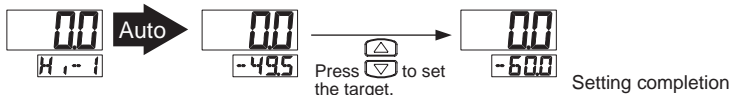
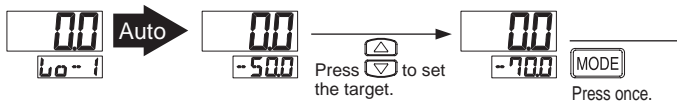
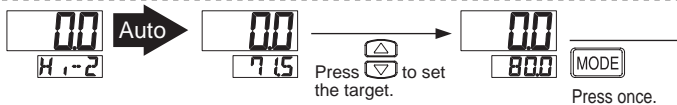
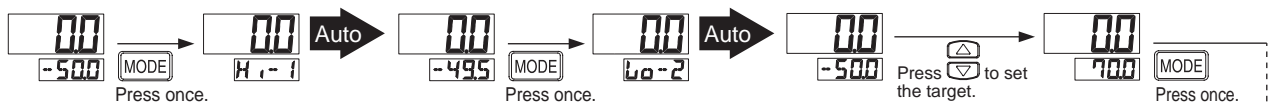

## Example of setting operation per application WCMP MODE (window comparator mode)

(Note 1): This is an example of setting if operated from default setting.

(Note 2): If the setting conditions are unknown, operate <reset setting> in PRO MODE, and reset to default before using.

### ● Source pressure confirmation

To WCMP MODE (window comparator mode)

R01 type (-0.100 to 1.000MPa)

- Start from the mode (RUN MODE) when power turned ON.
- If RUN MODE is not selected, hold down the "MODE" key for a while to enter RUN MODE.

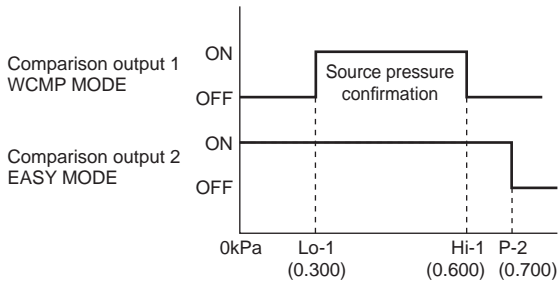

### RUN MODE screen

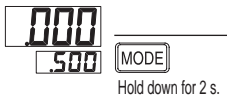

### Menu setting mode screen

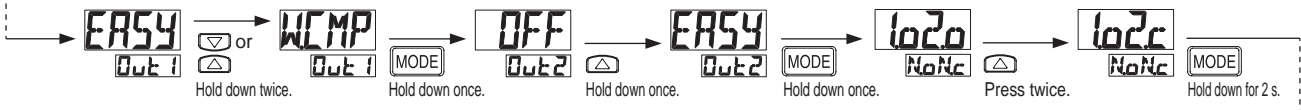

### RUN MODE screen

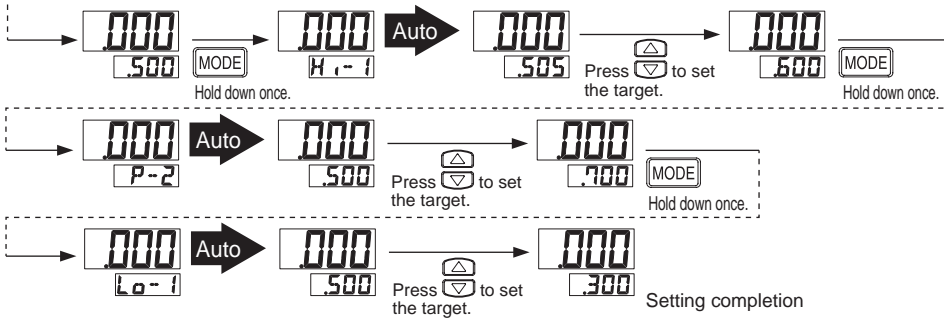

## Related products

### Precision regulator RP1000, RP2000 series

This is an appropriate regulator for applications such as tension control and balancers

- High accuracy pressure control
- Large relief flow
- Extremely low pressure setting possible (RP1000)
- Compact
- The long service life (RP2000)

Catalog No.CB-024SA





---

MEMO

---

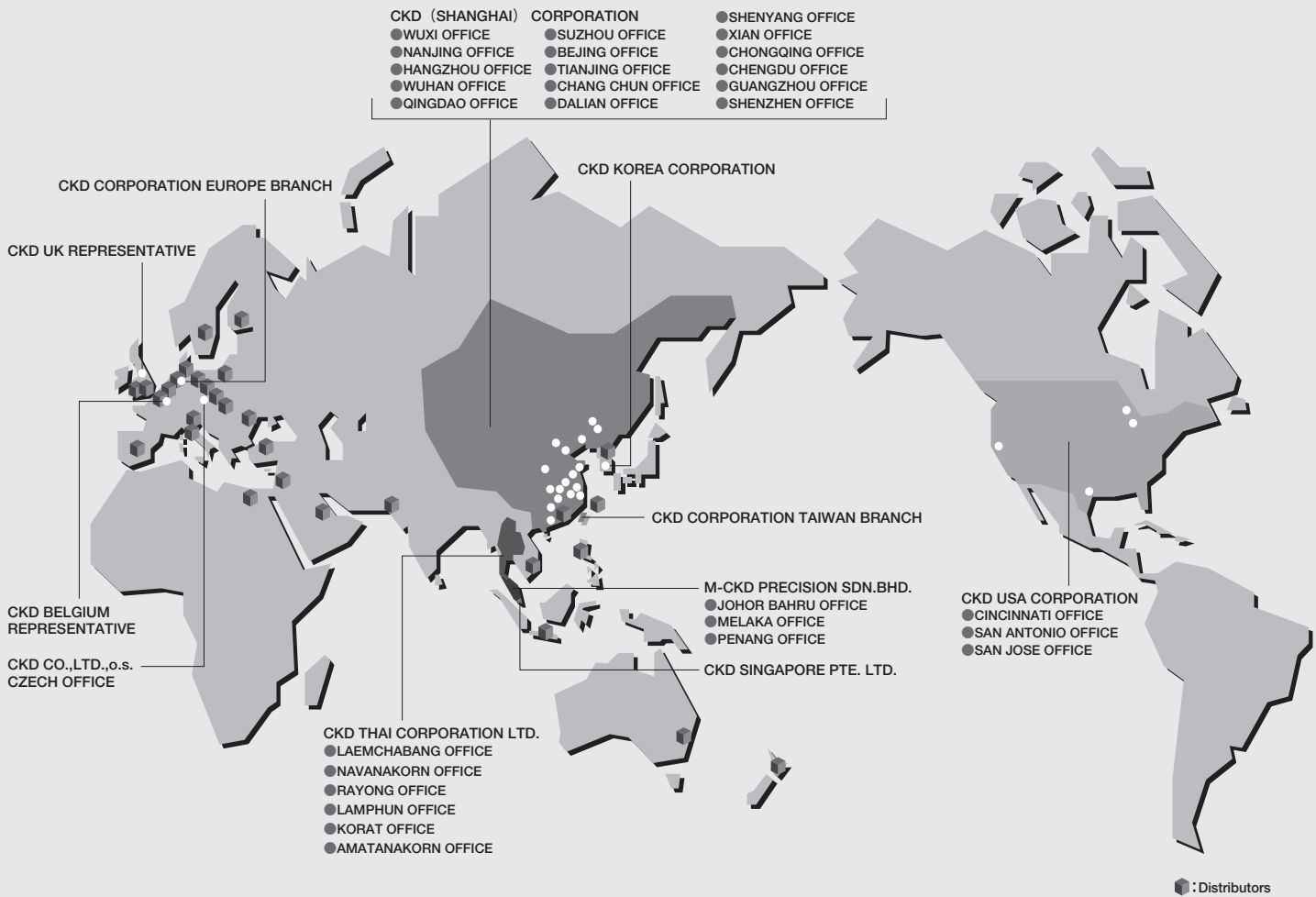

## CKD Corporation

- OVERSEAS DPT. SALES DIV. 2-250 Uji Komaki, Aichi 485-8551, Japan
- PHONE +81-(0)568-74-1336 FAX +81-(0)568-77-3412

### U.S.A

#### CKD USA CORPORATION

- HEADQUARTERS
- 4080 Winnetka Avenue, Rolling Meadows, IL 60008 USA
- PHONE +1-847-368-0539 FAX +1-847-788-0575

### EUROPE

#### CKD EUROPE BRANCH

- De Fruittuinen 28 Hoofddorp 2132NZ The Netherlands
- PHONE +31-(0)23-5541490 FAX +31-(0)23-5541491

### Malaysia

#### M-CKD PRECISION SDN.BHD.

- HEADQUARTERS
- Lot No.6,Jalan Modal 23/2, Seksyen 23, Kawasan, MIEL, Fasa 8, 40300 Shah Alam,Selangor Darul Ehsan, Malaysia
- PHONE +60-(0)3-5541-1468 FAX +60-(0)3-5541-1533

### Thailand

#### CKD THAI CORPORATION LTD.

- SALES HEADQUARTERS-BANGKOK OFFICE
- Suwan Tower, 14/1 Soi Saladaeng 1, North Sathorn Rd., Bangrak, Bangkok 10500 Thailand
- PHONE +66-(0)2-267-6300 FAX +66-(0)2-267-6305

### Singapore

#### CKD SINGAPORE PTE LTD.

- 705 Sims Drive #03-01/02, Shun Li Industrial Complex, 387384 Singapore
- PHONE +65-6744-2623 FAX +65-6744-2486

### Taiwan

#### CKD CORPORATION TAIWAN BRANCH

- Rm.1405, 14F, No.96, Sec.2, Chung Shan N.Rd., Taipei, Taiwan, R.O.C.
- PHONE +886-(0)2-2523-0374 FAX +886-(0)2-2523-5081

Home Page Address <http://www.ckd.co.jp/>

### China

#### CKD (SHANGHAI) CORPORATION

- SALES HEADQUARTERS / SHANGHAI OFFICE
- Room 1903, 333 Jiujiang Road, Shanghai, 200001, China
- PHONE +86-(0)21-63602277 FAX +86-(0)21-63511661

### Korea

#### CKD KOREA CORPORATION

- Room No.1105, 11th FL, The Korea Teachers Pension B/L, 27-2, Yoido-Dong, Youngdeungpo-Gu, Seoul, 150-742, Korea
- PHONE +82-(0)2-783-5201~5203 FAX +82-(0)2-783-5204

The goods and their replicas, or the technology and software in this catalog are subject to complementary export regulations by Foreign Exchange and Foreign Trade Law of Japan.

If the goods and their replicas, or the technology and software in this catalog are to be exported, laws require the exporter to make sure they will never be used for the development or the manufacture of weapons for mass destruction.